



FGD LANDFILL-CCR GROUNDWATER MONITORING WELL NETWORK EVALUATION

Amos Plant
Winfield Road
Putnam County
Winfield, West Virginia

October 5, 2016

**FGD LANDFILL-CCR
GROUNDWATER
MONITORING
NETWORK
EVALUATION**

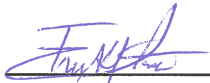

Everett Fortner III, PG
Senior Geologist

Amos Plant
Winfield Road
Putnam County
Winfield, West Virginia

Prepared for:
American Electric Power Service Corporation

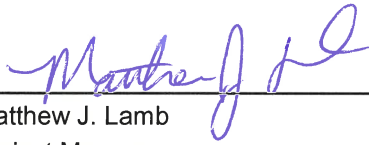

Matthew J. Lamb
Project Manager

Prepared by:
Arcadis U.S., Inc.
100 E Campus View Boulevard
Suite 200
Columbus
Ohio 43235-1447
Tel 614 985 9100
Fax 614 985 9170

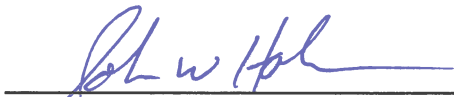

John Holm, PE
Principal Engineer

Our Ref.:
OH015976.0007

Date:
October 5, 2016

This document is intended only for the use of the individual or entity for which it was prepared and may contain information that is privileged, confidential and exempt from disclosure under applicable law. Any dissemination, distribution or copying of this document is strictly prohibited.

CONTENTS

Acronyms and Abbreviations.....	iii
1. Objective	1
2. Background Information.....	2
2.1 Facility Location Description	2
2.2 Description of FGD Landfill CCR Unit.....	2
2.2.1 Landfill Configuration.....	2
2.2.2 Area/Volume.....	2
2.2.3 Construction and Operational History	2
2.2.4 Surface Water Control.....	3
2.3 Previous Investigations.....	3
2.4 Hydrogeologic Setting.....	4
2.4.1 Climate and Water Budget	4
2.4.2 Regional and Local Geologic Setting	5
2.4.2.1 Unconsolidated.....	5
2.4.2.2 Bedrock.....	5
2.4.3 Surface Water and Surface Water Groundwater Interactions.....	5
2.4.4 Water Users.....	6
3. Monitoring Well Network Evaluation	7
3.1 Hydrostratigraphic Units	7
3.1.1 Horizontal and Vertical Position Relative to CCR Unit.....	7
3.1.2 Overall Flow Conditions	7
3.2 Existing Water Quality Conditions	8
3.3 Uppermost Aquifer.....	8
3.3.1 CCR Rule Definition	8
3.3.1.1 Common Definitions	8
3.3.2 Identified Onsite Hydrostratigraphic Unit.....	8
3.4 Review of Existing Monitoring Well Network	8
3.4.1 Overview.....	8
3.4.2 Gaps in Monitoring Network.....	9

FGD LANDFILL-CCR GROUNDWATER MONITORING WELL NETWORK EVALUATION

4. Recommended Monitoring Network	10
4.1 Monitoring Well Network Distribution	10
4.1.1 Down Gradient Locations	10
4.1.2 Up Gradient Locations	10
5. Professional Engineer's Certification	11
6. References	12

TABLES

Table 1. Water Level Data

Table 2. Well Construction Details

FIGURES

Figure 1. Site Location Map

Figure 2. Plant and CCR Unit Location Map

Figure 3. FGD Landfill Layout and Well Locations Map

Figure 4. Cross Section Location Map

Figure 5A. Cross Section A-A'

Figure 5B. Cross Section B-B'

Figure 6. Potentiometric Surface Map, November 22, 2010

Figure 7. Current Monitoring Well Network Map

APPENDICES

A Boring/Well Construction Logs and Closure Information

B Banks Well Report

C Photographic Log

ACRONYMS AND ABBREVIATIONS

AEP	American Electric Power Service Corporation
amsl	above mean sea level
Arcadis	Arcadis U.S., Inc.
CCR	Coal Combustion Residual
CFR	Code of Federal Regulations
CSM	Conceptual Site Model
FGD	flue gas desulfurization
ft	feet
LCS	Leachate Collection System
PVC	polyvinyl chloride

1. OBJECTIVE

This report was prepared by Arcadis U.S., Inc. (Arcadis) for American Electric Power Service Corporation (AEP) to assess the adequacy of the groundwater monitoring well network included in the Coal Combustion Residual (CCR) requirements, as specified in Code of Federal Regulations (CFR) 40 CFR 257.91, for the offsite flue gas desulfurization (FGD) landfill (CCR Unit) located approximately 2 miles northwest of the AEP Generating Plant (Plant) located on Winfield Road in Winfield, West Virginia (**Figure 1**). The CCR requirements include an evaluation of the adequacy of the groundwater monitoring well network to characterize groundwater quality up and down gradient of the CCR unit in the uppermost aquifer and an evaluation of whether the CCR unit meets up to 5 location restrictions. The restrictions include: 1) the base of the CCR unit is 5 feet (ft) above and isolated from the uppermost aquifer, and the CCR unit may not be located 2) in a wetland, 3) within 200 ft of the damage zone of a fault that has displacement during the Holocene, 4) within a seismic impact zone, or 5) in an unstable area. The objective of this report is to present an evaluation of the adequacy of groundwater monitoring well network in the uppermost aquifer at the offsite FGD Landfill (Site). The evaluation of the five location restriction criteria is not included in this report and will be completed under separate cover.

Two regulated CCR units associated with the Plant were identified for review, which include the onsite ash pond system and the offsite FGD landfill (**Figure 2**). The evaluation of the onsite ash pond system is not included in this report and will be completed under separate cover.

Initial evaluation of the monitoring well network was completed in November 2015 and included a review of AEP-provided data associated with previously completed subsurface investigation activities in the vicinity of the FGD Landfill, as well as publically-available geologic and hydrogeologic data. Based on the initial evaluation, the monitoring network was expanded to utilize wells and piezometers that already existed at the Site. The following report presents the current Conceptual Site Model based on historical Site information including geologic and hydrogeologic data. This report also includes a description of the uppermost aquifer and the current monitoring well network. The monitoring well network was determined to adequately cover the up and down gradient areas of the landfill in the uppermost aquifer; therefore, the report objective has been met.

2. BACKGROUND INFORMATION

The following section provides background information for the AEP Amos Generating Plant FGD landfill.

2.1 Facility Location Description

The FGD Landfill is located in Putnam County approximately 2 miles northwest of the Plant and approximately three-quarters of a mile west of Winfield Road (WV 817) (**Figures 1 and 2**). The Site occupies approximately 258 total acres. The landfill is located in an isolated area, with surrounding land use predominantly residential and agriculture

2.2 Description of FGD Landfill CCR Unit

The following section will discuss the landfill configuration, area, volume, construction and operational history, and surface water control associated with the FGD Landfill.

2.2.1 Landfill Configuration

The landfill location consists of a northern and southern valley surrounded on all sides by ridges. The northern and southern valleys are separated by a topographic high point. The surface of the waste will be covered with 2 ft of low-permeability compacted soil and vegetated with grass cover as construction at each landfill cell is completed. Currently, final cover has not been placed on any section of the landfill. General construction of the landfill is further detailed in the *Class F Industrial Landfill Facility Application* for the Site (GAI, 2006).

2.2.2 Area/Volume

The total area of the Site is approximately 258 acres which includes both disposal and non-disposal use. The current permitted area for disposal is 211 acres, with a permitted waste capacity of approximately 38.6 million cubic yards (**Figure 3**).

2.2.3 Construction and Operational History

In March 2006, AEP submitted the *Class F Industrial Landfill Facility Application* (GAI, 2006) to West Virginia Department of Environmental Protection. The application was approved and landfilling activities began in April 2009 according to Appendix N of the landfill application (GAI, 2006). Landfill construction is planned for 10 individual sequences (i.e. cells), and the designed disposal rate is 2.5 million cubic yards per year. With a maximum design capacity of 38.6 million cubic yards, the landfill design life is approximately 15.4 years (GAI, 2006). The landfill is currently filling cells 1, 2 and 3 in the southern valley.

During landfill construction, a liner is placed at the base of each cell. This liner is described in detail in *Class F Industrial Landfill Facility Application* (GAI, 2006). In general, the landfill liner consists of the following layers:

- Groundwater interceptor drainage system
- 12-inches of compacted or in-place clayey-silt subbase
- 18-inches of compacted clay liner
- 30-mil polyvinyl chloride (PVC) geomembrane
- Leachate Collection System (LCS)
- 18-inches of protective cover (typically bottom ash, potentially WVDOT mortar sand or gypsum)

The CCR byproducts from the three coal-fired generating units at the Plant (Unit 1 through Unit 3) are placed in the landfill. These waste products include fly ash, bottom ash, FGD (synthetic gypsum), and FGD purge stream treatment solids (limestone inerts and solids). A majority of these products are transported from the Amos Plant to the offsite dry handling system via pipelines, which is located immediately adjacent to the landfill. Dry conditioned fly ash from the silo and FGD products are dried and caked at this facility before being trucked to the landfill for disposal. Fly ash is trucked directly from the Amos Plant to the landfill via a private haul road for direct disposal. The landfill is also permitted to receive CCR byproducts from the AEP Plants at Clinch River, Glen Lyn, Mountaineer, Sporn, and Kanawha River (GAI, 2006).

2.2.4 Surface Water Control

Surface water control at the Site is discussed in detail in *Class F Industrial Landfill Facility Application* (GAI, 2006). Structures are in place at the Site that control surface runoff and infiltration of surface runoff.

Surface runoff is managed through a series of collection channels, sediment traps, and pipe culverts that channel flow to 4 sediment collection ponds around the perimeter of the site. Additionally, active areas of the landfill are equipped with vertical chimney drains to capture surface water flow across waste. These vertical drains divert water to the LCS component of the landfill liner, which is a geo-composite drainage net consisting of a high-density polyethylene geo-net with needle-punched nonwoven geotextiles heat-bonded to its upper and lower surfaces draining to a network of perforated PVC pipes. The LCS channels leachate and surface flow in active landfilling areas to the leachate pond at the mouth of the southern valley (GAI, 2006). Sedimentation ponds are located in the northwest, southwest, and southeast portions of the landfill. A sedimentation pond is located along the eastern side of the landfill near the divide between the north and south valleys.

2.3 Previous Investigations

Prior to submission of the *Class F Industrial Landfill Facility Application* in March 2006, GAI Consultants, Inc., in coordination with AEP, performed a site investigation to characterize the conditions at the proposed landfill facility. These investigations included drilling through soil and into rock, split barrel soil sampling and standard penetration testing, undisturbed soil sampling (Shelby tubes), continuous rock coring (where appropriate), and pump or packer testing of select rock units (GAI, 2006).

Soil samples were analyzed for geotechnical parameters to assist with general site characterization and stability analyses. These parameters include grain size distribution, Atterberg limits, specific gravity,

moisture content, compaction, permeability, cation exchange capacity, and X-Ray Diffraction characteristics. Additionally, soil samples were analyzed for physical properties at a proposed onsite borrow site for liner quality determination (GAI, 2006).

During the site investigation, piezometers were installed in 23 of 25 soil borings advanced in the projected landfill footprint. Ten 2-inch PVC monitoring wells were also installed, generally around the perimeter of the proposed extent of fill. Groundwater samples were collected from monitoring wells in an effort to characterize background water quality.

2.4 Hydrogeologic Setting

The geologic setting surrounding the Site consists of ridges formed by the Pennsylvanian age Monongahela and Conemaugh Formations. The Monongahela and Conemaugh Formations consist of sandstones, shales, limestones, and coal. These rocks have been fractured as stress on the rocks declined during erosion, leading to expansion and a system of stress relief fractures throughout the bedrock. Groundwater occurrence at the Site is primarily in these stress relief fractures, which are nearly vertical with attitude angles ranging from 75° to near 90°. These fractures occur in sets that are oriented roughly parallel and perpendicular to one another, but not necessarily to the valley walls. Bedrock groundwater flow generally follows surface topography, and is generally downslope of the ridge towards the valley floors (GAI, 2006).

Unconsolidated deposits on top of the bedrock consist primarily of weathered bedrock and residuum, with some colluvial deposits consisting of weathered rock, sand, silt, and clay. In valley bottoms, the unconsolidated sediments can be saturated with perched groundwater at the soil-rock interface. These localized areas of perched groundwater generally flow down-valley along the top of rock, and are connected to the stress relief fracture system (GAI, 2006).

These features are further illustrated on two lines of cross section that were prepared by AEP with modifications through the FGD landfill, both lines trending from southwest to northeast. One cross section extends through the southern valley of the landfill (A to A') and the other cross section extends through the northern valley of the landfill (B to B'). The cross section location map is included as **Figure 4** and the cross sections are included as **Figure 5a** (A to A') and **Figure 5b** (B to B'). Boring logs and well construction diagrams are included in **Appendix A**.

2.4.1 Climate and Water Budget

The climate of Winfield, West Virginia is characterized as humid continental with an average rainfall of approximately 40 inches annually. The average maximum temperature is 66 °F and the average minimum temperature is 44 °F based on information from Southeast Regional Climate Center (SERCC, 2015).

The results of a numerical water budget analysis performed as part of the March 2006 *Class F Industrial Landfill Facility Application* is described in detail in Appendix I of that application (GAI, 2006). The primary objective of this analysis was to estimate the average annual leachate production and estimate the maximum leachate head within the landfill liner system. Using site-specific climate, slope, and soil

characteristics, it was determined that maximum average daily heads, maximum daily peak heads, and average annual leachate heads were all within acceptable ranges (GAI, 2006).

2.4.2 Regional and Local Geologic Setting

2.4.2.1 Unconsolidated

The Site is located in the Appalachian Plateau physiographic province, and unconsolidated soils are limited in extent and are residual and colluvial in origin. Soils in lower topographic areas (i.e. valleys) consist of sand, silt, or clay with increasing rock fragments with depth (colluvium), and grade to weathered bedrock (residuum) with depth. Further up the ridges, soils are composed mainly of residuum. Unconsolidated material is thickest in the valley floors, and average soil thickness is approximately 11 ft (GAI, 2006).

2.4.2.2 Bedrock

The primary regional bedrock units encountered are Pennsylvanian age sedimentary rocks of the Monongahela Formation and Conemaugh Formation, in descending order from youngest to oldest. The depositional environment for these formations is characterized by a gradually subsiding shallow sea with alternating marine and freshwater strata. The sedimentary package associated with the Monongahela and Conemaugh Formations consists of alternating shale and sandstone units, with occasional thin limestone beds. Several coal horizons are present in the region and often serve as marker beds for unit identification. The principal marker bed in the region is the Pittsburg Coal, which marks the transition from the Monongahela and Conemaugh Formations. However, the Pittsburg Coal is not represented in Site borings (GAI, 2006).

The Monongahela Formation is found capping the hills surrounding the Site. It consists of claystones and sandstones, and to a lesser extent silt shales and siltstones, which have varying degrees of thickness laterally, making correlation difficult (GAI, 2006). Bedrock occurrence is illustrated on both cross sections (**Figures 5a** and **5b**) and detailed in boring logs included in **Appendix A**.

Interpretations regarding shallow geologic structures are based on mapping of the Pittsburg Coal. The Parkersburg Syncline and the Byrnside Anticline appears to dip to the north-northwest through the site. Bedding planes in the site have a strike to the east-northeast and dip to the north-northwest at approximately 20 ft per mile (GAI, 2006).

Deeper bedrock units produce oil and gas. Associated oil and gas wells are located in the vicinity of the FGD Landfill along with wells located within the landfill footprint (079-00611 and 079-00722). These two oil and gas wells were closed in 2007 and 2006, respectively. Available information on the closure is provided in **Appendix A**.

2.4.3 Surface Water and Surface Water Groundwater Interactions

There are intermittent streams in both the northern and southern area of the Site, Lick Run and Little Hurricane Creek. Groundwater flows following topographic relief and is generally in the direction of each of these creeks. However, sedimentation, leachate, and stormwater ponds have been constructed

around the perimeter of the landfill. The design specifications of these ponds is described in detail in the *Class F Industrial Landfill Facility Application* (GAI, 2006). Groundwater flow, as well as surface water runoff that contacts active landfill areas, is directed to the leachate ponds via the LCS component of the landfill liner. Runoff that contacts covered landfill areas, disturbed borrow areas, or undisturbed areas is contained in the sediment collection ponds which ultimately discharge to either Little Hurricane Creek or Lick Run via principal or emergency spillways (GAI, 2006).

2.4.4 Water Users

There are no active groundwater production wells at the Site. In 2014, a water well inventory for the Amos Plant indicated no information regarding the use of wells located in the vicinity of the Site was available (Banks, 2014). However, the wells that were identified are registered with the United States Geological Survey and appear to be used for groundwater monitoring. Six of the ten well locations referenced in that report are located on or immediately adjacent to the Plant. Of those wells not obviously related to the Plant, one is located approximately 1,500 ft west of the Plant's onsite ash pond system. The other three well locations are located approximately 3,500 to 5,000 ft south of the Plant's onsite ash pond system (**Appendix B**).

3. MONITORING WELL NETWORK EVALUATION

An initial evaluation of the monitoring well network present at the Site was performed in November 2015 to determine if any of the wells were viable for continued use as part of the groundwater monitoring well network or also retained as part of a larger groundwater hydraulic monitoring well network. As part of this review, hydrogeologic conditions were evaluated to determine if the uppermost aquifer unit had an adequate monitoring well network. The evaluation was completed in accordance with 40 CFR 257.91 to have an established monitoring well network that effectively monitors the uppermost aquifer up gradient and down gradient of the Site. No additional monitor wells were recommended for installation, but the network was augmented to include existing piezometers for the purpose of hydraulic monitoring. Up gradient wells represent background groundwater quality and the down gradient wells are placed down gradient of the CCR unit boundary to monitor water quality.

3.1 Hydrostratigraphic Units

3.1.1 Horizontal and Vertical Position Relative to CCR Unit

The uppermost aquifer at the Site is defined by the saturated portion of the stress relief fracture system and is independent of lithologic unit. Stress relief fractures occur in both the Conemaugh and Monongahela Formations. Stress relief fractures are likely hydraulically connected with deeper open horizontal bedding planes. In similar stress relief fracture systems, the aquifers are generally unconfined but water levels in wells can exhibit confined behavior in valley floors if low-transmissivity sediments (i.e. clay) are present (USGS 1981). The uppermost aquifer is horizontally continuous across the entire site.

The upper limit of the uppermost aquifer is generally located beneath the original bedrock surface prior to landfill construction. The potentiometric surface occurs at depths as shallow as 1 ft below the soil-rock interface (beneath valley walls) to nearly 90 ft below the soil-rock interface (beneath ridgetops). This is illustrated on cross sections A to A' and B to B' (**Figures 5a** and **5b**).

There are perched (discontinuous) groundwater zones, limited to areas at the western ends of the northern and southern valleys, that are likely hydraulically connected to the underlying stress relief fracture system. Monitoring wells MW-1 (southern valley), and MW-5 (northern valley) are screened in the perched zone. However, these zones are not considered the uppermost aquifer as they are limited in extent, discontinuous, and are located beyond the lateral extent of landfilled material. Within the limits of the landfill, underdrains located at various depths beneath the landfill liner prevent an intermittent, recurring, or sustained hydraulic connection between any portion of the base of the CCR unit and the uppermost aquifer due to normal fluctuations in groundwater elevation (GAI, 2006).

3.1.2 Overall Flow Conditions

Groundwater flow at the Site occurs within the stress relief fracture system (i.e. uppermost aquifer). Fractures in this system are hydraulically connected via open bedding planes, and groundwater flow directions generally follow topography from ridges towards the valley floor and out the northern and southern valley mouths. Perched groundwater in the valley mouths flows along the soil-rock interface.

Available groundwater elevations are summarized on **Table 1** for the November 22, 2010 well gauging event. These potentiometric contours are depicted on **Figure 6**.

Packer testing was conducted during piezometer and well installations in 2005 in order to estimate hydraulic properties of the fractured bedrock. Reported hydraulic conductivity estimates from these tests in the uppermost aquifer ranged from 10^{-3} to 10^{-6} centimeters per second (GAI, 2006). No hydraulic testing data is available for perched groundwater in the valley floor.

3.2 Existing Water Quality Conditions

3.3 Uppermost Aquifer

3.3.1 CCR Rule Definition

Per 40 CFR 257.60(a), new CCR landfills, existing and new CCR surface impoundments, and all lateral expansions of CCR units must be constructed with a base that is located no less than 1.52 meters (5 ft) above the upper limit of the uppermost aquifer, or must demonstrate that there will not be an intermittent, recurring, or sustained hydraulic connection between any portion of the base of the CCR unit and the uppermost aquifer due to normal fluctuations in groundwater elevations (including the seasonal high conditions).

The CCR rule definition of the uppermost aquifer under 40 CFR 257.53 is the geologic formation nearest the natural ground surface that is an aquifer, as well as lower aquifers that are hydraulically interconnected with this aquifer within the facility's property boundary. Upper limit is measured at a point nearest to the natural groundwater surface to which the aquifer rises during the wet season.

3.3.1.1 Common Definitions

An aquifer is commonly defined as a geologic unit that stores and transmits water (readily or at sufficient flow rates) to supply wells and springs (USGS, 2015; Fetter, 2001). The uppermost aquifer is considered the first encountered aquifer nearest to the CCR unit.

3.3.2 Identified Onsite Hydrostratigraphic Unit

The identified Site hydrostratigraphic unit is the saturated portion of the stress relief fracture system, which is considered the uppermost aquifer at the Site. The uppermost aquifer is not known to be used locally for groundwater supply or industrial water use.

3.4 Review of Existing Monitoring Well Network

3.4.1 Overview

The Site was visited by Arcadis and AEP personnel on August 11, 2015 to review existing well network conditions and locations. The well network was evaluated and is sufficient in both minimum quantity of monitoring wells (i.e. 3 down gradient, 1 up gradient) and distribution to accurately represent background

water quality and the quality of groundwater passing the waste boundary of the CCR Unit, per 40 CFR 257.91. A well construction table that summarizes the location, ground surface elevation, borehole depth, installation date, and associated well construction details of the monitoring well network is included as **Table 2**. As presented in **Table 2**, wells included in the monitoring network have been designated as up or down gradient. The wells that are gray shaded on **Table 1** and **2** and **Figure 3** were closed. Available closure information is provided in **Appendix A** from the West Virginia Department of Environmental Protection (WVDEP). For monitoring wells MW-3 and MW-3RA and piezometers 0503, 0504, 0507 and 0514; no information was available. These monitoring wells and piezometers are assumed to have been closed following WVDEP guidelines. Photo documentation of the located wells during the August 11, 2015 site visit is provided in **Appendix C**.

Spatially, the network as illustrated on **Figure 7** is distributed around the entire Site and is sufficient up gradient and down gradient as specified in 40 CFR 257.91. The well screen intervals were placed within water-bearing fractures and are located in both the Monongahela and Conemaugh Formations.

3.4.2 Gaps in Monitoring Network

No data gaps are identified with the existing monitoring well network.

4. RECOMMENDED MONITORING NETWORK

The network meets specifications stated in 40 CFR 257.91. Recommended groundwater monitoring objectives utilizing existing wells are further discussed and will provide an adequate understanding of seasonal and temporal fluctuations in groundwater quality, hydraulics, and groundwater flow at the Site.

4.1 Monitoring Well Network Distribution

The groundwater quality monitoring network at the Site consists of 9 wells as represented on **Table 2** and **Figure 7**. Additionally, all available piezometers listed on **Table 2** will be gauged, along with the 9 groundwater water quality monitoring wells, for the purposes of groundwater flow analysis.

4.1.1 Down Gradient Locations

Monitoring wells down gradient in the south valley (MW-1, MW-2) and north valley (MW-4, MW-5) constitute the down gradient groundwater quality monitoring locations (**Figure 7**).

4.1.2 Up Gradient Locations

Monitoring wells located along the western (MW-6), southern (MW-7R), eastern (MW-8), and northern (MW-9, MW-10) CCR boundary constitute the up gradient groundwater quality monitoring locations (**Figure 7**).

5. PROFESSIONAL ENGINEER'S CERTIFICATION

I, John W. Holm, certify that this report was prepared under my direction and supervision, and that the information contained herein is true and accurate to the best of my knowledge. Based on my experience and knowledge of the site, the proposed groundwater monitoring system will be adequate to meet the requirements of 40 CFR Part 257.91.

John W Holm
Printed Name of Registered Professional Engineer

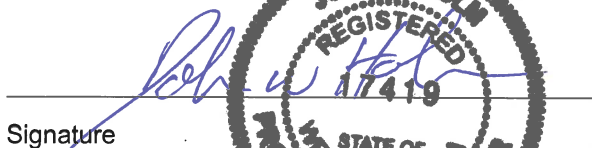
Signature

17419 WV 10/5/16
Registration No. Registration State Date

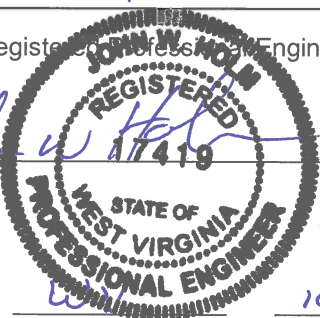

6. REFERENCES

- Banks Environmental Data, Inc. 2014. Water Well Report, AEP Water Well Inventory, Amos Plant, ES-112028.
- Fetter, Charles Willard, and C. W. Fetter. 2001. Applied hydrogeology. Vol. 3. No. 3. Upper Saddle River: Prentice hall.
- GAI Consultants, Inc. 2006. Class F Industrial Landfill Facility Application, John E. Amos Landfill, John E. Amos Plant, Winfield, West Virginia, GAI Project Number: C040384.40.
- Southeast Regional Climate Center. 2015. Historical Climate Summaries, Winfield Locks, West Virginia, <http://www.sercc.com>, Query conducted by Mr. Josh Roberts of Arcadis on October 6, 2015.
- United States Geological Survey (USGS). 1981. Water-Supply Paper 2177, Hydrologic Effects of Stress-Relief Fracturing in an Appalachian Valley.
- United States Geological Survey (USGS), Aquifers and Groundwater. 2015. Available online at www.usgs.gov.

TABLES



Table 1
Water Level Data
AEP Amos Generating Plant - FGD Landfill
Winfield, West Virginia

Well ID	Nov-10 GW Elev ft amsl
<u>Monitor Wells</u>	
MW-1 ^a	701.81
MW-2 ^a	668.35
MW-3	
MW-3R ^a	779.77
MW-3RA	
MW-4 ^a	656.25
MW-5 ^a	670.50
MW-6 ^a	863.54
MW-7	
MW-7R ^a	782.28
MW-8 ^a	915.20
MW-9 ^a	897.50
MW-10 ^a	810.15
<u>Piezometers</u>	
0501	
0502	
0503	
0504	
0505	
0506 ^a	668.16
0507	
0508	
0509	
0510	
0511	
0512 ^a	781.07
0513 ^a	781.24
0514	
0515	
0517 ^a	894.68
0519 ^a	905.43
0520 ^a	656.86
0521 ^a	948.43
0522 ^a	833.37
0523 ^a	668.17
0524 ^a	693.53
0525 ^a	675.01

Notes:

Shaded - well not verified or closed

Elevation in feet above mean sea level.

a. Source: AEP DWG. No. 13-30500-12-E

amsl = above mean sea level

bls = below land surface

Elev = elevation

ft = feet

GW = groundwater

Table 2
Well Construction Details
AEP Amos Generating Plant - FGD Landfill
Winfield, West Virginia

Well ID	Hydraulic Monitoring Only	Location Description to CCR Unit	Northing ^a	Easting ^a	Ground Surface Elevation	Top of Casing Elevation	Borehole Depth ft bls	Date Installed	Screen Material	Well Diameter inches	Top of Filter Pack		Bottom of Filter Pack		Top of Screen		Bottom of Screen		
											Depth ft bls	Elevation ft amsl	Depth ft bls	Elevation ft amsl	Depth ft bls	Elevation ft amsl	Depth ft bls	Elevation ft amsl	
Monitor Wells																			
Downgradient																			
MW-1 ^b		Southwest	539438.7	1722490.9	709.57	NA	19.0	7/12/2005	screened PVC	2.00	6.0	703.57	19.0	690.57	8.0	701.57	18.0	691.57	
MW-2 ^b		Southwest	539438.3	1722530.7	709.41	NA	62.5	7/12/2005	screened PVC	2.00	37.0	672.41	62.5	646.91	42.0	667.41	62.0	647.41	
MW-3 ^b		Central	541709.8	1724126.1	823.00	NA	32.5	6/27/2005	screened PVC	2.00	9.0	814.00	32.5	790.50	12.0	811.00	32.0	791.00	
MW-3R ^c		Central	542088.2	1724096.2	NA	NA	NA	NA	NA	NA	NA	NA	NA	NA	NA	NA	NA	NA	
MW-3RA ^c		Central	542150.2	1724100.2	NA	NA	NA	NA	NA	NA	NA	NA	NA	NA	NA	NA	NA	NA	
MW-4 ^b		West	542302.5	1721626.9	674.76	NA	78.5	7/7/2005	screened PVC	2.00	53.0	621.76	78.5	596.26	58.0	616.76	78.0	596.76	
MW-5 ^b		West	542299.2	1721658.7	674.84	NA	10.2	7/7/2005	screened PVC	2.00	4.0	670.84	10.2	664.64	5.0	669.84	10.0	664.84	
Upgradient																			
MW-6 ^b		West	540882.8	1722758.8	927.29	NA	91.0	6/23/2005	screened PVC	2.00	55.0	872.29	78.5	848.79	58.0	869.29	78.0	849.29	
MW-7 ^b		South	539657.9	1723948.2	943.15	NA	55.5	6/28/2005	screened PVC	2.00	30.0	913.15	55.5	887.65	32.0	911.15	52.0	891.15	
MW-7R ^c		South	539989.3	1723429.4	NA	NA	NA	NA	NA	NA	NA	NA	NA	NA	NA	NA	NA	NA	
MW-8 ^b		East	542193.8	1725402.8	945.01	NA	60.5	7/11/2005	screened PVC	2.00	30.0	915.01	60.5	884.51	40.0	905.01	60.0	885.01	
MW-9 ^b		Northeast	544204.9	1724522.8	933.39	NA	62.5	6/30/2005	screened PVC	2.00	37.0	896.39	62.5	870.89	42.0	891.39	62.0	871.39	
MW-10 ^b		Northwest	544079.1	1722812.2	909.43	NA	157.0	7/6/2005	screened PVC	2.00	85.0	824.43	157.0	752.43	133.0	776.43	153.0	756.43	
Piezometers																			
0501 ^b		Central	540588.5	1723508.1	759.08	761.33	80.0	4/21/2005	Slotted PVC	0.75	35.0	724.08	53.0	706.08	40.0	719.08	50.0	709.08	
0502 ^b		Central	540563.2	1723508.0	759.46	761.46	22.0	4/21/2005	Slotted PVC	0.75	7.0	752.46	22.0	737.46	11.0	748.46	21.0	738.46	
0503 ^b		Central	540843.8	1723858.6	773.00	777.00	50.0	4/20/2005	Slotted PVC	0.75	34.7	738.30	50.0	723.00	39.7	733.30	49.7	723.30	
0504 ^b		Central	540840.1	1723859.8	775.40	777.30	24.0	4/20/2005	Slotted PVC	0.75	8.2	767.20	24.0	751.40	13.2	762.20	23.2	752.20	
0505 ^b		Central	541325.4	1723551.3	910.89	912.89	200.0	4/27/2005	Slotted PVC	0.75	10.0	900.89	140.0	770.89	117.0	793.89	137.0	773.89	
0506 ^b	X	Southwest	539425.0	1722578.7	709.52	711.77	80.0	4/28/2005	Slotted PVC	0.75	20.0	689.52	70.0	639.52	58.0	651.52	68.0	641.52	
0507 ^b		Southwest	539428.8	1722523.8	709.99	712.49	18.0	4/22/2005	Slotted PVC	0.75	4.0	705.99	18.0	691.99	7.0	702.99	17.0	692.99	
0508 ^b		Central	541997.0	1723377.3	979.22	980.97	200.9	5/3/2005	Slotted PVC	0.75	77.0	902.22	150.0	829.22	127.0	852.22	147.0	832.22	
0509 ^b		Central	541748.7	1724111.6	824.40	826.75	100.0	5/3/2005	Slotted PVC	0.75	20.0	804.40	80.0	744.40	68.0	756.40	78.0	746.40	
0510 ^b	X	West	540879.8	1722795.7	925.74	927.69	250.0	5/10/2005	Slotted PVC	0.75	30.0	895.74	122.0	803.74	100.0	825.74	120.0	805.74	
0511 ^b		Central	541746.9	1724116.4	824.57	826.67	26.0	5/4/2005	Slotted PVC	0.75	3.5	821.07	26.0	798.57	15.5	809.07	25.5	799.07	
0512 ^b		Central	542140.9	1724101.8	784.29	786.29	110.0	5/6/2005	Slotted PVC	0.75	20.0	764.29	54.0	730.29	42.0	742.29	52.0	732.29	
0513 ^b		Central	542140.9	1724101.8	784.29	786.49	19.0	5/6/2005	Slotted PVC	0.75	2.5	781.79	16.0	768.29	4.0	780.29	14.0	770.29	
0514 ^b		Southeast	540555.6	1725145.9	948.40	950.65	150.0	5/12/2005	Slotted PVC	0.75	17.0	931.40	67.0	881.40	55.0	893.40	65.0	883.40	
0515 ^b		South	539572.1	1723680.2	933.64	935.49	250.3	5/16/2005	Slotted PVC	0.75	20.0	913.64	82.0	851.64	70.0	863.64	80.0	853.64	
0517 ^b	X	East	542185.3	1725391.3	945.55	947.35	150.0	3/19/2005	Slotted PVC	0.75	14.0	931.55	56.4	889.15	44.4	901.15	54.4	891.15	
0519 ^b	X	Northeast	543732.9	1725136.5	991.07	992.97	150.5	5/19/2005	Slotted PVC	0.75	15.0	976.07	108.0	883.07	95.0	896.07	105.0	886.07	
0520 ^b		West	542378.4	1721739.8	679.31	681.38	100.0	5/24/2005	Slotted PVC	0.75	34.0	645.31	96.0	583.31	84.0	595.31	94.0	585.31	
0521 ^b	X	North	544199.6	1724054.6	1004.35	1006.48	70.4	5/23/2005	Slotted PVC	0.75	12.4	991.95	70.4	933.95	60.4	943.95	70.4	933.95	
0522 ^b		Northwest	543873.4	1722326.4	901.64	903.54	250.5	5/26/2005	Slotted PVC	0.75	35.0	866.64	155.0	746.64	133.0	768.64	153.0	748.64	
0523 ^b		West	542742.2	1722248.7	969.90	972.30	50.0	5/25/2005	Slotted PVC	0.75	24.0	945.90	50.0	919.90	38.0	931.90	48.0	921.90	
0524 ^b		West	542745.1	1722251.4	696.91	699.14	18.0	5/25/2005	Slotted PVC	0.75	3.0	693.91	18.0	678.91	8.0	688.91	18.0	678.91	
0525 ^b		West	542379.9	1721745.4	679.43	681.48	10.0	5/25/2005	Slotted PVC	0.75	2.0	677.43	10.0	669.43	5.0	674.43	10.0	669.43	

Notes:

Shaded - well not verified or closed

Elevation in feet above mean sea level

a. 1983 West Virginia State Planar Coordinates

b. Source: GAI Consultants. March 2006. Class F Industrial Landfill Facility Application, John E. Amos Landfill, Volume 1, Appendix K - Monitor Well Construction Diagrams.

c. Survey data and boring log not available, coordinates estimated based on AEP DWG. No. 13-30500-11-E.

amsl = above mean sea level

bls = Below land surface

ft = feet

NA = not applicable

FIGURES



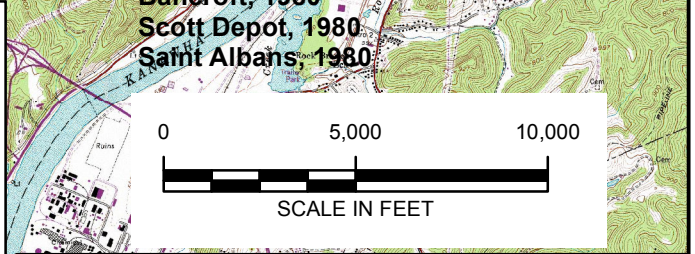
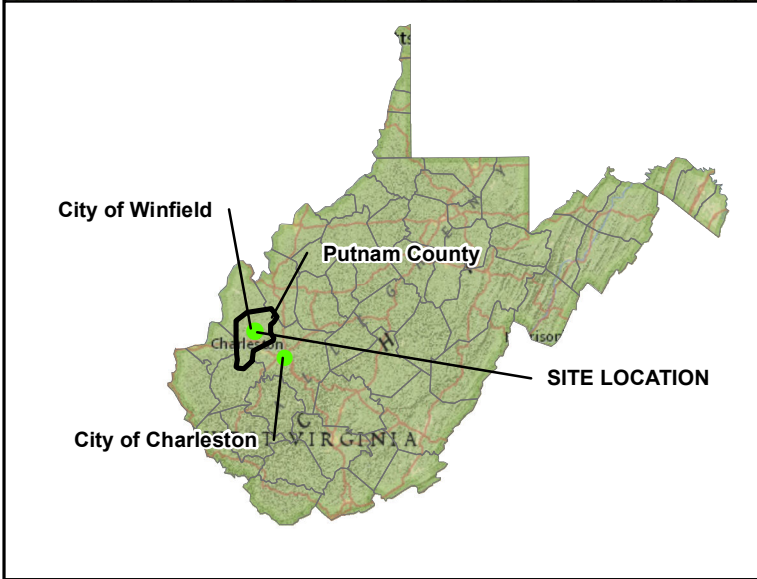
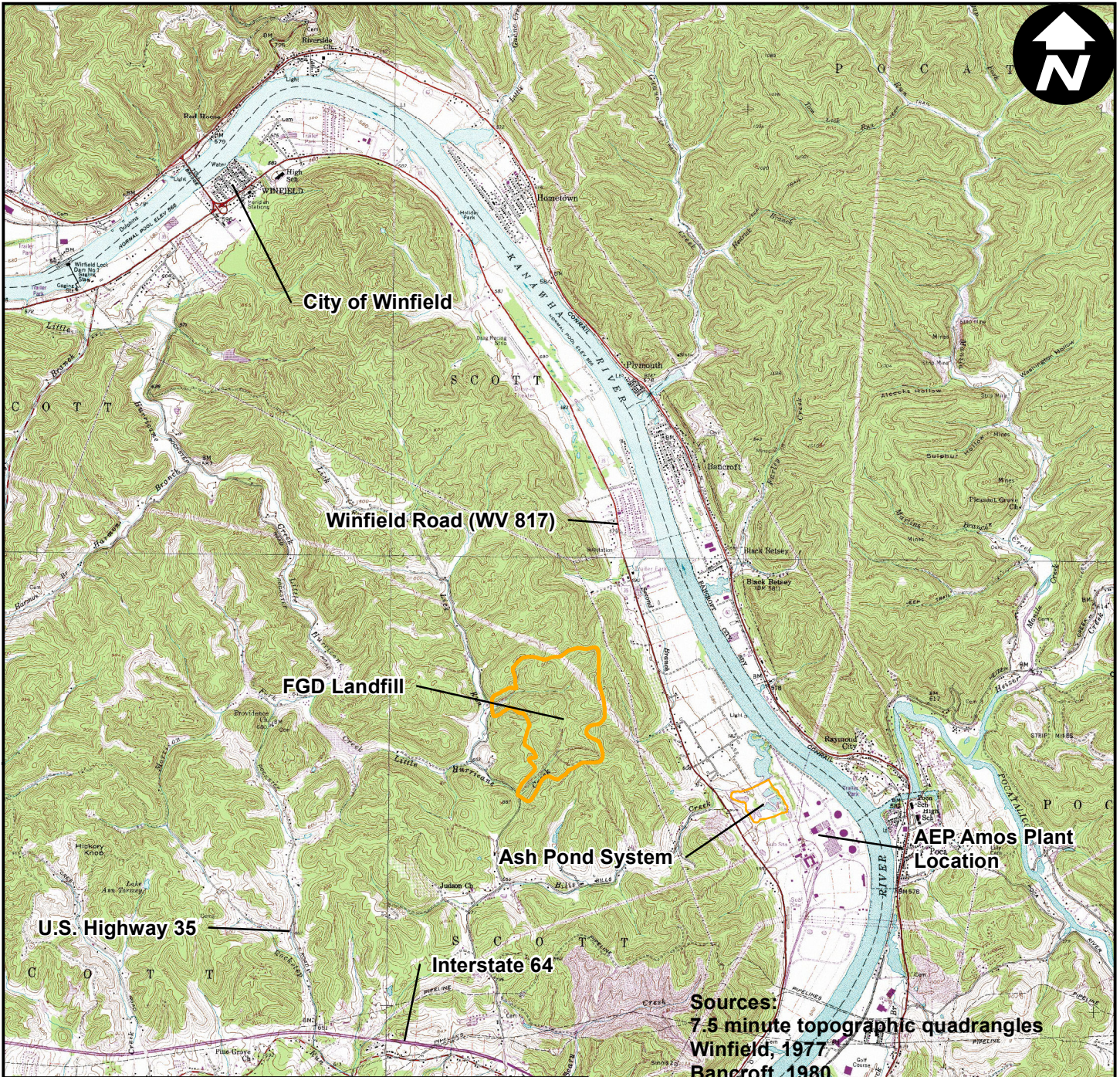

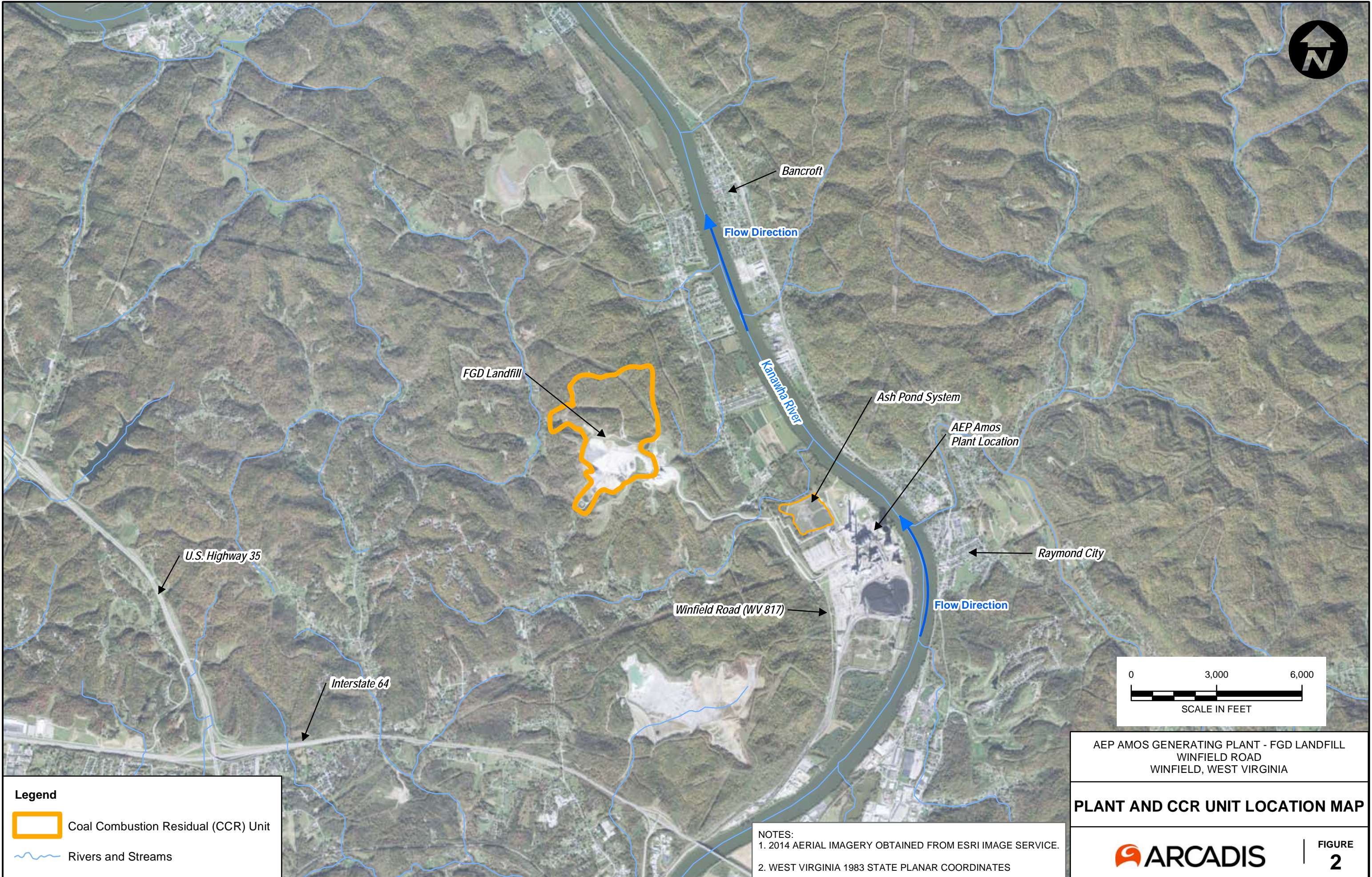

AEP AMOS GENERATING PLANT - FGD LANDFILL
WINFIELD ROAD
WINFIELD, WEST VIRGINIA

SITE LOCATION MAP



City: CITRIX Div/Group: IMDV Created By: K.Ives Last Saved By: webb
OH:015976.0009.0001 (Mountainair Ash Pond)
Z:\GIS\PROJECTS\ENV\AEP\Amos\mxd\Landfill Report\F2_AmosRegionalMap.mxd 11/4/2015 1:22:46 PM

Legend

-  Coal Combustion Residual (CCR) Unit
-  Rivers and Streams

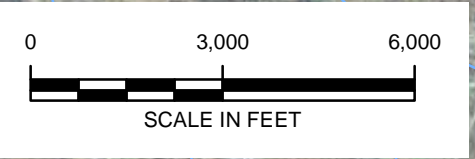

AEP AMOS GENERATING PLANT - FGD LANDFILL
WINFIELD ROAD
WINFIELD, WEST VIRGINIA

PLANT AND CCR UNIT LOCATION MAP

NOTES:

1. 2014 AERIAL IMAGERY OBTAINED FROM ESRI IMAGE SERVICE.
2. WEST VIRGINIA 1983 STATE PLANAR COORDINATES



FIGURE
2

City: CITRIX Div/Group: MIDV Created By: K.Ives Last Saved By: webb
 CH015976.0009.00001 (Mountainview Ash Pond)
 Z:\GIS\PROJECTS\ENV\AEP\amos\mxd\Landfill Report\F3_FGD\Landfill_aerial.mxd 9/15/2016 12:42:16 PM

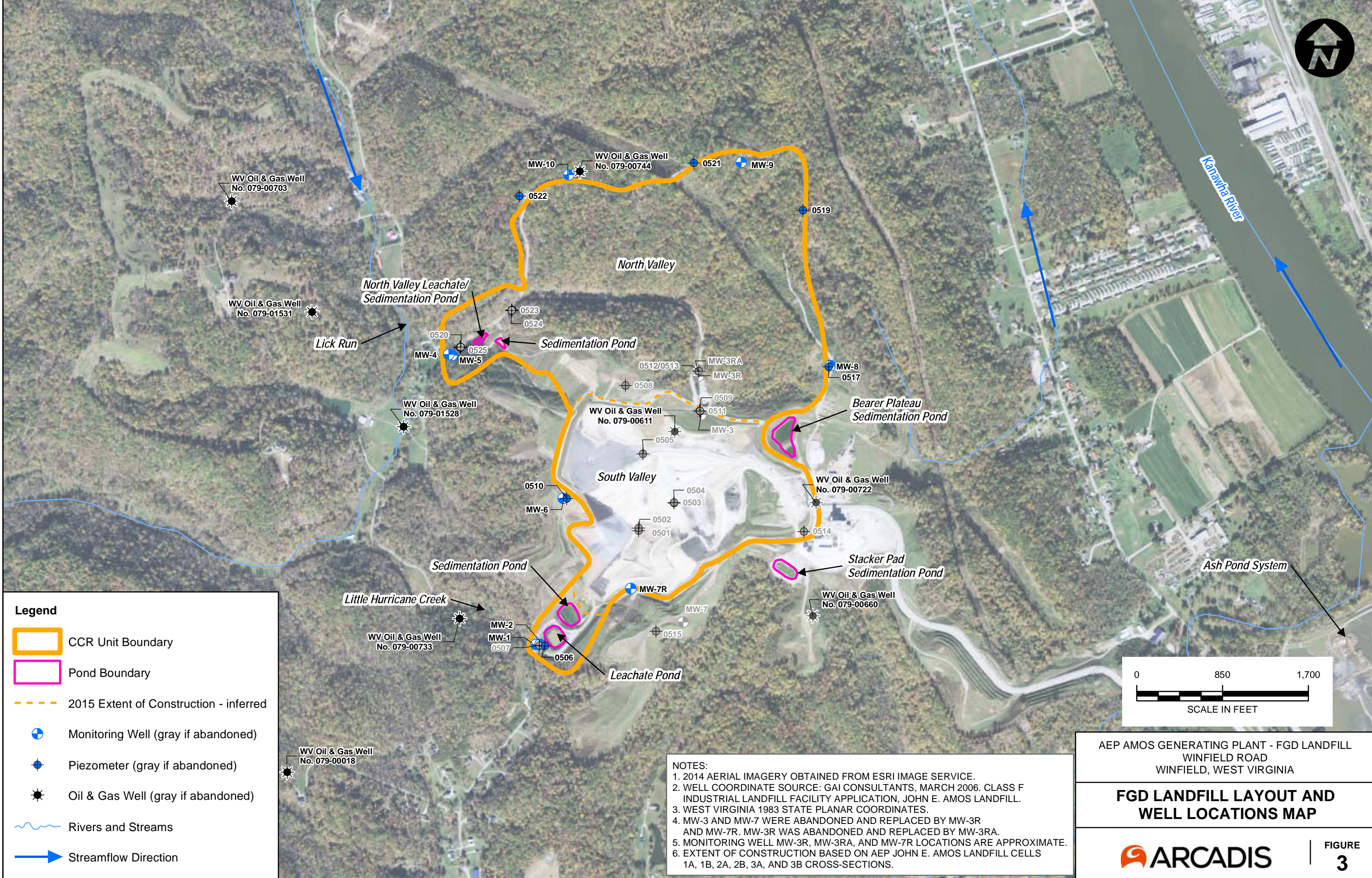

Legend

- CCR Unit Boundary
- Pond Boundary
- 2015 Extent of Construction - inferred
- Monitoring Well (gray if abandoned)
- ⊕ Piezometer (gray if abandoned)
- ★ Oil & Gas Well (gray if abandoned)
- ~ Rivers and Streams
- ➔ Streamflow Direction

NOTES:

1. 2014 AERIAL IMAGERY OBTAINED FROM ESRI IMAGE SERVICE.
2. WELL COORDINATE SOURCE: GAI CONSULTANTS, MARCH 2006. CLASS F INDUSTRIAL LANDFILL FACILITY APPLICATION, JOHN E. AMOS LANDFILL.
3. WEST VIRGINIA 1983 STATE PLANAR COORDINATES.
4. MW-3 AND MW-7 WERE ABANDONED AND REPLACED BY MW-3R AND MW-7R. MW-3R WAS ABANDONED AND REPLACED BY MW-3RA.
5. MONITORING WELL MW-3R, MW-3RA, AND MW-7R LOCATIONS ARE APPROXIMATE.
6. EXTENT OF CONSTRUCTION BASED ON AEP JOHN E. AMOS LANDFILL CELLS 1A, 1B, 2A, 2B, 3A, AND 3B CROSS-SECTIONS.

AEP AMOS GENERATING PLANT - FGD LANDFILL
 WINFIELD ROAD
 WINFIELD, WEST VIRGINIA

FGD LANDFILL LAYOUT AND
 WELL LOCATIONS MAP

FIGURE
3

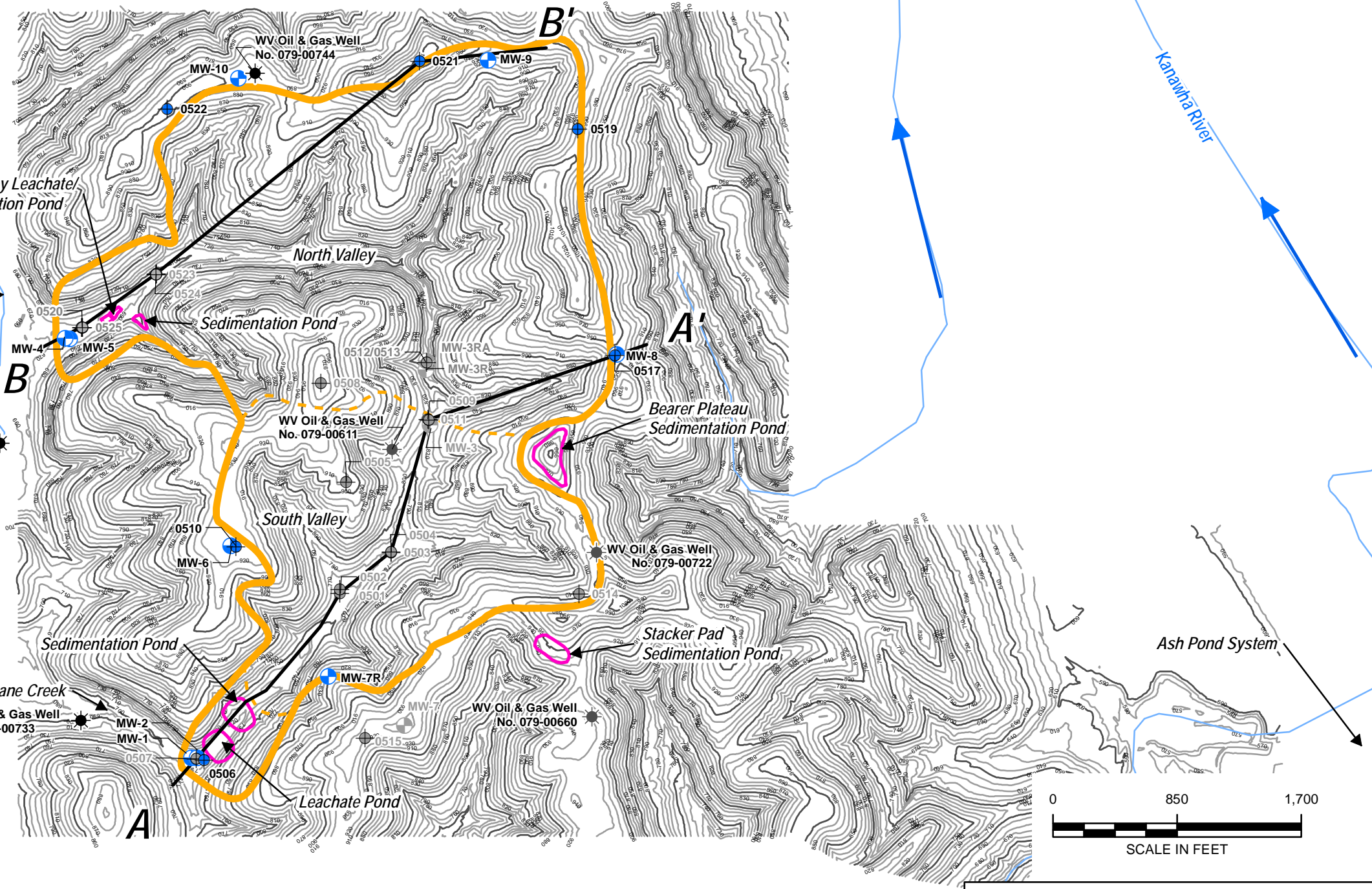

Legend

- CCR Unit Boundary
- Pond Boundary
- 2015 Extent of Construction - inferred
- Monitoring Well (gray if abandoned)
- Piezometer (gray if abandoned)
- Oil & Gas Well (gray if abandoned)
- Cross Section Location
- Rivers and Streams
- Streamflow Direction

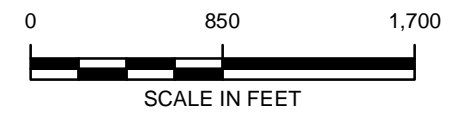

NOTES:

1. TOPOGRAPHY FROM AEP DRAWING 13-30500-11-E. CONTOUR INTERVAL: 10 FEET
2. WELL COORDINATE SOURCE: GAI CONSULTANTS, MARCH 2006. CLASS F INDUSTRIAL LANDFILL FACILITY APPLICATION, JOHN E. AMOS LANDFILL.
3. WEST VIRGINIA 1983 STATE PLANAR COORDINATES.
4. MW-3 AND MW-7R WERE ABANDONED AND REPLACED BY MW-3R AND MW-7R. MW-3R WAS ABANDONED AND REPLACED BY MW-3RA.
5. MONITORING WELL MW-3R, MW-3RA, AND MW-7R LOCATIONS ARE APPROXIMATE.
6. EXTENT OF CONSTRUCTION BASED ON AEP JOHN E. AMOS LANDFILL CELLS 1A, 1B, 2A, 2B, 3A, AND 3B CROSS-SECTIONS.

AEP AMOS GENERATING PLANT - FGD LANDFILL
WINFIELD ROAD
WINFIELD, WEST VIRGINIA

**CROSS SECTION
LOCATION MAP**

ARCADIS

FIGURE
4

City: CITRIX Div/Group: IMDV Created By: K.Ives Last Saved By: webb
OH:015976.0009.00001 (Mountaineer Ash Pond)
Z:\GIS\PROJECTS\ENV\AEP\amos\mxd\Landfill Report\F4_CrossSectionTrend_topo.mxd 9/15/2016 12:45:03 PM

CITY: COLUMBUS, OHIO | DIV: GROUP 1 (MIDV) | DR: R. SMITH | LD: (OP) | PIC: (OP) | PM: (T. FORTNER) | TM: (OP) | LXR: (OP) | ON: "OFF-REF" |
 G:\ENVCAD\Columbus-Ohio\ACT\104015976 - AEP AMOS\0070003 - LANDFILL\104015976 - AMOS LANDFILL\2015-SS01.dwg | LAYOUT: CS.P.B. | SAVED: 3/22/2016 7:08 AM | ACADVER: 19.1S (LMS TECH) | PAGESETUP: --- | PLOTSTYLETABLE: ACAD.CTB | PLOTTED: 8/17/2016 3:25 PM | BY: SMITH, BOB | XREFS:

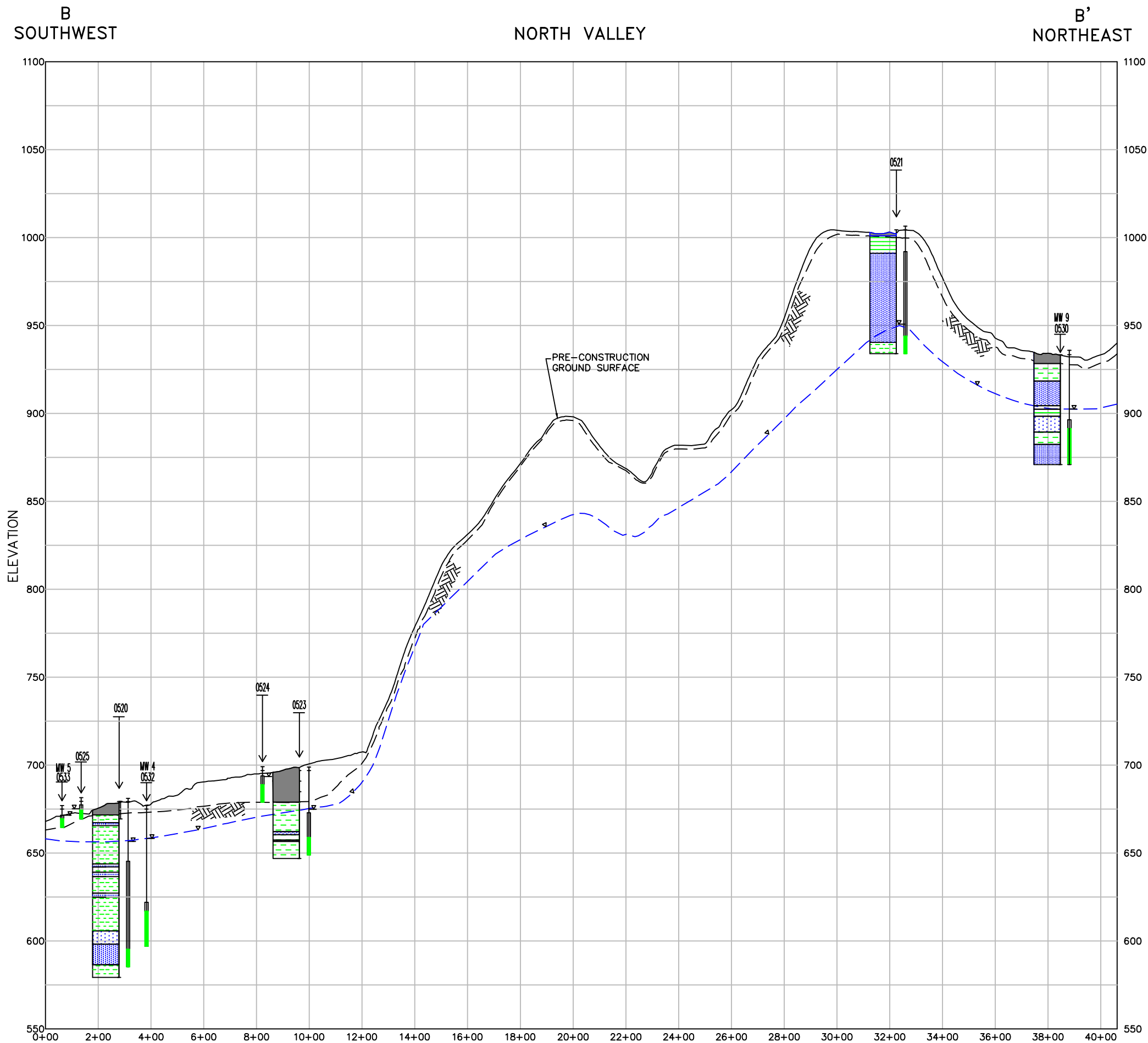

LEGEND:

- SOIL AND DECOMPOSED ROCK
- CLAYSTONE
- SANDSTONE
- SHALE
- SILTSTONE
- INFERRED TOP OF ROCK
- POTENTIOMETRIC SURFACE TRACE
- MW-1 MONITORING WELL NUMBER
 BORING NUMBER
- LINE INDICATES BORING LOCATION
- PVC STICKUP
- BENTONITE SEAL
- SAND PACK
- SCREEN
- BENTONITE SEAL

WATER LEVEL RECORDED IN JULY, 2005

PIEZOMETERS AND MONITORING WELLS

HORIZONTAL SCALE: 1"=400'
VERTICAL SCALE: 1"=60'

NOTES:
 THE HORIZONTAL POSITION OF THE SAMPLED BORING IS CORRECT ON THE CROSS SECTIONS. THE PIEZOMETERS AND MONITORING WELLS HAVE BEEN MOVED OFF LOCATION SO THEIR INFORMATION CAN BE SEEN. THEIR VERTICAL LOCATIONS AND LENGTHS ARE CORRECT.

SOURCE:
 1. PRE-CONSTRUCTION CROSS SECTION: AEP DRAWING No. 13-30500-14-A.

AEP AMOS GENERATING PLANT -FGD LANDFILL
 WINFIELD ROAD
 WINFIELD, WEST VIRGINIA

CROSS SECTION B-B'

ARCADIS | Design & Consultancy
 for natural and built assets

FIGURE
5B

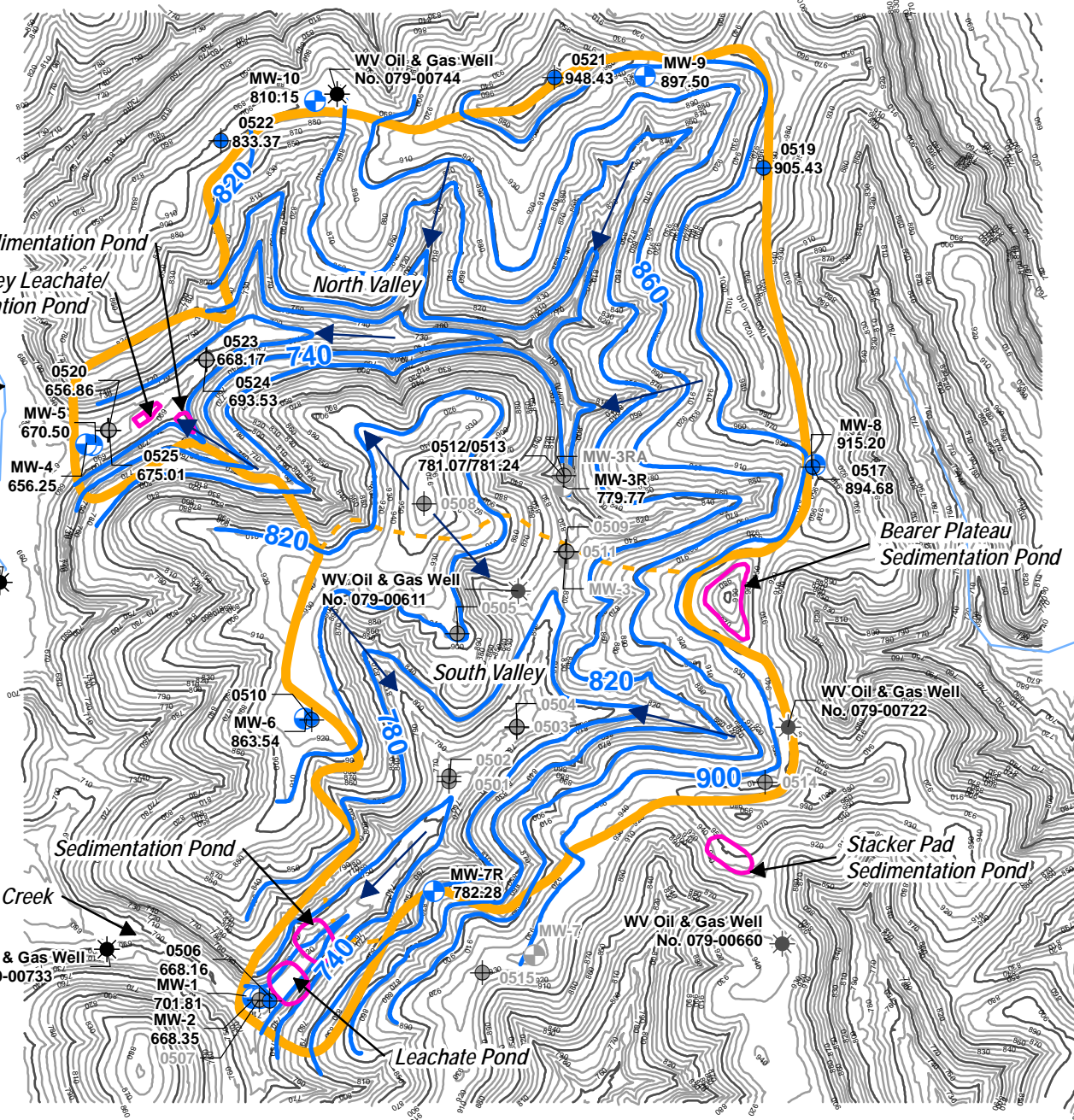

Legend

- CCR Unit Boundary
- Pond Boundary
- 2015 Extent of Construction - inferred
- Monitoring Well (gray if abandoned)
- Piezometer (gray if abandoned)
- Oil & Gas Well (gray if abandoned)
- Rivers and Streams
- Streamflow Direction
- Potentiometric Surface Contour Lines
- Estimated Groundwater Flow Path

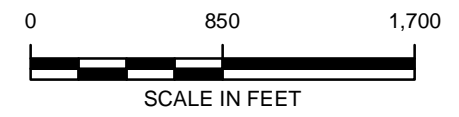

NOTES:

1. TOPOGRAPHY FROM AEP DRAWING 13-30500-11-E. CONTOUR INTERVAL: 10 FEET
2. WELL COORDINATE SOURCE: GAI CONSULTANTS, MARCH 2006. CLASS F INDUSTRIAL LANDFILL FACILITY APPLICATION, JOHN E. AMOS LANDFILL.
3. WEST VIRGINIA 1983 STATE PLANAR COORDINATES.
4. MW-3 AND MW-7 WERE ABANDONED AND REPLACED BY MW-3R AND MW-7R. MW-3R WAS ABANDONED AND REPLACED BY MW-3RA.
5. MONITORING WELL MW-3R, MW-3RA, AND MW-7R AND LOCATIONS ARE APPROXIMATE.
6. EXTENT OF CONSTRUCTION BASED ON AEP JOHN E. AMOS LANDFILL CELLS 1A, 1B, 2A, 2B, 3A, AND 3B CROSS-SECTIONS.

AEP AMOS GENERATING PLANT - FGD LANDFILL
WINFIELD ROAD
WINFIELD, WEST VIRGINIA







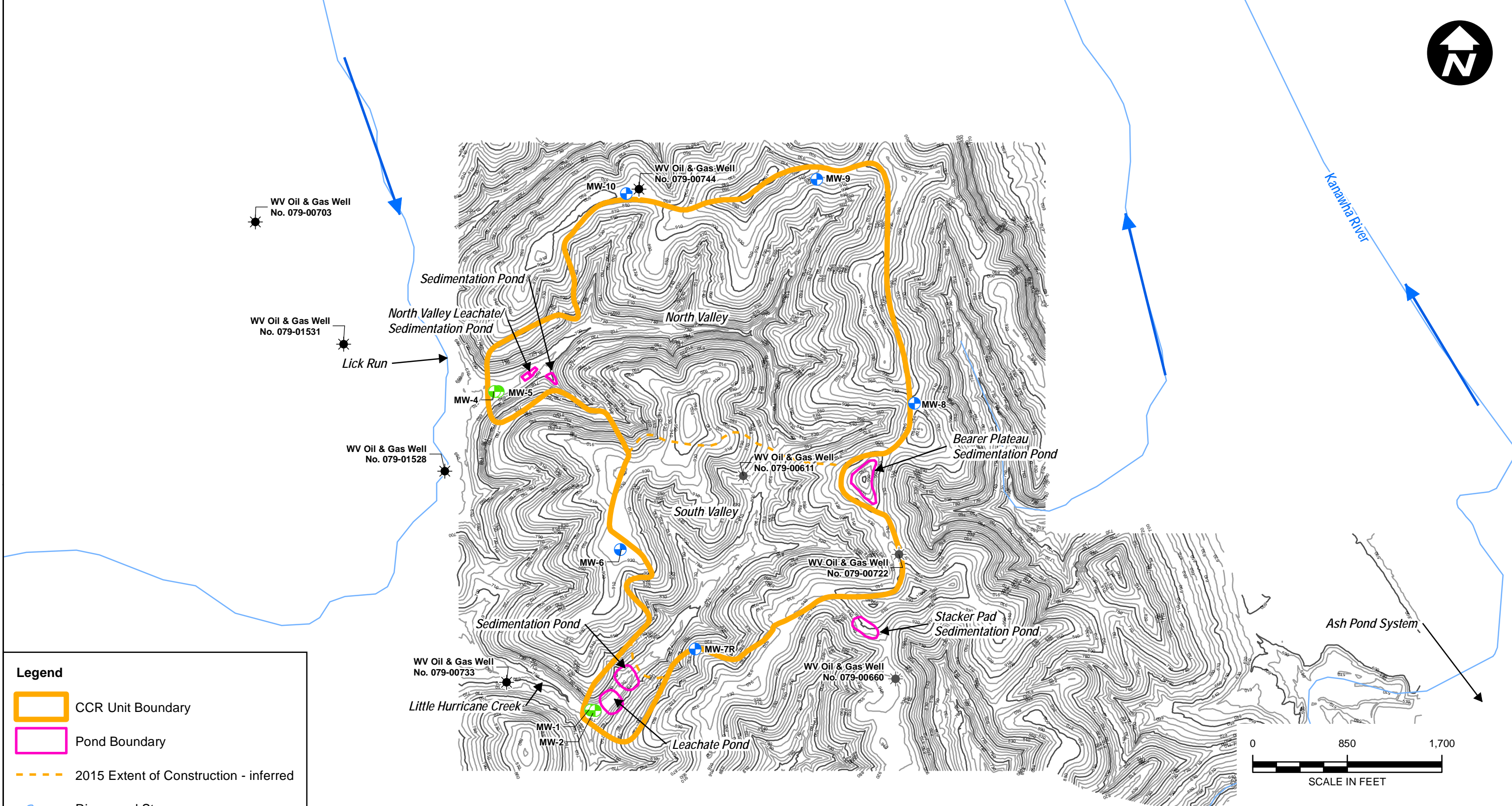

**POTENTIOMETRIC SURFACE MAP
NOVEMBER 22, 2010**

ARCADIS | **FIGURE 6**

City: CITRIX Div/Group: IMDV Created By: K.Ives Last Saved By: webb
OH:015976.0009.00001 (Mountainair Ash Pond)
Z:\GIS\PROJECTS\ENV\AEP\amos\mxd\Landfill Report\F6_POTmap_topo.mxd 9/15/2016 12:46:56 PM



Legend

-  CCR Unit Boundary
-  Pond Boundary
-  2015 Extent of Construction - inferred
-  Rivers and Streams
-  Streamflow Direction
-  Upgradient Monitoring Well
-  Downgradient Monitoring Well
-  Oil & Gas Well (gray if abandoned)

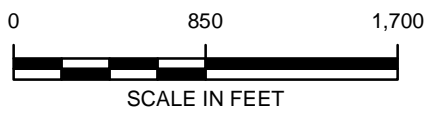

NOTES:

1. TOPOGRAPHY FROM AEP DRAWING 13-30500-11-E. CONTOUR INTERVAL: 10 FEET
2. WELL COORDINATE SOURCE: GAI CONSULTANTS, MARCH 2006. CLASS F INDUSTRIAL FACILITY APPLICATION, JOHN E. AMOS LANDFILL.
3. WEST VIRGINIA 1983 STATE PLANAR COORDINATES.
4. MW-3 AND MW-7 WERE ABANDONED AND REPLACED BY MW-3R AND MW-7R. MW-3R WAS ABANDONED AND REPLACED BY MW-3RA.
5. MONITORING WELL MW-3R, MW-3RA, AND MW-7R LOCATIONS ARE APPROXIMATE.
6. EXTENT OF CONSTRUCTION BASED ON AEP JOHN E. AMOS LANDFILL CELLS 1A, 1B, 2A, 2B, 3A, AND 3B CROSS-SECTIONS.

AEP AMOS GENERATING PLANT - FGD LANDFILL
WINFIELD ROAD
WINFIELD, WEST VIRGINIA

CURRENT MONITORING WELL NETWORK MAP



FIGURE 7

City: CITRIX Div/Group: I/MDV Created By: K.Ives Last Saved By: webb
OH015976.0009.00001 (Mountainair Ash Pond)
Z:\GIS\PROJECTS\ENV\AEP\amos\mxd\Landfill Report\F7_WellNetwork_topo.mxd 3/14/2016 11:57:00 AM

APPENDIX A

Boring/Well Construction Logs and Closure Information





GAI Consultants, Inc. 2006

Boring Logs

**B-0501 to B-0525 & MW-1 to
MW-10**

N 540558.4978
E 1723508.1269 Grade El. 759.08



PROJECT AREA 2/3 JOHN E. AMOS POWER PLANT ST, ALBANS, WV BORING NO. 0501
ELEVATION _____ GWL 0 HRS 8.4 PROJECT NO. C040384.42-01
DATE 18-19 APR 2005 CLASSIFIED BY DAN SANGER PAGE 1 of 3

DEPTH (FT.)	BLOWS PER SIX INCHES OR CORE RECOVERY/RUN	CORE RECOVERY/RUN SAMPLE NO., TYPE & RECOVERY OR % ROCK RECOVERY	RQD (%) OR TORVANE	DESCRIPTION				USCS OR ROCK BROKENNESS	REMARKS*
				PROFILE	SOIL DENSITY - CONSISTENCY OR ROCK HARDNESS	COLOR	MATERIAL CLASSIFICATION		
1	2	3	4	5	6	7	8	9	10
1.5	1	S-1			V. LOOSE	BROWN	SANDY SILT	ml	SLIGHTLY MOIST
3.0	3	REC 0.8			LOOSE	BROWN	SANDY SILT AND SMALL ROCK FRAGS	ml	SLIGHTLY MOIST
4.5	1	S-3			V. STIFF	BROWN	SILTY CLAY	cl	* 2.0 TSF
6.0	3	REC 0.8			V. STIFF	GRAY + BROWN MOTTLED	SANDY CLAY MOIST	cl	* 2.75 TSF
7.5	5	S-5			V. STIFF	GRAY + BROWN MOTTLED	SANDY CLAY MOIST	cl	* 3.0 TSF
9.0	4	REC 1.5			V. STIFF	GRAY + BROWN MOTTLED	SANDY CLAY MOIST	cl	* 3.0 TSF
10.5	3	S-7			V. STIFF	GRAY + BROWN MOTTLED	SANDY CLAY MOIST	cl	* 3.0 TSF
12.0	8	1.3			V. STIFF	GRAY + BROWN MOTTLED	SANDY CLAY MOIST	cl	* 3.75 TSF
13.5	3	S-9			HARD	GRAY + BROWN MOTTLED	SANDY CLAY : DECOMP. CLAYSTONE	cl	* 4.5 TSF
15.0	4	REC 1.5			HARD	GRAY + BROWN MOTTLED	SANDY CLAY : DECOMP. CLAYSTONE	cl	* 4.5 TSF
16.5	3	S-11			HARD	GRAY + BROWN MOTTLED	SANDY CLAY : DECOMP. CLAYSTONE	cl	* 4.0 TSF
18.0	4	REC 1.5			HARD	GRAY	SANDY CLAY : DECOMP. CLAYSTONE	cl	* 4.25 TSF
19.5	2	S-13			HARD	GRAY	SANDY CLAY : DECOMP. CLAYSTONE	cl	* 4.5 TSF
21.0	3	REC 1.5			HARD	GRAY BLUE BROWN MOTTLED	SANDY CLAY : DECOMP. CLAYSTONE	cl	* 4.5 TSF
22.3	16	S-15		22.3	SOFT	GRAY	DECOMPOSED SANDY CLAYSTONE		
				22.3	V. SOFT TO SOFT	GRAY + BROWN MOTTLED	HIGHLY WEATHERED CLAYSTONE	UBR-BR	30° SLICEN, IDED FRAC- TUNES AT 23.5, 23.75, 24.9 LOW ANGLE FRACTURES AT 22.7, 23.0, 23.6, 23.9, 24.05, 24.2, 24.5, 24.6, 25.2, 26.0, 26.3, 27.7, 28.0, 28.4, 29.6, 30.3
	9.2	9.2	100%	71	27.4	SOFT	GRAY	SANDY CLAYSTONE	BR-BL
				25.0	SOFT TO	GRAY	INTERBEDDED SANDY SILTSTONE AND SANDSTONE	BL	45° FRACTURE 27.25 - 27.4

REMARKS ** DRILLED BY [unclear] WITH [unclear] HODD-T2 MARK B, 2.11
BORING ADVANCED WITH 5/4" SOLID STEM AUGERS, 4" Ø CASING, MQ-2 WIRELINE CORING TOOLS

PROJECT AREA 2/3 AMOS POWER PLANT ST. ALBANS, WV BORING NO. B-0501
 ELEVATION _____ GWL 0 HRS 8.4 PROJECT NO. C040384/40-01
 DATE 18-19 APR 2005 CLASSIFIED BY DAN SANGER PAGE 2 of 3

DEPTH (FT.)	BLOWS PER SIX INCHES OR CORE RECOVERY/RUN	CORE RECOVERY/TYPE & SAMPLE NO., TYPE & RECOVERY OR % ROCK RECOVERY	RQD (%) OR TORVANE	DESCRIPTION				USCS OR ROCK BROKENNESS	REMARKS*
				PROFILE	SOIL DENSITY - CONSISTENCY OR ROCK HARDNESS	COLOR	MATERIAL CLASSIFICATION		
1	2	3	4	5	6	7	8	9	10
31.5	◆				M. SOFT	GRAY	INTER-BEDDED SANDY SILTSTONE AND SANDSTONE (CONT)	BL	
									LOW ANGLE FRACTURES
									33.6, 34.4, 36.0, 36.2, 36.7, 37.35, 37.8, 38.0, 38.2
				34.6	SOFT	GRAY + MARLON MOTTLED	CLAYSTONE	VBR-	41.1
	10.0	10.0	100%	70				BR	30° FRACTURES W/ SLICKEN-SIDES 35.4, 39.25, 39.75, 40.0, 41.3-41.5
									BROKEN ZONES 35.6-35.8, 40.0-41.0, 41.5-42.3
41.5	◆								
				42.3	M. SOFT TO M. HARD	GRAY	SANDSTONE	BL	LOW ANGLE FRACTURES
									42.3, 43.25, 48.0, 48.1, 48.5, 50.2, 51.5, 51.7
	9.3	10.0	93%	88					52.2, 52.7, 53.4
				48.0					
				48.5	SOFT	DK GRAY	SANDY CLAYSTONE	BR	
					M. SOFT TO M. HARD	GRAY	INTERBEDDED SANDSTONE AND SANDY SILTSTONE	BL	
51.5	◆								
				53.4	SOFT	GRAY + MARLON MOTTLED	SANDY TO SILTY CLAYSTONE	VBR- BR	LOW ANGLE FRACTURES
									53.7, 54.05, 54.3, 54.85, 55.4, 55.55, 55.7, 55.85, 56.05, 56.5, 56.7, 56.9, 57.2, 58.0, 58.5, 58.9, 59.4, 60.6, 60.85, 61.35
	9.3	10.0	93%	31					BROKEN ZONE 59.3-60.6

REMARKS ** _____ ~30° SLICKENSIDED FRACTS. 54.4, 57.55, 57.9, 58.25, 58.75, 61.1

PROJECT AREA 2-1/3 AMOS POWER PLANT ST ALBANS, WV

BORING NO. B0501

ELEVATION _____ GWL 0 HRS 8.4

PROJECT NO. C040384.40.01

DATE 18-19 APR 2005 CLASSIFIED BY DAN SANGER

PAGE 3 of 3

DEPTH (FT.)	BLOWS PER SIX INCHES OR CORE RECOVERY/RUN	CORE RECOVERY/TYPE & SAMPLE NO., TYPE & RECOVERY OR % ROCK RECOVERY	RQD (%) OR TORVANE	DESCRIPTION				USCS OR ROCK BROKENNESS	REMARKS*
				PROFILE	SOIL DENSITY - CONSISTENCY OR ROCK HARDNESS	COLOR	MATERIAL CLASSIFICATION		
1	2	3	4	5	6	7	8	9	10
61.5	◆			61.6					
					SFFT	MARBLE W/ GRAY YELLOW, AND PURPLE MOTTLING	CLAYSTONE HIGHLY WEATHERED - CORE IS HIGHLY PITTED	VBL- BR	61.5-65.9 APPARENT ZONE OF CORE LOSS BROKEN ZONE: 69.5-66.7 LOW ANGLE FRACTURES 66.9, 67.15, 67.3, 67.75, 67.85, 68.9, 69.1, 69.65, 70.6
	5.6	60	56%	28%					
71.5	◆								
	7.6	85	89%	27					30° SLICKENSIDED FRACTURE 69.9, 71.1, 71.4, 74.2, 75.0 BROKEN ZONE 71.5-72.3 APPARENT CORE LOSS 72.3- 73.2
80.0	▲			80.0					LOW ANGLE FRACTURES 74.55, 74.7, 75.35, 75.55, 75.8, 76.1, 76.75, 77.5, 77.65, 77.85, 78.2, 78.5, 78.65, 78.75, 78.85, 79.0, 79.2, 79.5, 79.8, 79.9
							BOTTOM OF BORING : 80.0'		

REMARKS **

* POCKET PENETROMETER READINGS
** METHOD OF ADVANCING AND CLEANING BORING

BORING NO. B0501

(8-3)

N 540563.2422
 E 1723508.0316 Grade El. 759.46



PROJECT AREA 2/3 JOHN E. AMOS POWER PLANT ST. ALGONS, WI BORING NO. B-0502
 ELEVATION 758± GWL 0 HRS _____ PROJECT NO. CD40384.40-01
 DATE 21 APR 2005 HRS _____ CLASSIFIED BY NAN SANGER PAGE 1 of 1

DEPTH (FT.)	BLOWS PER SIX INCHES OR CORE RECOVERY/RUN	CORE RECOVERY/RUN SAMPLE NO., TYPE & RECOVERY OR % ROCK RECOVERY	RQD (%) OR TORVANE	DESCRIPTION				USCS OR ROCK BROKENNESS	REMARKS*
				PROFILE	SOIL DENSITY - CONSISTENCY OR ROCK HARDNESS	COLOR	MATERIAL CLASSIFICATION		
1	2	3	4	5	6	7	8	9	10
							AUGER W/O SAMPLING TO 22'		
							SET PIEZOMETER - TIP AT 21'		
							↑		
							↓		
				22.0			BOTTOM OF BORING: 22'		

REMARKS ** DRILLED BY TERESA TESTING INC. USING A SIMCO 4000 TB TRACK MOUNTED DRILL BORING ADVANCED USING 5/4" SOLID STEM AUGERS

* POCKET PENETROMETER READINGS
 ** METHOD OF ADVANCING AND CLEANING BORING

BORING NO. B-0502
 (34)

N 540843.8055
E 1723858.5630 Grade El. 775.00



PROJECT AREA 2/3 JOHN E. AMOS POWER PLANT, ST. ALBANS, WV BORING NO. 0503
ELEVATION _____ GWL 0 HRS 11.4 PROJECT NO. C04084.40-01
DATE 18-19 APR 2005 CLASSIFIED BY DAN SANGER PAGE 1 of 2

DEPTH (FT.)	BLOWS PER SIX INCHES OR CORE RECOVERY/RUN	SAMPLE NO., TYPE & RECOVERY OR % ROCK RECOVERY	ROD (%) OR TORVANE	PROFILE	DESCRIPTION			USCS OR ROCK BROKENNESS	REMARKS*
					SOIL DENSITY - CONSISTENCY OR ROCK HARDNESS	COLOR	MATERIAL CLASSIFICATION		
1	2	3	4	5	6	7	8	9	10
1.5	1 W.O.H	S-1			V. LOOSE	BROWN	CLAYEY SILT	MI	MOIST
3.0	1 W.O.H	REC. 1.0 S-2			V. LOOSE	BROWN	CLAYEY SILT, TRACE SAND	MI	MOIST
4.5	1	REC. 1.1 S-3			V. SOFT	BROWN	SILTY CLAY	CI	WET, * 0.5
6.0	2	REC. 0.1 S-4			HARD	GRAY + BROWN MOTTLED	SANDY CLAY	CI	SLIGHTLY MOIST, * 4.5
7.5	3	REC. 1.4 S-5			M. DENSE	BROWN	SANDY SILT	MI	SLIGHTLY MOIST
9.0	3	REC. 0.4 S-6			HARD	GRAY + BROWN MOTTLED	SANDY CLAY: DECOMP. CLAYSTONE	CI	SLIGHTLY MOIST, * 4.5 TSF
10.5	3	REC. 1.2 S-7			STIFF		SANDY CLAY	CI	MOIST * 3.75 TSF
12.0	6	REC. 0.4 S-8			HARD	GRAY + BROWN MOTTLED	SANDY CLAY	CI	SLIGHTLY MOIST, * 4.5 TSF
13.5	3	REC. 1.2 S-9			HARD	GRAY + BROWN MOTTLED	SANDY CLAY	CI	SLIGHTLY MOIST * 4.5 TSF
15.0	3	REC. 1.3 S-10			HARD	GRAY	SANDY CLAY	CI	SLIGHTLY MOIST, * 4.5 TSF
16.5	3	REC. 1.0 S-11			HARD	GRAY	SANDY CLAY	CI	SLIGHTLY MOIST 4.5 TSF
18.0	1	REC. 1.3 S-12			V. STIFF	GRAY	SANDY CLAY, SOME SILT	CI	MOIST, * 3.75 TSF
19.5	1	REC. 1.4 S-13			V. STIFF	DARK GRAY CLAY	SANDY CLAY, TRACE ORGANICS	CI	SLIGHTLY MOIST, * 3.75 TSF
21.0	6	REC. 1.3 S-14			V. STIFF	DARK GRAY CLAY	SANDY CLAY, TRACE ORGANICS	CI	SLIGHTLY MOIST, * 3.5 TSF
22.5	2	REC. 1.2 S-15			LOOSE	BLUE + GRAY	CLAYEY SAND, TRACE ROCK FRAGMENTS	SC	MOIST
23.4	2	REC. 1.3 S-16			SOFT	BLUE-GRAY	DECOMPOSED CLAYSTONE FRAGMENTS		
	50/0.4	REC. 0.9		23.4	SOFT	GRAY	DECOMPOSED CLAYSTONE	VBR	TOP OF ROCK 23.4
				24.0	M. SOFT	GRAY	SILTY SANDSTONE	VBA-	CLAY SEAM 24.7, 29.?
					M. HARD			BA	VERTICAL FRACTURES 23.4-24.4
									25.25-25.3, 27.45-27.55
	7.5	7.5	100%	35					LOW ANGLE FRACTURES: 23.6
									23.8, 24.05, 24.15, 24.3,
									24.4, 24.55, 24.9, 25.05, 25.15

REMARKS ** DRILLED BY TERRA TESTING USING A SIMCO 4000 FT TRACK MOUNTED DRILL RIG. BORAING ADVANCED USING 5/4" SOLID STEM AUGERS, NQ CASING, NQ-2 WIRELINE CASING TOOLS

* POCKET PENETROMETER READINGS
** METHOD OF ADVANCING AND CLEANING BORING

BORING NO. 0503

(B-S)

N 541325.3505
E 1723551.3362 Grade El. 910.89

PROJECT AREA 7/3 JOHN E. AMOS POWER PLANT ST. ALBANS, WV

BORING NO. B0505

ELEVATION _____ GWL 0 HRS 84.0

PROJECT NO. C046384.40.01

DATE 20 25 APR 2005

CLASSIFIED BY DAN SANGER

PAGE 1 of 7

DEPTH (FT.)	BLOWS PER SIX INCHES OR CORE RECOVERY/RUN	CORE RECOVERY/RUN SAMPLE NO., TYPE & RECOVERY OR % ROCK RECOVERY	ROD (%) OR TORVANE	DESCRIPTION				USCS OR ROCK BROKENNESS	REMARKS*
				PROFILE	SOIL DENSITY - CONSISTENCY OR ROCK HARDNESS	COLOR	MATERIAL CLASSIFICATION		
1	2	3	4	5	6	7	8	9	10
1.5	3	S-1 REC. 0.1			LOOSE	TAN	SANDY SILT, SLIGHTLY MOIST	ML	
3.2	12	30 REC. 1.5			DENSE				DECOMPOSED SANDSTONE/ SANDY SHALE
3.8	12	50/0.3 3-3 REC. 0.8		3.8	U. DENSE				
				6.2	SOFT	TAN	SANDSTONE: HIGHLY WEATHERED	BR-VBR	TOP OF ROCK: 3.8'
				6.2	V. SOFT	TAN	SANDSTONE: COMPLETELY WEATHERED	VBR	
	7.2	7.2	100%	6.2	M. SOFT TO HARD	TAN	SANDSTONE: MODERATELY WEATHERED, MICACEOUS, FINE TO MEDIUM GRAINED	BR-BL	VERTICAL FRACTURE 6.2-6.5 LOW & FRACTURES: 6.7, 7.25, 8.4, 9.8, 11.2, 11.45, 11.6
				11.6	V. SOFT	TAN	SANDSTONE: COMPLETELY WEATHERED, MICACEOUS, FINE TO MEDIUM GRAINED	VBR	
				14.0	SOFT	TAN	SANDSTONE: HIGHLY WEATHERED, MICACEOUS, FINE TO MEDIUM GRAINED	BR	LOW & FRACTURES: 14.0, 14.2, 14.3, 14.35, 14.45, 14.55, 15.75, 16.5, 17.0
	10.0	10.0	100%	36	V. SOFT TO SOFT	TAN	SANDSTONE: COMPLETELY WEATHERED, MICACEOUS, FINE TO MEDIUM GRAINED	VBR	
				18.5	SOFT	TAN	SANDSTONE: HIGHLY WEATHERED, MICACEOUS, FINE TO MEDIUM GRAINED	BR	LOW & FRACTURES: 21.1, 22.3, 22.45, 22.55, 22.7, 23.0, 23.1, 23.5, 23.75, 24.05, 24.55
21.0				21.0	SOFT	TAN	SANDSTONE: HIGHLY WEATHERED, MICACEOUS, FINE TO MEDIUM GRAINED	BR	LOW & FRACTURES: 21.1, 22.3, 22.45, 22.55, 22.7, 23.0, 23.1, 23.5, 23.75, 24.05, 24.55
	8.7	10.0	87%	55					STAINED 30° FRACTURE 21.9

REMARKS ** DRILLED BY TERRA TERRIN, INC. USING A SIMCO 4000-T2 TRACK MOUNTED DRILL BORING ADVANCED USING 5/4" SOLID STEM AUGERS, CONTINUOUS SPT, M3-2 WIRELINE CORING TOOLS

* POCKET PENETROMETER READINGS
** METHOD OF ADVANCING AND CLEANING BORING

BORING NO. B0505

PROJECT AREA 2/3 JOHN E. AMOS POWER PLANT, ST. ALBANS, WV

BORING NO. B-0505 (27)

ELEVATION _____ GWL 0 HRS 84.0

PROJECT NO. C040384.40-01

DATE 20 APR 2005 CLASSIFIED BY DAN SANGER

PAGE 2 of 7

DEPTH (FT.)	BLOWS PER SIX INCHES OR CORE RECOVERY/RUN SAMPLE NO., TYPE & RECOVERY OR % ROCK RECOVERY	RQD (%) OR TORVANE	DESCRIPTION					USCS OR ROCK BROKENNESS	REMARKS*
			PROFILE	SOIL DENSITY - CONSISTENCY OR ROCK HARDNESS	COLOR	MATERIAL CLASSIFICATION			
1	2	3	4	5	6	7	8	9	10
31.0	◆			31.0	↓	↓	↓	↓	
				32.0	U. SOFT	TAN	SANDSTONE: COMPLETELY WEATHERED	UBR	
					M. HARD	BROWN	SANDSTONE: MODERATELY WEATHERED	BR-BL	
							MICACEOUS, MEDIUM GRAINED		
									70° HIGHLY STAINED
	100	10.0	100%	41					FRACTURE 34.6-35.1
				36.5	SOFT TO M. SOFT	BLUE-GRAY	SHALE	BR	VERTICAL FRACTURE 35.7-36.6
									LOW % FRACTURES: 35.1,
									35.3, 35.45
				39.2					
				40.0	M. SOFT	TAN	SILTSTONE	UBR	STAINED VERT. FRAC. 39.2-40.0
41.0	◆			41.3	M. HARD	DK GRAY	SILTY SANDSTONE	BR	HIGH % STAINED FRACS:
					M. HARD	OLIVE	SANDSTONE: V. FINE GRAINED		42.0-40.3, 40.55-40.7
									LOW % STAINED FRAC 41.8
				43.7					NEAR VERTICAL STAINED
					M. SOFT TO SOFT	BLUE-GRAY	SILTY SHALE	VBR	FRACTURE 41.8-42.2
	10.0	10.0	100%	44					HIGH % STAINED FRACTURE
									45.6-46.1
				47.0	M. SOFT	OLIVE-GRAY	SANDSTONE: FINE GRAINED, SOME CROSS BEDDING	BR	HIGH % STAINED FRACTURE
									49.5-49.9, 52.1-52.9,
									54.15-54.3, 55.7-55.9
51.0	◆								VERTICAL STAINED FRACTURE 51.5-52.2,
				55.4					
	10.0	10.0	100%	36	SOFT	GRAY	SANDY SHALE	VBR-	
									VERTICAL STAINED FRACS
									55.1-56.7,
									HIGH % + VERTICAL STAINED
									FRACTURES 57.2-59.6

REMARKS **

* POCKET PENETROMETER READINGS

** METHOD OF ADVANCING AND CLEANING BORING

BORING NO. B-0505

(27)

PROJECT AREA 273 JOHN E. AMOS POWER PLANT ST ALBANY, NY BORING NO. B-0505
 ELEVATION _____ GWL 0 HRS 84.0 PROJECT NO. C040384.40-0
 DATE 20 25 APR 2005 CLASSIFIED BY DAN SANGER PAGE 3 of 7

DEPTH (FT.)	BLOWS PER SIX INCHES OR CORE RECOVERY/RUN	SAMPLE NO., TYPE & RECOVERY OR % ROCK RECOVERY	RQD (%) OR TORVANE	DESCRIPTION				USCS OR ROCK BROKENNESS	REMARKS*
				PROFILE	SOIL DENSITY - CONSISTENCY OR ROCK HARDNESS	COLOR	MATERIAL CLASSIFICATION		
1	2	3	4	5	6	7	8	9	10
61.0	◆			61.2	SOFT TO M-SOFT	GRAY	CLAY SHALE	BR- BL	30'S STAINED FRAC. 60.3' HIGH & STAINED FRAC-TURE AT 62'
				65.5		MARBLE MOTTLED			
	10.0	10.0	100%	52	M-HARD	GRAY	SANDSTONE	BSL	
				66.9	SOFT	GRAY + MARBLE	CLAY SHALE	BR	HIGH STAINED FRAC. 66.5-66.7
				68.8	M-HARD	LT GRAY	SANDSTONE		HIGH FRACTURE 67.7-67.9
							SHALY 67.7-68.8		VERTICAL FRACTURE 68.2-68.6
71.0	◆				V-SOFT	BROWN GRAY	CLAYSTONE - COMPLETELY WEATHERED	VB- BR	
				73.0	SOFT TO M-SOFT	DK GRAY TO CLAY	CLAYSTONE	BR	SLICKESIDES 73.55, 74.7, 74.8, 75.6, 75.9, 76.5, 77.0, 77.35
	10.0	10.0	100%	40					
				78.0	M-HARD	BROWN + GRAY	SANDSTONE: FINE TO MEDIUM GRAINED	BR	VERTICAL STAINED FRACTURE 77.7-80.5
81.0	◆							BL	
						BROWN			
	10.0	10.0	100%	76					
								BR	VERTICAL STAINED FRACTURE 87.5-88.8

REMARKS ** _____

* POCKET PENETROMETER READINGS
 ** METHOD OF ADVANCING AND CLEANING BORING

PROJECT AREA 2/3 JOHN E. AMOS POWER PLANT ST. ALBANS, WV BORING NO. B-0505
 ELEVATION _____ GWL 0 HRS 84.0 PROJECT NO. C04038440-01
 DATE 20-25 APR 2005 CLASSIFIED BY DAN SANGER PAGE 4 of 7

DEPTH (FT.)	BLOWS PER SIX INCHES OR CORE RECOVERY/RUN	CORE RECOVERY/RUN SAMPLE NO., TYPE & RECOVERY OR % ROCK RECOVERY	RQD (%) OR TORVANE	DESCRIPTION				USCS OR ROCK BROKENNESS	REMARKS*
				PROFILE	SOIL DENSITY - CONSISTENCY OR ROCK HARDNESS	COLOR	MATERIAL CLASSIFICATION		
1	2	3	4	5	6	7	8	9	10
91.0	◆				M. HARD	BROWN	SANDSTONE (CONT)	B2-	
								BL	LOW & FRACTURES 93.8, 94.2, 95.1, 95.2, 95.6,
	10.0	10.0	100%	86		GRAY			
101.0	◆			101.5	SOFT	GRAY	SILTY SHALE	UBR	MUCH OF CORE IS PIECES 0.1-0.2'
							: BECOMES SANDY AT 104.75		LOW & FRACTURES 101.4, 102.0, 102.5, 102.9, 103.4, 104.3, 104.5, 104.75
	10.0	10.0	100%	108.7					VERTICAL FRACTURE 106.7-107.7
111.0	◆			112.2	M. HARD	GRAY	SANDSTONE: FINE GRAINED		UNBROKEN ZONE 107.0-107.7 STAINED NEAR VERTICAL FRACTURE 107.1-108.7
					SOFT TO M. SOFT	DK GRAY MAROON	CLAYSTONE	VBR	45° SLICKENSIDE 112.9-113.0
									UNBROKEN ZONE 114.2-114.8
	9.2	10.0	92%		M. SOFT	GRAY			LOW & FRACTURE 117.8, 119.6, 120.4
					SOFT	GRAY MAROON			

REMARKS ** _____

* POCKET PENETROMETER READINGS
 ** METHOD OF ADVANCING AND CLEANING BORING

PROJECT AREA 2/3 JOHN E. AMOS POWER PLANT ST. ALBANS, WV BORING NO. B-0505
 ELEVATION _____ GWL 0 HRS 84.0 PROJECT NO. C040384.40-1
 DATE 20-25 APR 2005 CLASSIFIED BY DAN SANDER PAGE 5 of 7

DEPTH (FT.)	BLOWS PER SIX INCHES OR CORE RECOVERY/RUN	CORE RECOVERY/TYPE & SAMPLE NO., TYPE & RECOVERY OR % ROCK RECOVERY	RQD (%) OR TORVANE	PROFILE	DESCRIPTION			USCS OR ROCK BROKENNESS	REMARKS*
					SOIL DENSITY - CONSISTENCY OR ROCK HARDNESS	COLOR	MATERIAL CLASSIFICATION		
1	2	3	4	5	6	7	8	9	10
121.0	◆				SOFT	GRAY + MAROON	CLAYSTONE (CONT) MODERATELY TO HIGHLY WEATHERED	VBR- BR	1.3M & FRACTURES 121.4, 121.7, 122.3, 122.6, 122.9, 123.1, 123.4, 123.8, 124.1
		6.0	10.0	60%	U. SOFT TO SOFT		: HIGHLY WEATHERED	VBR	124.8-132.0 HIGHLY WEATHERED ZONE
131.0	◆					GREEN-GRAY MAROON		BR	45° SLICKENSIDES 133.3, 134.2, 134.9, 136.9, 139.2-139.4
		9.2	10.0	92%	M. SOFT	GRAY WITH MAROON CLASTS + STAININGS	SANDY CLAYSTONE	BR- BL	SLICKENSIDES AT 142.35, 143.9, 144.7, 145.1, 145.35, 146.25, 148.3, 148.9, 150.4, 150.65
141.0	◆							VBR- BR	
		10.0	10.0	100%	SOFT	MAROON	: BECOMES SILTY AT 144.6	BR	

REMARKS ** _____

* POCKET PENETROMETER READINGS
 ** METHOD OF ADVANCING AND CLEANING BORING

PROJECT AREA 2/3 JOHN E. AMOS POWER PLANT ST. ALBANS, WV BORING NO. B-0505
 ELEVATION _____ GWL 0 HRS 94.0 PROJECT NO. C040384.40-01
 DATE 20-25 APR 2005 CLASSIFIED BY DAN SANGER PAGE 6 of 7

DEPTH (FT.)	BLOWS PER SIX INCHES OR CORE RECOVERY/RUN	CORE RECOVERY/RUN SAMPLE NO., TYPE & RECOVERY OR % ROCK RECOVERY	RQD (%) OR TORVANE	PROFILE	DESCRIPTION			USCS OR ROCK BROKENNESS	REMARKS*
					SOIL DENSITY - CONSISTENCY OR ROCK HARDNESS	COLOR	MATERIAL CLASSIFICATION		
1	2	3	4	5	6	7	8	9	10
151.0	◆			151.5	M. HARD	GREEN-GRAY	SANDSTONE	BR	
				153.2	M. SOFT	GRAY	SANDY SHALE	BR	LOW 45° FRACTURE 153.4, 153.65
	10.0	10.0	100%	86	156.1				45° FRACTURE 154.35 - 154.5
				157.5	M. HARD	GRAY	SHALY SANDSTONE	BR-BL	LOW 45° FRACTURE 157.35
161.0	◆								
	10.0	10.0	100%	84					
				168.5	M. SOFT TO SOFT	GRAY TO DR. GRAY	CLAYSTONE	UBA-BR	CLAYSEAM 167.55-167.70 LOW 45° FRACTURES 168.75, 168.85, 169.15, 169.20, 170.7, 171.2, 171.6, 174.8, 174.95
171.0	◆			173.4	M. SOFT TO M. HARD	GRAY + MAROON	SANDY CLAYSTONE	BL	45° FRACTURE 169.75 - 170.1, 172.35, 172.7 LOW 45° SLICKENSIDES 170.4, 172.7, 171.85, 172.9, 173.1, 173.4
	9.3	10.0	93%	6.1					
				179.0	M. SOFT	MAROON	CLAYSTONE	PA-VBR	45° SLICKENSIDES 179.2, 179.4, 179.7, 179.9 - 180.0

REMARKS **

* POCKET PENETROMETER READINGS
 ** METHOD OF ADVANCING AND CLEANING BORING

PROJECT AREA 2/3 JOHN E. AMOS POWER PLANT ST. ALBANS, WV BORING NO. B-0505
 ELEVATION _____ GWL 0 HRS 84.0 PROJECT NO. CO40384.40-01
 DATE 20-25 APR 2005 CLASSIFIED BY DAN SANGER PAGE 7 of 7

DEPTH (FT.)	BLOWS PER SIX INCHES OR CORE RECOVERY/RUN SAMPLE NO., TYPE & RECOVERY OR % ROCK RECOVERY	RQD (%) OR TORVANE	DESCRIPTION				USCS OR ROCK BROKENNESS	REMARKS*	
			PROFILE	SOIL DENSITY - CONSISTENCY OR ROCK HARDNESS	COLOR	MATERIAL CLASSIFICATION			
1	2	3	4	5	6	7	8	9	10
181.0	◆				M. SOFT	MAROON	CLAYSTONE		LOW & SLICKEN SIDES 181.9, 182.2, 183.2, 183.6, 184.0, 184.15, 184.4
				185.0	↓	↓	↓	VBR	V. BROKEN 184.4-185.0
	10.0 10.0	100%	67		M. HARD	GRAY	SANDSTONE	BL	
				190.0	↓	↓	↓		CLAY SEAM 188.7
191.0	◆			191.0	M. SOFT	MAROON	CLAYSTONE	BR	
					M. HARD	GRAY	SANDSTONE	BL	
	9.0 9.0	100%	88		↓	↓	↓		
				198.1	↓	↓	↓		
					M. SOFT	GRAY	SANDY CLAYSTONE	VBA-	SLICKEN SIDES 198.45, 198.9,
200.0	▲				↓	MAROON	↓	BR	199.25, 199.35, 199.6, 199.8
							BOTTOM OF BORING: 200.0'		

REMARKS ** _____

* POCKET PENETROMETER READINGS
 ** METHOD OF ADVANCING AND CLEANING BORING

N 539424.9688
E 1722518.6810 Grade El. 709.52



PROJECT AREA #3 JOHN E. AMOS POWER PLANT ST. ALBANS, VT BORING NO. B-0506
ELEVATION _____ GWL 0 HRS 21.3 PROJECT NO. C040384.45.0
DATE 21 APR 2005 CLASSIFIED BY DAN JAMER PAGE 1 of 3

DEPTH (FT.)	BLOWS PER SIX INCHES OR CORE RECOVERY/RUN	CORE RECOVERY/RUN SAMPLE NO., TYPE & RECOVERY OR % ROCK RECOVERY	RQD (%) OR TORVANE	DESCRIPTION				USCS OR ROCK BROKENNESS	REMARKS*
				PROFILE	SOIL DENSITY - CONSISTENCY OR ROCK HARDNESS	COLOR	MATERIAL CLASSIFICATION		
1	2	3	4	5	6	7	8	9	10
1.5	1 2 4	S-1 REC 0.6 S-2			LOOSE	BROWN	SANDY SILT SOME ORGANICS	ml	FILL
3.0	4 5 6	REC 0.9			M-DENSE	RED BROWN	SANDY SILT MOIST	ml	
4.5	3 5 6	S-3 REC 1.5 S-4			M-DENSE	RED BROWN	CLAYEY SILT / SILTY CLAY w/ R.F.	ml/cl	
6.0	8 3 3	REC 1.5			M-DENSE	RED BROWN	CLAYEY SILT AND ROCK FRAGMENTS	ml	MOIST
7.5	4 5 6	S-5 REC 0.2 S-6			M-DENSE	RED BROWN	CLAYEY SILT AND ROCK FRAGMENTS	ml	MOIST
9.0	10 11	REC 0.6			M-DENSE	RED BROWN	CLAYEY SILT AND ROCK FRAGMENTS (DECOMPOSED CLAYSTONE)	ml	MOIST
10.5	7 12	S-7 REC 1.5 S-8							
12.0	16 18	REC 1.0			DENSE	RED BROWN	CLAYEY SILT AND ROCK FRAGMENTS (DECOMPOSED CLAYSTONE)	ml	SLIGHTLY MOIST
13.5	8 11	S-9 REC 1.5 S-10			DENSE	RED BROWN	DECOMPOSED CLAYSTONE		DRY
15.0	22 24 30	REC 1.2			V-DENSE	YELLOW CLAY	DECOMPOSED CLAYSTONE		DRY
16.5	18 25	S-11 REC 1.5 S-12			V-DENSE		DECOMPOSED CLAYSTONE		DRY
18.0	12 19 20 21 22 23 24 25 26 27 28 29 30	REC 1.5		18.0	HAND		DECOMPOSED CLAYSTONE		DRY
				19.2	SOFT TO M-SFT	MARON	CLAYSTONE	BL	LOW # FRACTURES
22.0	4.0	100%	90						19.65, 20.05, 21.6
							: SANDY 24.7-25.4		BROKEN ZONE: 22.0-22.5
							: SANDY 27.4-29.4		45° SLICKENSIDE w/ SLICKENSIDE 22.75-22.95
	9.6	10.0	96%	86					LOW # FRACTURES
									24.6, 45° SLICKENSIDE 28.3-28.55

REMARKS ** DRILLED BY TERRA TESTING, INC. USING A SIMCO 4000 T2 TRACK MOUNTED DRILL.
BORING ADVANCED USING 5/8" SOLID STEM AUGERS, 4" I.D. STEEL CASING, CONTINUOUS SPT, NQ-2 WIRELINE CORING TOOLS
* POCKET PENETROMETER READINGS BORING NO. B-0506
** METHOD OF ADVANCING AND CLEANING BORING

PROJECT AREA 2/3 JOHN B. AMOS POWER PLANT ST. ALBANS, WV BORING NO. B-0506
 ELEVATION _____ GWL 0 HRS 21.3 PROJECT NO. C040384.40-01
 DATE 22-2 APR 2005 CLASSIFIED BY DAN SANGER PAGE 2 of 3

DEPTH (FT.)	BLOWS PER SIX INCHES OR CORE RECOVERY/RUN	CORE RECOVERY/TYPE & RECOVERY OR % ROCK RECOVERY	RQD (%) OR TORVANE	DESCRIPTION				USCS OR ROCK BROKENNESS	REMARKS*
				PROFILE	SOIL DENSITY - CONSISTENCY OR ROCK HARDNESS	COLOR	MATERIAL CLASSIFICATION		
1	2	3	4	5	6	7	8	9	10
32.0	◆				SOFT TO M. SFT	MARON	CLAYSTONE (CONT) : CORE SURFACE WEATHERED		LOW % FRACTURES w/ SLICKENSIDES: 32.65 33.0, 33.25, 33.75, 34.05, 35.55, 36.65, 38.4 45° FRACTURES w/ SLICKENSIDES: 36.9 37.25-37.45, 38.85- 38.95
	9.9	10.0	99%	58			: IRREGULAR CALCAREOUS CLASTS 37.5-38.7	BR	
42.0	◆								LOW % FRACTURES w/ SLICKENSIDES 42.4, 42.65, 42.95, 44.25 45.25, 45.7, 45.9, 47.75, 45° FRACTURES w/ SLICKENSIDES = 48.6, 48.8, 49.0 LOW % FRACTURES w/ SLICKENSIDES: 52.3, 52.4 53.5, 54.2 45° FRACTURES w/SLICK. ENDSIDES 53.55-53.75 54.45-54.6
	10.0	10.0	100%	76					
52.0	◆				S1.0 S1.7	M. SFT GRAY	SANDY CLAYSTONE		
						MARON	CLAYSTONE	BR	
					S4.9	HARD GRAY	SANDSTONE 54.6-54.9	BR	
	10.0	10.0	100%	73	S6.5		SANDY CLAYSTONE	BL	
						M. SFT MARON	CLAYSTONE		

REMARKS ** _____

PROJECT AREA 2/3 JOHN E. AMOS POWER PLANT ST. ALBANS, WV

BORING NO. B-0506

ELEVATION _____ GWL 0 HRS 2/3

PROJECT NO. C040384.40-01

DATE 22-27 APR 2005

CLASSIFIED BY DAN SANGER

PAGE 3 of 3

DEPTH (FT.)	BLOWS PER SIX INCHES OR CORE RECOVERY/RUN	CORE RECOVERY/RUN SAMPLE NO., TYPE & RECOVERY OR % ROCK RECOVERY	RQD (%) OR TORVANE	DESCRIPTION				USCS OR ROCK BROKENNESS	REMARKS*
				PROFILE	SOIL DENSITY - CONSISTENCY OR ROCK HARDNESS	COLOR	MATERIAL CLASSIFICATION		
1	2	3	4	5	6	7	8	9	10
				62.4	M. HARD	GRAY	SHALY SILTSTONE	BL	
62.0	◆				↓	↓	↓		
				64.1	M. HARD	LT GRAY	SANDSTONE		
					↓	↓	↓		
	10.0	10.0	100%	76	HARD				VERTICAL FRACTURE 64.7-65.7 65° FRACTURE 65.9-66.2
				71.5	M. SOFT	GRAY	SILTY SHALE	BE	
72.0	◆				↓	↓	↓		
				72.7	SOFT TO M. SOFT	GRAY	CLAYSTONE	BR-BL	LOW FRACTURE 72.6
					↓	↓	↓		
	8.0	8.0	100%	78					30° FRACTURE W/SUCKEN-SIDE 74.3
				80.0					
80.0	▲								BOTTOM OF BORING: 80.0'

REMARKS **

* POCKET PENETROMETER READINGS
** METHOD OF ADVANCING AND CLEANING BORING

N 539428.8146
 E 1722523.7682 Grade El. 709.99



PROJECT AREA 2/3 JOHN E. AMOS POWER PLANT ST. ALBANY W/ BORING NO. B-0507
 ELEVATION _____ GWL 0 HRS DRY PROJECT NO. C-140324.111
 DATE 26 APR 2005 HRS _____ CLASSIFIED BY DAN SANGER PAGE 1 of 1

DEPTH (FT.)	BLOWS PER SIX INCHES OR	CORE RECOVERY/RUN	SAMPLE NO., TYPE & RECOVERY OR	% ROCK RECOVERY	RQD (%) OR TORVANE	DESCRIPTION				USCS OR ROCK BROKENNESS	REMARKS*
						PROFILE	SOIL DENSITY - CONSISTENCY OR ROCK HARDNESS	COLOR	MATERIAL CLASSIFICATION		
1	2	3	4	5	6	7	8	9	10		
							AUGER W/O SAMPLING TO 18 FT.				
							PIEZOMETRIC INSTALLED, TIP AT 17 FT				
18.0					18.0						

REMARKS** DRILLED BY TERRA TESTING USING A SIMCO 4000-72 TRACK MOUNTED DRILL
BORING ADVANCED USING 5/8" SOLID STEEL AUGERS

PROJECT AREA 2/3 JOHN E. AMOS POWER PLANT ST. ALBANS, WV BORING NO. B-0508
 ELEVATION 982± GWL 0 HRS 87.3 PROJECT NO. C040384.40-01
 DATE 27-28 APR 2005 HRS _____ CLASSIFIED BY DAN SANGER PAGE 1 of 7

DEPTH (FT.)	BLOWS PER SIX INCHES OR CORE RECOVERY/RUN	CORE RECOVERY/RUN SAMPLE NO., TYPE & RECOVERY OR % ROCK RECOVERY	ROD (%) OR TORVANE	DESCRIPTION				USCS OR ROCK BROKENNESS	REMARKS*
				PROFILE	SOIL DENSITY - CONSISTENCY OR ROCK HARDNESS	COLOR	MATERIAL CLASSIFICATION		
1	2	3	4	5	6	7	8	9	10
1.5	14	S-1 REC 1.0		5.2	M. DENSE	TAN	SILT AND DECOMPOSED SHALE FRAGMENTS	M	SLIGHTLY MOIST
3.0	24 50/0.4	S-2 REC 1.2			V. DENSE				
4.5	37 30	S-3 REC 1.3							
5.2	19 50/0.2	S-4 REC 0.7							
5.7	5.7	100%	38	11.5	SOFT	TAN TO BROWN	CLAY SHALE - HIGHLY WEATHERED	BR	LOW & FRACTURES: 5.7, 6.25, 6.75, 6.9 7.4, 7.7, STAINED: 9.2, 9.6 RED STAINED - 65° FRACTURE: 8.4-8.6, 9.0
10.9				12.6	SOFT	TAN	FILTY SHALE	BR	10.4-10.7, 12.0-12.4
				13.7	5 FT	TAN + CLAY	SHALY SANDSTONE - WEATHERED		LOW & FRACTURES 12.9, 13.5
					SOFT	TAN	SHALE - GRADES FROM SILT TO CLAY - WEATHERED		BROKEN 14.1-14.3 VERTICAL FRACTURE 14.8-15.0
	9.7	10.0	97%	50					LOW & FRACTURES 15.6, 15.9
				16.4	SOFT	MAROON	CLAYSTONE	BR-BL	16.3, 16.45, 17.0, 17.3 18.2, 18.65, 20.6 VERTICAL FRACTURE 20.9-21.3 70° FRACTURE WITH SLICKEN SIDES AT 22.2-22.4
20.9									
	10.0	10.0	100%	64				BL	
								BR	

REMARKS** DRIILLED BY TERRA TESTIN INC. USING A SIMCO 4000-T2 TRACK MOUNTED DRILL
BORING ADVANCED USING 5/4" SOLID STEM AUGERS, CONTINUOUS SPT, AND 2 WIRELINE CORING TOOLS

* POCKET PENETROMETER READINGS
 ** METHOD OF ADVANCING AND CLEANING BORING

PROJECT AREA #3 JOHN E. AMOS POWER PLANT ST. ALBANS, WV BORING NO. B-0508
 ELEVATION 982± GWL 0 HRS 87.3 PROJECT NO. C040384-10-01
 DATE 27-28 APR 2005 CLASSIFIED BY DYAN SANGER PAGE 2 of 7

DEPTH (FT.)	BLOWS PER SIX INCHES OR CORE RECOVERY/RUN	CORE RECOVERY/RUN SAMPLE NO., TYPE & RECOVERY OR % ROCK RECOVERY	RQD (%) OR TORVANE	PROFILE	DESCRIPTION			USCS OR ROCK BROKENNESS	REMARKS*
					SOIL DENSITY - CONSISTENCY OR ROCK HARDNESS	COLOR	MATERIAL CLASSIFICATION		
1	2	3	4	5	6	7	8	9	10
30.9	◆				SSFT	MAROON	CLAYSTONE	NBR	LOW & FRACTURES W/ SLICKENSIDES 31.0, 31.15, 31.3, 31.5, 32.4, 33.0, NEAR VERTICAL FRACTURE 31.8, 32.1
		91.6	100%	96%		GRAY			70° FRAC. W/ SLICKENSIDES 32.4-32.65
				38.5		MAROON			30° FRAC. W/ SLICK. 34.2
					M.S. FT	OLIVE-GRAY	SHALY SANDSTONE - V. FINE GRAINED	BR	LOW & FRACTURE 35.8, 37.3, 37.5, 37.85
40.9	◆								LOW & ORANGE STAINED FRACTURE 39.0
									NEAR VERTICAL & TAIHO FRACTURE 39.4-39.7
				45.3					HIGH & FRACTURE 40.4
		10.0	10.0	100%	91				BROKEN 40.4-40.9
				46.2	SOFT TO M. HARD	BROWN-GRAY	SANDSTONE - FINE TO MED. GRAINED, MICACEOUS	BR-BL	LOW & FRACTURE 43.0
				51.0					
				51.9	M. SOFT	OLIVE	SANDY SHALE		
					M. SOFT TO M. HARD	OLIVE-GRAY	SANDSTONE		
				54.3					
				56.0	M. SOFT	OLIVE	SANDY SHALE		
		10.0	10.0	100%	87	MAROON & GRAY	CLAYSTONE	BR	BROKEN ZONE 55.2-55.4
									LOW & FRACTURE 56.6, 57.75
				59.7					

REMARKS ** _____

* POCKET PENETROMETER READINGS
 ** METHOD OF ADVANCING AND CLEANING BORING

PROJECT AREA 2/3 JOHN E. AMOS POWER PLANT SR. ALBANS, WV
ELEVATION 982± GWL 0 HRS 87.3

BORING NO. B-0508
PROJECT NO. C04038440-01

DATE 27-28 APR 2005 CLASSIFIED BY DAN SANGER

PAGE 3 of 7

DEPTH (FT.)	BLOWS PER SIX INCHES OR CORE RECOVERY/RUN	SAMPLE NO., TYPE & RECOVERY OR % ROCK RECOVERY	RQD (%) OR TORVANE	DESCRIPTION				USCS OR ROCK BROKENNESS	REMARKS*
				PROFILE	SOIL DENSITY - CONSISTENCY OR ROCK HARDNESS	COLOR	MATERIAL CLASSIFICATION		
1	2	3	4	5	6	7	8	9	10
60.9	◆			60.8	M. SOFT	GRAY	SANDY CLAYSTONE	BL	
					SOFT	GRAY	CLAY SHALE	BR	LOW # FRACTURES 61.5
				64.2					62.2, STAINED 45° FRACTURE
	10.0	10.0	100%	65.8		GRAY + MAROON	CLAY SHALE, TRACE SAND	BL	62.6-62.8, 63.6-63.8.
					SOFT TO V. SOFT	MAROON	CLAYSTONE - WEATHERED		STAINED VERTICAL FRAC 64.2-64.3, 64.7-64.8, 65.3-65.45
70.9	◆								45° FRACTURES 72.9, 73.5
				73.5				BR	
				74.0			SANDY SHALE		
	10.0	10.0	100%	75	M. SOFT TO M. HARD	GRAY	SANDSTONE: V. FINE TO FINE GRAINED		SHALE PARTING 77.6
80.9	◆								
				82.0					
					M. HARD	GRAY	SANDSTONE: FINE TO MEDIUM GRAINED	BL	
	9.3	10.0	93%	71					
				88.1					STAINED VERTICAL FRACTURE 87.6-88.15
					SOFT	DIS GRAY	CLAYSTONE	BR	30° FRAC. 4 SICKEN SIDES 88.9

REMARKS **

* POCKET PENETROMETER READINGS
** METHOD OF ADVANCING AND CLEANING BORING

PROJECT AREA 73 JOHN E. AMOS POWER PLANT ST. ALBANS WV BORING NO. B-0508
 ELEVATION 982± GWL 0 HRS 87.3 PROJECT NO. CV4038440-01
 DATE 27-28 APR 2005 CLASSIFIED BY DAN SANGER PAGE 4 of 7

DEPTH (FT.)	BLOWS PER SIX INCHES OR CORE RECOVERY/RUN	CORE RECOVERY/RUN SAMPLE NO., TYPE & RECOVERY OR % ROCK RECOVERY	RQD (%) OR TORVANE	DESCRIPTION				USCS OR ROCK BROKENNESS	REMARKS*	
				PROFILE	SOIL DENSITY - CONSISTENCY OR ROCK HARDNESS	COLOR	MATERIAL CLASSIFICATION			
1	2	3	4	5	6	7	8	9	10	
90.9	◆				SOFT	DK GRAY	CLAYSTONE (CONT)	BR	45° SLICKENSIDED FRACTURES 92.0-92.1, 92.55-92.65	
									BROKEN 92.9-93.2	
									30° SLICKENSIDED FRACTURES AT 93.0, 93.25, 93.6, 93.9, 94.3	
	100	100	100%	37	92.4					
					M-SOFT TO M. HARD	GRAY	SILTY FINE GRAINED SANDSTONE	BL	45° FRACTURES & SLICKENSIDES 94.05, 94.85, 95.75	
100.9	◆								NEAR VERTICAL FRAC-	
					101.1					
					101.2	SOFT	GRAY + MAROON	CLAYSTONE	UBR	TWICE 98.5-99.0
						M-SOFT	GRAY	SILTSTONE	BL	60° FRACTURES & SLICKENSIDES 101.6-101.9, INTERSECTED BY 45° SLICKENSIDE @ 104.5
					104.0					
					105.2	SOFT	MAROON + GRAY MOTTLED	CLAYSTONE	BR	VERTICAL FRACTURE (NO STAINING) 105.4-106.8
	10.0	10.0	100%	75	106.8	M. HARD	GRAY	SANDSTONE		
					108.9	M-SOFT	GRAY	SILTSTONE	BL	
						SOFT TO M-SOFT	MAROON + GRAY MOTTLED	SILTY CLAYSTONE	BR	30° SLICKENSIDE 111.3
110.9	◆									
					112.3					
						M-SOFT	GRAY	SILTSTONE		SHALE PARTING 114.3
					114.7					
	10.0	10.0	100%	92	116.0		GRAY	SANDSTONE - FINE GRAINED SILTSTONE		

REMARKS ** _____

* POCKET PENETROMETER READINGS
 ** METHOD OF ADVANCING AND CLEANING BORING

PROJECT AREA #13, JOHN G. AMOS POWER PLANT ST. ALBANS, WV

BORING NO. B-0508

ELEVATION 982± GWL 0 HRS 87.3

PROJECT NO. CU40384.40-01

DATE 27-28 APR 2005

HRS CLASSIFIED BY DAN SANGER

PAGE 5 of 7

DEPTH (FT.)	BLOWS PER SIX INCHES OR CORE RECOVERY/RUN	CORE RECOVERY/RUN SAMPLE NO., TYPE & RECOVERY OR % ROCK RECOVERY	RQD (%) OR TORVANE	DESCRIPTION				USCS OR ROCK BROKENNESS	REMARKS*
				PROFILE	SOIL DENSITY - CONSISTENCY OR ROCK HARDNESS	COLOR	MATERIAL CLASSIFICATION		
1	2	3	4	5	6	7	8	9	10
120.9	◆			120.1	M. HARD	GRAY	SANDSTONE	BR	HEAVILY STAINED VERTICAL
				121.5	↓	↓	↓	↓	↓ FRACTURE 120.2-122.2
				123.4	M. SOFT	GRAY	SILTSTONE	BL	SHALE PART. NO. 122.3
					M. HARD	GRAY	SANDSTONE	BL	
	10.0	10.0	100%	125.5	↓	↓	↓	↓	
			85		M. SOFT	GRAY	ARGILLACEOUS SILTSTONE	BL	
130.9	◆								
	10.0	10.0	100%						
			79						
				132.4	↓	↓	↓	↓	
					M. SOFT TO M. HARD	GRAY	SANDY SILTSTONE w/ THIN INTERMITTENT SANDSTONE STRINGERS	BR	NEAR VERTICAL FRACTURE (NO STAINING)
				140.0	↓	↓	↓	↓	138.1-140.0
140.9	◆			141.4	M. SOFT	GRAY	ARGILLACEOUS SILTSTONE	BR	SUCKEN SIDES 141.2
					SOFT	GRAY-MAROON-YELLOW	CLAYSTONE		LOW & SUCKEN SIDES 141.8, 142.0, 143.5
						GRAY			30° SUCKEN SIDES 142.3, 142.5, 142.75, 144.9, 145.6
	10.0	10.0	100%	146.0	↓	↓	↓	↓	
			78	147.2	M. HARD	LT GRAY	SANDSTONE; MICACEOUS		
							INTERBEDDED SHALY SILTSTONE AND SILTY SHALE		
				150.0	↓	↓	↓	↓	

REMARKS **

* POCKET PENETROMETER READINGS
** METHOD OF ADVANCING AND CLEANING BORING

PROJECT AREA 2/3 JOHN E. AMOS POWER PLANT ST. ALBANS, WV BORING NO. B-0508
 ELEVATION 982± GWL 0 HRS 87.3 PROJECT NO. C040384.40-01
 DATE 27-28 APRIL 2005 CLASSIFIED BY DAN SANGER PAGE 6 of 7

DEPTH (FT.)	BLOWS PER SIX INCHES OR CORE RECOVERY/RUN	CORE RECOVERY/RUN SAMPLE NO., TYPE & RECOVERY OR % ROCK RECOVERY	RQD (%) OR TORVANE	PROFILE	DESCRIPTION			USCS OR ROCK BROKENNESS	REMARKS*
					SOIL DENSITY - CONSISTENCY OR ROCK HARDNESS	COLOR	MATERIAL CLASSIFICATION		
1	2	3	4	5	6	7	8	9	10
150.9	◆			150.0	M. HARD	GRAY	SANDSTONE: FINE TO MEDIUM GRAINED, MICACEOUS	BL	
	10.0	10.0	100%	100					
160.9	◆								
	10.0	10.0	100%	100					
170.9	◆								
				873.0	M. SOFT	GRAY	ARGILLACEOUS SILTSTONE	BR-BL	PARTING 173.4, 176.25
	10.0	10.0	100%	96					
				172.8	M. SOFT TO M. HARD	LT. GRAY	SHALY SANDSTONE: MICACEOUS	BL	

REMARKS ** _____

* POCKET PENETROMETER READINGS
 ** METHOD OF ADVANCING AND CLEANING BORING

PROJECT AREA 2/3 JOHN E. AMOS POWER PLANT ST. ALBANS, WV BORING NO. B-0508
 ELEVATION 982 ± GWL 0 HRS 87.3 PROJECT NO. C040384.41-01
 DATE 27-28 APR 2005 CLASSIFIED BY DAN SANGER PAGE 7 of 7

DEPTH (FT.)	BLOWS PER SIX INCHES OR CORE RECOVERY/RUN	CORE RECOVERY/RUN SAMPLE NO., TYPE & RECOVERY OR % ROCK RECOVERY	RQD (%) OR TORVANE	DESCRIPTION				USCS OR ROCK BROKENNESS	REMARKS*
				PROFILE	SOIL DENSITY - CONSISTENCY OR ROCK HARDNESS	COLOR	MATERIAL CLASSIFICATION		
1	2	3	4	5	6	7	8	9	10
180.9	◆			181.6	M. S. FT	GRAY	SILTSTONE		
				184.3	SOFT TO M. SOFT	GRAY	SILTY CLAYSTONE	BA-BL	
	10.0	10.0	100%	79		MARBLE GRAY	: SANDY 187.3-188.8		40° SLICKENSIDES 185.6-185.75, 186.6-186.7, 186.9-187.05
									30° SLICKENSIDES 186.9, 187.2, 187.3
190.9	◆					MARBLE AND GRAY	: 191.8-200.9 IRREGULAR CALCAREOUS CLASTS AND STRINGERS THROUGHOUT	BL	
	10.0	10.0	100%	96				BR	
200.9	▲								BOTTOM OF BORING: 200.9'

REMARKS ** _____

N 541748.6664
 E 1724111.6219 Grade El. 824.40



PROJECT AREA 2/3 JOHN E. AMOS POWER PLANT ST. ALBANS, WV BORING NO. B-0509
 ELEVATION 825± GWL 0 HRS 53.4 PROJECT NO. C040384.40-01
 23 HRS 16.0 (after lock-in)
 DATE 2 APR - 02 MAY 2005 CLASSIFIED BY DAN SANGER PAGE 1 of 4

DEPTH (FT.)	BLOWS PER SIX INCHES OR CORE RECOVERY/RUN	CORE RECOVERY/RUN SAMPLE NO., TYPE & RECOVERY OR % ROCK RECOVERY	RQD (%) OR TORVANE	DESCRIPTION				USCS OR ROCK BROKENNESS	REMARKS*
				PROFILE	SOIL DENSITY - CONSISTENCY OR ROCK HARDNESS	COLOR	MATERIAL CLASSIFICATION		
1	2	3	4	5	6	7	8	9	10
1.5	2	S-1 REC 1.0			M. STIFF	TAN	SILTY CLAY MOIST	CI	± 0.75 TSF
3.0	3	S-2 REC 1.2			↓		↓	↓	± 1.5 TSF
4.5	4	S-3 REC 1.5			M. DENSE		CLAYEY SILT : DECOMPOSED	MI	DRY
6.0	13	S-4 REC 1.5			↓	TAN + GRAY	CLAYSTONE	↓	DRY
7.5	6	S-5 REC 1.5			M. DENSE		↓	↓	DRY
9.0	15	S-6 REC 1.4			↓		↓	↓	
10.5	5	S-7 REC 1.5			V. STIFF		SILTY CLAY : DECOMPOSED	CI	SLIGHTLY MOIST ± 3.5 TSF
12.0	10	S-8 REC 1.5			V. STIFF		CLAYSTONE		" " "
13.5	9	S-9 REC 1.5			V. STIFF				" " ± 4.0 TSF
15.0	10	S-10 REC 1.5			↓		↓	↓	" " ± 4.0 TSF
16.5	4	S-11 REC 1.5			V. STIFF		THICK ROCK FRAGMENT	↓	" " ± 3.25 TSF
18.0	8	S-12 REC 1.5			M. DENSE		CLAYEY SILT : DECOMPOSED CLAYSTONE	MI	" "
19.5	6	S-13 REC 1.5			↓		↓	↓	
21.0	8	S-14 REC 1.5			STIFF		SILTY CLAY : DECOMPOSED CLAYSTONE	CI	MOIST ± 1.5 TSF
22.5	3	S-15 REC 1.5			STIFF				MOIST ± 1.75 TSF
24.0	5	S-16 REC 1.5			↓		↓	↓	
25.5	10	S-17 REC 1.5			N-STIFF				MOIST ± 2.25 TSF
25.9	5	S-18 REC 1.5			STIFF				MOIST ± 2.0 TSF
	10	S-19 REC 1.5			↓		↓	↓	
	10	S-20 REC 1.5			STIFF				MOIST ± 1.5 TSF
	10	S-21 REC 1.5			M. DENSE	GRAY	DECOMPOSED SANDSTONE	↓	
	10	S-22 REC 1.5			V. DENSE	GREEN-GRAY	↓	↓	TOP OF ROCK: 25.9
	10	S-23 REC 1.5			SOFT	BROWN	SANDSTONE - HIGHLY TO COMPLETELY WEATHERED	UBR	
	1.1	6.1	18%	0					

REMARKS ** DRILLED BY TERRA TESTING, INC. USING A SIMCO 4000-T2 TRACK MOUNTED DRILL
 BORING ADVANCED USING 5/4 SOLID STEM AUGERS, 4" I.D. STEEL CASING, NO-2 WIRELINE WIRING TOOLS.

* POCKET PENETROMETER READINGS BORING NO. B-0509
 ** METHOD OF ADVANCING AND CLEANING BORING (7)

PROJECT AREA 2/3 JOHN E. AMOS POWER PLANT ST. ALBANS, WV BORING NO. B-0509
 ELEVATION 825± GWL 0 HRS 53.4 PROJECT NO. C040384.43-01
 22 HRS 16.0
 DATE 28 APR - 02 MAY 2005 CLASSIFIED BY DAN SANGER PAGE 2 of 4

DEPTH (FT.)	BLOWS PER SIX INCHES OR CORE RECOVERY/RUN	SAMPLE NO., TYPE & RECOVERY OR % ROCK RECOVERY	ROD (%) OR TORVANE	DESCRIPTION				USCS OR ROCK BROKENNESS	REMARKS*
				PROFILE	SOIL DENSITY - CONSISTENCY OR ROCK HARDNESS	COLOR	MATERIAL CLASSIFICATION		
1	2	3	4	5	6	7	8	9	10
32.0	◆			32.0	SOFT	MAROON	CLAYSTONE	BR-BL	
42.0	◆	71	46		M. SOFT	GREEN-GRAY	IRREGULAR CALCAREOUS CLASTS AND FRAGMENTS (TO 1/3')		LOW & FRAG. WITH SW DISCONTINUES 44.4, 44.55, 46.2, 46.45, 46.95, 47.4, 49.0
52.0	◆	98	79	49.7 50.4	M. HARD	LT GRAY	SANDSTONE		
					M. SOFT	GREEN-GRAY	CLAYSTONE		
				53.9	M. SOFT	GREEN-GRAY	SILTY TO SANDY CLAYSTONE	BR-BL	LOW & FRAG. WITH SW DISCONTINUES 54.9, 55.5, 57.2, 58.7, 59.0, 60.0
		100	85				IRREGULAR MAROON CLAYSTONE CLASTS		
							SANDY 56.7 TO 57.3		

REMARKS **

* POCKET PENETROMETER READINGS
 ** METHOD OF ADVANCING AND CLEANING BORING

PROJECT AREA ^{2/3} JOHN E. AMOS POWER PLANT ST. ALBANS WV

BORING NO. B-0509

ELEVATION 825± GWL 0 HRS 53.4

PROJECT NO. C040384.40-01

23 HRS 16.0

DATE 28 APR - 02 MAY 2005 CLASSIFIED BY DAN SANGER

PAGE 3 of 4

DEPTH (FT.)	BLOWS PER SIX INCHES OR CORE RECOVERY/RUN	SAMPLE NO., TYPE & RECOVERY OR % ROCK RECOVERY	FOD (%) OR TORVANE	DESCRIPTION				USCS OR ROCK BROKENNESS	REMARKS*
				PROFILE	SOIL DENSITY - CONSISTENCY OR ROCK HARDNESS	COLOR	MATERIAL CLASSIFICATION		
1	2	3	4	5	6	7	8	9	10
62.0	◇						CLAYSTONE (CONT)		LOW & FRACTURES 62.2, 62.6, 62.8, 63.4, 63.7, 64.1, 64.3, 64.5, 64.9, 65.2
10.0	◇	100%	67	66.5	M. SOFT	GRAY	INTERBEDDED SILTSTONE AND CLAYSTONE	PL	
72.0	◇								
10.0	◇	100%	92	76.6	M. HARD	GRAY	SANDSTONE	BL	
82.0	◇			81.2	M. SOFT	DK GRAY	SILTY TO SANDY SHALE	BR	LOW & FRACTURES 81.3, 81.45, 82.7, 83.1, 83.6
				83.8	SOFT	GRAY	CLAYSTONE		LOW & FRACTURES 83.9, 84.1, 84.2, 84.7, 85.1, 85.5 HIGH FRACTURE/SPLITTING SURF 87.0-87.2
10.0	◇	100%	77				: BECOMES SILTY @ 87.5		

REMARKS **

* POCKET PENETROMETER READINGS
** METHOD OF ADVANCING AND CLEANING BORING

PROJECT AREA 2/3 JOHN E. AMOS POWER PLANT

BORING NO. B-0509

ELEVATION 825 ± GWL 0 HRS 53.4

PROJECT NO. C040384.40-01

23 HRS 16.0

DATE 28 APR - 02 MAY 2005 CLASSIFIED BY

PAGE 4 of 4

DEPTH (FT.)	BLOWS PER SIX INCHES OR CORE RECOVERY/RUN	CORE RECOVERY/RUN SAMPLE NO., TYPE & RECOVERY OR % ROCK RECOVERY	RQD (%) OR TORVANE	DESCRIPTION				USCS OR ROCK BROKENNESS	REMARKS*
				PROFILE	SOIL DENSITY - CONSISTENCY OR ROCK HARDNESS	COLOR	MATERIAL CLASSIFICATION		
1	2	3	4	5	6	7	8	9	10
92.0	◆			91.0	↓	↓	↓	↓	
					M. HARD	LT GRAY	SANDSTONE	BL	
				93.6	↓	↓	↓	↓	
					SOFT TO M. HARD		CLAYSTONE	BL	
	80	80	100%	62	M. SOFT				30° FRACTURES 95.1, 95.6, 96.4, 97.3, 98.4, 98.6
				98.9	↓	↓	↓	↓	60° SLICKENSIDE 98.0-98.2
100.7	▲			100.0	M. HARD	GRAY	SILTY SHALE/SILTSTONE	BL	
							BOTTOM OF BORING 100.0		

REMARKS **

* POCKET PENETROMETER READINGS
** METHOD OF ADVANCING AND CLEANING BORING

N 540879.8326
 E 1722795.6504 Grade El. 925.74



PROJECT AREA 2/3 JOHN E. AMOS POWER PLANT ST. ALBANS, WV BORING NO. B-0510
 ELEVATION _____ GWL 0 HRS 36.0 PROJECT NO. C040324.40-01
 DATE 03-04 MAY 2005 CLASSIFIED BY DAN SANGER PAGE 1 of 9

DEPTH (FT.)	BLOWS PER SIX INCHES OR CORE RECOVERY/RUN	CORE RECOVERY/RUN SAMPLE NO., TYPE & RECOVERY OR % ROCK RECOVERY	RQD (%) OR TORVANE	DESCRIPTION				USCS OR ROCK BROKENNESS	REMARKS*
				PROFILE	SOIL DENSITY - CONSISTENCY OR ROCK HARDNESS	COLOR	MATERIAL CLASSIFICATION		
1	2	3	4	5	6	7	8	9	10
1.5	1	S-1			V. LOOSE	TAN	SANDY SILT	MI	MOIST
3.0	4	REC 1.2 S-2			M. DENSE	TAN + GRAY	CLAYEY SILT	MI	SLIGHTLY MOIST
4.5	7	REC 1.3 S-3			V. STIFF		SILTY CLAY	CI	DRY
6.0	10	REC 1.2 S-4			V. STIFF	GRAY	SILTY CLAY	CI	DRY
7.5	13	REC. S-5			HARD	GRAY	SILTY CLAY: DECOMPOSED CLAYSTONE		DRY
8.4	14	S-6 REC. 0.9		8.4	HARD	MAROON + YELLOW	DECOMPOSED CLAYSTONE		
10.7	23	100% S-7	30	11.4	SOFT	LT. BROWN	INTERBEDDED CLAY SHALE AND CLAYEY SILTSTONE: HIGHLY WEATHERED	BR	TOP OF ROCK 8.4 HEAVILY STAINED HIGH & FRACTURE 9.4, 9.7, LOW & STAINED FRACTURES 9.8, 10.4, 10.7, 11.3, 12.6, 12.75, 13.9,
	100	100%	58	14.0	M. SOFT	BROWN	SANDSTONE: WEATHERED TO ~15.25, MICACEOUS, FINE TO MEDIUM GRAINED	BA-BL	STAINED LOW & FRACTURES 17.0, 17.3, 18.0
20.7				20.7	M. LTRAL	GRAY			
				22.0	SOFT	GRAY	CLAYSTONE	UBR	
				23.9	M. SOFT	GRAY	SILTSTONE / SILTY SHALE	BR	STAINED HIGH & FRACTURE (60-70°)
23.0	10.0	100%	65		SOFT	LT. GRAY	CLAYSTONE	VBR-	22.8-23.0
						OK GRAY MAROON		BR	NEAR VERTICAL PARTIALLY STAINED FRACTURE 23.3-23.9

REMARKS ** DRILLED BY TERRA TESTING, INC. USING A SIMCO 4000-T2 TRACK MOUNTED DILL
 BORING ADVANCED USING 5 1/4" SOLID STEM AUGERS, 4" I.D. STEEL CASING, NCR-2 WIRELINE COR. ALB. TDSI?

* POCKET PENETROMETER READINGS
 ** METHOD OF ADVANCING AND CLEANING BORING

PROJECT AREA 2/3 JOHN E. MASS POWER PLANT

ST. ALBANS WV

BORING NO. B-0510

ELEVATION _____ GWL 0 HRS 36.0

PROJECT NO. C040384-1-01

DATE 03-04 MAY 2005

CLASSIFIED BY DALSANGER

PAGE 2 of 9

DEPTH (FT.)	BLOWS PER SIX INCHES OR CORE RECOVERY/RUN	CORE RECOVERY/TYPE & RECOVERY OR % ROCK RECOVERY	RQD (%) OR TORVANE	DESCRIPTION						USCS OR ROCK BROKENNESS	REMARKS*
				PROFILE	SOIL DENSITY - CONSISTENCY OR ROCK HARDNESS	COLOR	MATERIAL CLASSIFICATION				
1	2	3	4	5	6	7	8	9	10		
30.7	◆				SOFT		CLAYSTONE (CONT) HIGHLY WEATHERED	BR-BL			
					↓		↓	↓			
				35.0	↓		↓	↓			
	9.5	10.0	95%	60	M. SOFT → GREENISH GRAY		INTERBEDDED SILTY CLAYSTONE WITH CALCAREOUS CLASTS AND SANDY SILTSTONE	BR-BL	30° FRACTURE 36.2 60° FRACTURE 36.2-36.65		
					M. HARD						
					↓			↓			
40.7	◆				MAROON			VRB			
					↓			↓			
					GRAY			BL			
					↓			↓			
	10.0	10.0	100%	91	MAROON → GRAY MOTTLED				LOW 8 FRACTURE 45.8 46.0, 48.0, 52.5, 52.6 53.5, 55.1, 55.5, 57.85		
					↓			↓			
50.7	◆							BR			
								↓			
	10.0	10.0	100%	76					SLIGHTLY STAINED VERTICAL FRACTURE 55.75-56.1		
					↓			↓			

REMARKS **

* POCKET PENETROMETER READINGS

** METHOD OF ADVANCING AND CLEANING BORING

PROJECT AREA 2/3 JOHN E. AMOS POWER PLANT ST. ALBANS, WV BORING NO. B-0510
 ELEVATION _____ GWL 0 HRS 36.0 PROJECT NO. C040384.40-01
 DATE 03-04 MAY 2005 CLASSIFIED BY DAN SANGER PAGE 3 of 9

DEPTH (FT.)	BLOWS PER SIX INCHES OR CORE RECOVERY/RUN	SAMPLE NO., TYPE & RECOVERY OR % ROCK RECOVERY	RQD (%) OR TORVANE	DESCRIPTION				USCS OR ROCK BROKENNESS	REMARKS*
				PROFILE	SOIL DENSITY - CONSISTENCY OR ROCK HARDNESS	COLOR	MATERIAL CLASSIFICATION		
1	2	3	4	5	6	7	8	9	10
60.7	◆				M-SFT	MAA001 GRAY	INTERBEDDED CLAYSTONE AND SILTSTONE (CONT)	BR-BL	LOW \angle FRACTURES 61.1, 61.6, 62.0, 63.2 63.5, 63.75, 63.9, 64.65, 65.0
	10.0	10.0	100%	92					
70.7	◆						SANDY SILTSTONE 73.0-75.0		
	10.0	10.0	100%	96					
80.7	◆							BR	30° SLICKENSIDES 81.3, 81.5, 81.8, 82.1, 82.7, 82.9, 83.8, 84.1
	10.0	10.0	100%	60					
				87.6	↓	↓	↓	↓	
					M. HARD	GRAY	SANDSTONE FINE TO MEDIUM GRAINED, MICACEOUS	BL	

REMARKS ** _____

PROJECT AREA 2/3 JOHN E. AMOS POWER PLANT ST. ALBANS, WV BORING NO. B-0510
 ELEVATION _____ GWL 0 HRS 36.0 PROJECT NO. C040384.40-01
 DATE 03-04 MAY 2005 CLASSIFIED BY DAN SANGER PAGE 4 of 9

DEPTH (FT.)	BLOWS PER SIX INCHES OR CORE RECOVERY/RUN	SAMPLE NO., TYPE & RECOVERY OR % ROCK RECOVERY	RQD (%) OR TORVANE	DESCRIPTION					USCS OR ROCK BROKENNESS	REMARKS*
				PROFILE	SOIL DENSITY - CONSISTENCY OR ROCK HARDNESS	COLOR	MATERIAL CLASSIFICATION			
1	2	3	4	5	6	7	8	9	10	
90.7	◆				M. HARD	LT GRAY	SANDSTONE (CWT)	BL		
	10.0	100%	100%							
100.7	◆									
	10.0	100%	100%							
110.7	◆									
				112.0						
					M-SFT M-HARD	GRAY	INTERBEDDED SANDSTONE AND SILTSTONE, SOME THIN SHALE UNITS	BR- BL	LOW FRACTURE 112.4, 114.4, 114.55, 114.7, 119.1	
	10.0	100%	91							

REMARKS ** _____

* POCKET PENETROMETER READINGS
 ** METHOD OF ADVANCING AND CLEANING BORING

PROJECT AREA 2/3 JOHN E. ANDS POWER PLANT ST. ALBANS, VT BORING NO. B-0510
 ELEVATION _____ GWL 0 HRS 36.0 PROJECT NO. C040384.40-01
 DATE 03-04 MAY 2005 CLASSIFIED BY DAN SANGER PAGE 5 of 9

DEPTH (FT.)	BLOWS PER SIX INCHES OR CORE RECOVERY/RUN	CORE RECOVERY/RUN SAMPLE NO., TYPE & RECOVERY OR % ROCK RECOVERY	RQD (%) OR TORVANE	DESCRIPTION				USCS OR ROCK BROKENNESS	REMARKS*
				PROFILE	SOIL DENSITY - CONSISTENCY OR ROCK HARDNESS	COLOR	MATERIAL CLASSIFICATION		
1	2	3	4	5	6	7	8	9	10
120.7	◆			121.5					
					SOFT TO M. SOFT	GRAY + MAROON	CLAYSTONE IRREGULAR CALCAREOUS CLASTS + STRINGERS: 122.6 - 124.0, 135.0 - 138.7	BA - VBR	LOW & FRACTURED SLICKENSIDES 122.35, 122.8, 123.35, 124.02, 124.7, 124.9, 125.4, 126.1, 127.65, 128.3, 129.1, 130.1, 130.45, 130.7, 131.5, 131.9, 132.6, 134.5, 135.3
	10.0	10.0	100%	47					
130.7	◆								HIGH & SLICKENSIDE 133.25 - 133.6
	10.0	10.0	100%	60					
140.7	◆			140.7	M. SOFT	GREEN-GRAY, MAROON, YELLOW MOTTLED	SILTY CLAYSTONE: INTERMITTENT IRREGULAR CALCAREOUS CLASTS AND STRINGERS	BR	MOST PIECES 0.2 - 0.4' LONG
	10.0	10.0	100%	73					

REMARKS ** _____

* POCKET PENETROMETER READINGS
 ** METHOD OF ADVANCING AND CLEANING BORING

PROJECT AREA 2/3 JOHN E. AMOS POWER PLANT

BORING NO. B-0510

ELEVATION _____ GWL 0 HRS 36.0

PROJECT NO. C043384.40-1

HRS _____

DATE 03-MAY-2005

CLASSIFIED BY DAN SANGER

PAGE 6 of 9

DEPTH (FT.)	BLOWS PER SIX INCHES OR CORE RECOVERY/RUN	CORE RECOVERY/RUN SAMPLE NO., TYPE & RECOVERY OR % ROCK-RECOVERY	RQD (%) OR TORVANE	DESCRIPTION				USCS OR ROCK BROKENNESS	REMARKS*
				PROFILE	SOIL DENSITY - CONSISTENCY OR ROCK HARDNESS	COLOR	MATERIAL CLASSIFICATION		
1	2	3	4	5	6	7	8	9	10
150.7	◆						SILTY CLAYSTONE (CONT)		
				153.2					
					M-HALD	LT GRAY	SANDSTONE: FINE TO MEDIUM GRAINED, M.A. CEDUS	BL	
	10.0	10.0	100%	84					1 PIECE OF CORE: 7.6'
160.7	◆								
									1 PIECE OF CORE 6.7'
	10.0	10.0	100%	100					
170.7	◆								
				175.1					
	10.0	10.0	100%	53	SOFT TO M-SFT	GRAY + MAROON	CLAYSTONE	VBR	MOST PIECES 0.2' ~30° SLICKEN SIDES
									176.0, 176.35, 177.55, 177.7, 178.1, 178.45, 178.65, 179.0, 179.1-179.35, 179.65-179.85

REMARKS ** _____

* POCKET PENETROMETER READINGS
** METHOD OF ADVANCING AND CLEANING BORING

BORING NO. B-0510

(26)

PROJECT AREA 2/3 JOHN E. AMOS POWER PLANT ST. ALBANS, WV BORING NO. B-0510
 ELEVATION _____ GWL 0 HRS 36.0 PROJECT NO. C040384.40-01
 DATE 03-14 MAY 2005 CLASSIFIED BY DAN SANGER PAGE 7 of 9

DEPTH (FT.)	BLOWS PER SIX INCHES OR CORE RECOVERY/RUN	CORE RECOVERY/TYPE & SAMPLE NO., TYPE & RECOVERY OR % ROCK RECOVERY	RQD (%) OR TORVANE	DESCRIPTION				USCS OR ROCK BROKENNESS	REMARKS*
				PROFILE	SOIL DENSITY - CONSISTENCY OR ROCK HARDNESS	COLOR	MATERIAL CLASSIFICATION		
1	2	3	4	5	6	7	8	9	10
180.7	◆			181.5			CLAYSTONE (CONT)		
					M. SOFT	GRAY	SANDY SILTSTONE	BA-BL	
					↓	↓	↓	↓	
	10.0	10.0	100%	84	185.8				
					SOFT TO M. SOFT	MARL	CLAYSTONE	BA	LOW SLICKENSIDES 187.0, 187.6, 187.8, 189.0
					↓	↓	↓	↓	
190.7	◆			190.2					
					M. HARD	LT GRAY	SILTY SANDSTONE	BL	
					↓	↓	↓	↓	
					194.0				
	10.0	10.0	100%	81	M. SOFT	GRAY + MARL	INTERBEDDED SANDY CLAYSTONE AND SILTSTONE	BR	LOW SLICKENSIDES 194.15, 196.1, 196.75, 197.15, 197.5, 197.85, 198.2,
					↓	↓	↓	↓	
					198.2				
					M. SOFT TO M. HARD	GRAY + LT GRAY	INTERBEDDED SILTSTONE AND SANDSTONE	BA-BL	
200.7	◆								
					↓	↓	↓	↓	
					203.0				
					SOFT TO M. SOFT	MARL	SILTY CLAYSTONE	BR	LOW SLICKENSIDES 204.25, 205.0, 205.25, 205.8, 206.7, 206.85, 207.25, 207.7, 207.85
	10.0	10.0	100%	70					
					↓	↓	↓	↓	
					209.7				
					↓	↓	↓	↓	

REMARKS ** _____

* POCKET PENETROMETER READINGS
 ** METHOD OF ADVANCING AND CLEANING BORING

PROJECT AREA 2/3 JOHN E. AMOS POWER PLANT ST. ALBANS, WV BORING NO. B-0510
 ELEVATION _____ GWL 0 HRS 36.0 PROJECT NO. C040384 (A-D)
 DATE 03-24 MAY 2006 CLASSIFIED BY DAN SANGER PAGE 8 of 9

DEPTH (FT.)	BLOWS PER SIX INCHES OR CORE RECOVERY/RUN	CORE RECOVERY/TYPE & SAMPLE NO., TYPE & RECOVERY OR % ROCK RECOVERY	RQD (%) OR TORVANE	DESCRIPTION				USCS OR ROCK BROKENNESS	REMARKS*
				PROFILE	SOIL DENSITY - CONSISTENCY OR ROCK HARDNESS	COLOR	MATERIAL CLASSIFICATION		
1	2	3	4	5	6	7	8	9	10
210.7	◆				M. SOFT	GRAY	SILTY SILTSTONE, SOME SAND	BL-BR	
									VERTICAL FRACTURE (NOT STAINED) 212.75 - 214.3
	10.0	10.0	100%	79		GRAY + MAROON GRAY			
220.7	◆			221.3					
					M. SOFT TO SOFT	MAROON + GRAY	SILTY CLAYSTONE	BR-BL	
	10.0	10.0	100%	34				BR	45° SLICKENSIDES 223.0
								VBR	225.2, 226.0, 226.6 226.8
									LOW & SLICKENSIDES 223.75, 224.25, 224.4, 224.7, 224.8, 225.0, 225.4, 225.7, 226.0, 226.1, 226.3
230.7	◆								
	9.7	10.0	97%						226 - 233 VBR
								BR	PIECES 0.1 - 0.2 ✓ SLICKENSIDES (LOW + HIGH &) HIGH & SLICKENSIDES 233.4
									233.9, 234.0, 236.6, 237.6, 238.3, 240.2

REMARKS ** _____

* POCKET PENETROMETER READINGS
 ** METHOD OF ADVANCING AND CLEANING BORING

PROJECT AREA 2/3 JOHN E. AMOS POWER PLANT ST. ALBANS, WV BORING NO. B-0510
 ELEVATION _____ GWL 0 HRS 36.0 PROJECT NO. C040384.4301
 DATE 03-04 MAY 2005 HRS _____ CLASSIFIED BY DAN SANGER PAGE 9 of 9

DEPTH (FT.)	BLOWS PER SIX INCHES OR CORE RECOVERY/RUN	CORE RECOVERY/RUN SAMPLE NO., TYPE & RECOVERY OR % ROCK RECOVERY	RQD (%) OR TORVANE	DESCRIPTION				USCS OR ROCK BROKENNESS	REMARKS*
				PROFILE	SOIL DENSITY - CONSISTENCY OR ROCK HARDNESS	COLOR	MATERIAL CLASSIFICATION		
1	2	3	4	5	6	7	8	9	10
240.7	◆				M. SOFT	MARON + GRAY + PURPLE	CLAYSTONE	VBR	PIECES ~ 0.1-0.2' w/ SUCCESSIONS
								↓	
								BR	30° SUCCESSIONS APPROX. EVERY 3-4-0.5'
	10.0	10.0	100%	56				↓	
				248.3				VBR	
					M. SOFT	MARON + GRAY	INTERBEDDED SANDY CLAYSTONE AND SILTSTONE	BR-BL	
250.7	▲							↓	
							BOTTOM OF BORING: 250.7'		

REMARKS ** _____

* POCKET PENETROMETER READINGS
 ** METHOD OF ADVANCING AND CLEANING BORING

N 542140.8876
E 1724101.7636 Grade El. 784.29



PROJECT AREA 2/3 JOHN E. AMOS POWER PLANT ST. ALBANS, WV BORING NO. B-0512
ELEVATION 795± GWL 0 HRS 206 PROJECT NO. C040384.40-01
DATE 04-05 MAY 2005 CLASSIFIED BY DAN SANGER PAGE 1 of 4

DEPTH (FT.)	BLOWS PER SIX INCHES OR CORE RECOVERY/RUN	CORE RECOVERY/RUN SAMPLE NO., TYPE & RECOVERY OR % ROCK RECOVERY	RQD (%) OR TORVANE	DESCRIPTION				USCS OR ROCK BROKENNESS	REMARKS*
				PROFILE	SOIL DENSITY - CONSISTENCY OR ROCK HARDNESS	COLOR	MATERIAL CLASSIFICATION		
1	2	3	4	5	6	7	8	9	10
1.5	1	S-1			V. LOOSE	BROWN	SILT, TRACE ORGANICS	ml	MOIST
3.0	2	REC 0.8							
3.0	2	S-2			STIFF	BROWN	SILTY CLAY	cl	MOIST * 1.5 TBF
4.5	3	REC 1.0			LOOSE	BROWN	SANDY SILT, SOME ROCK FRAGMENTS	ml	SLIGHTLY MOIST
6.0	5	S-3							
6.0	5	REC 1.3			STIFF	GRAY + BROWN	SILTY CLAY, TRACE ROCK FRAGMENTS	cl	SLIGHTLY MOIST * 1.5 TBF
7.5	1	S-5			M. STIFF	BROWN		cl	WET * 1.0 TBF
9.0	2	REC 0.8		8.0					
9.0	2	S-6			V. DENSE	MARON + GRAY	ROCK FRAGMENTS AND SANDY SILT:	gm	DRY
10.5	3	REC 1.5					DECOMPOSED CLAYSTONE	gm	DRY
12.0	13	S-7							
12.0	13	REC 1.5		12.0					
12.0	18	S-8			M. SOFT	GREEN-GRAY, MARON, PURPLE MOTTLED	SILTY CLAYSTONE	BR	TOP OF ROCK: 12.0'
12.0	50/20.0	S-9 REC 0.0		12.0					
10.0	10.0	100%	40					BR	
22.0				22.15	M. HARD	LT GRAY	SILTY SANDSTONE	BL	
10.0	10.0	100%	91	28.5	M. SOFT TO M. HARD	GRAY	SILTY TO SANDY SHALE	BR-BL	

REMARKS - DRILLED BY TERRA TESTING, INC. USING A SIMCO 4000-T2 TRACK MOUNTED DRILL
BORING ADVANCED USING 5/4" SOLID STEM AUGERS, 4" SA STEEL CASING, HQ-2 WIRELINE CORING TOOLS

* POCKET PENETROMETER READINGS
** METHOD OF ADVANCING AND CLEANING BORING

PROJECT AREA ^{2/3} JOHN E. AMOS POWER PLANT ST. ALBANS, WV

BORING NO. B-0512

ELEVATION 795 ± GWL 0 HRS 2.6

PROJECT NO. C040384.40-01

DATE 04-05 MAY 2005

CLASSIFIED BY DAN SANGER

PAGE 2 of 4

DEPTH (FT.)	BLOWS PER SIX INCHES OR CORE RECOVERY/RUN	CORE RECOVERY/TYPE & SAMPLE NO., TYPE & RECOVERY OR % ROCK RECOVERY	RQD (%) OR TORVANE	DESCRIPTION				USCS OR ROCK BROKENNESS	REMARKS*
				PROFILE	SOIL DENSITY - CONSISTENCY OR ROCK HARDNESS	COLOR	MATERIAL CLASSIFICATION		
1	2	3	4	5	6	7	8	9	10
32.0	◆				M. SOFT TO M. HARD	GRAY	SHALE (CONT)	BA-BL	
				35.7	↓	↓	↓	↓	
	10.0	10.0	100%	95	M. SOFT TO M. HARD	GRAY	INTERBEDDED SANDY SHALE AND SILTSTONE	BL	
42.0	◆				↓	↓	↓	↓	
				42.95	↓	↓	↓	↓	
					SOFT	DK GRAY	CLAYSTONE	BR	LOW X SLICKENSIDES 43.1, 44.15, 45.0, 45.2, 45.8
				46.0	↓	↓	↓	↓	
	10.0	10.0	100%	90	M. SOFT	GRAY	SANDY SHALE	BA-BL	
				47.6	↓	↓	↓	↓	
					SOFT	GRAY + MAROON	CLAYSTONE	BR	
				49.7	↓	↓	↓	↓	LOW X FRACTURE 49.0
					M. SOFT TO M. HARD	LT GRAY	SANDY SILTSTONE	BL	
52.0	◆				↓	↓	↓	↓	
				52.25	↓	↓	↓	↓	
					M. SOFT	MAROON	CLAYSTONE	BR	LOW X SLICKENSIDES 52.55, 53.0, 53.6, 53.85, 54.4, 54.65, 55.35
				57.1	↓	↓	↓	↓	
	9.9	10.0	99%	85	M. SOFT TO M. HARD	LT GRAY	INTERBEDDED SANDY SHALE AND SILTSTONE	BL	
					↓	↓	↓	↓	

REMARKS **

* POCKET PENETROMETER READINGS
** METHOD OF ADVANCING AND CLEANING BORING

PROJECT AREA 2/3 JOHN E. AMOS POWER PLANT ST. ALBANS, WV BORING NO. B-0512
 ELEVATION 795± GWL 0 HRS 2.6 PROJECT NO. C040384.40-01
 DATE 04-05 MAY 2005 CLASSIFIED BY DAN SANGER PAGE 3 of 4

DEPTH (FT.)	BLOWS PER SIX INCHES OR	CORE RECOVERY/RUN	SAMPLE NO., TYPE & RECOVERY OR % ROCK RECOVERY	RQD (%) OR TORVANE	DESCRIPTION			USCS OR ROCK BROKENNESS	REMARKS*
					PROFILE	SOIL DENSITY - CONSISTENCY OR ROCK HARDNESS	COLOR		
1	2	3	4	5	6	7	8	9	10
62.0	◆					M. SOFT TO M. HARD	LT GRAY INTERBEDDED SANDY SHALE AND SILTSTONE (LONIT) CLAYSTONE 62.7-63.2	↓ VBR	
					64.2	↓	↓	↓	
					65.1	SOFT TO M. SOFT	CLAYSTONE	BR	VERTICAL FRACTURE 64.2-64.6
	10.0	10.0	100%	94		M. HARD	LT GRAY SILTY SANDSTONE: FINE TO MEDIUM GRAINED, MICACEOUS	BL	
72.0	◆								
					73.3	↓	↓	↓	
					74.5	M. SOFT	SILTY CLAYSTONE	BR	VERTICAL FRACTURE 75.1-75.3
	10.0	10.0	100%	87		M. HARD	LT GRAY SANDSTONE: MICACEOUS	BL	45° FRACTURE 75.65
82.0	◆								
					85.0	↓	↓	↓	
	9.8	10.0	98%	77		M. SOFT	GRAY SILTSTONE	BR	LOW Z FRACTURES 85.0, 86.35, 86.5, 88.0, 89.3
					89.7	↓	↓	↓	

REMARKS ** _____

PROJECT AREA 2/3 JOHN E. AMOS POWER PLANT BORING NO. B-0512
 ELEVATION 795± GWL 0 HRS 2.6 PROJECT NO. C040384-00-01
 DATE 04-05 MAY 2005 CLASSIFIED BY DAN SANGER PAGE 4 of 4

DEPTH (FT.)	BLOWS PER SIX INCHES OR CORE RECOVERY/RUN	CORE RECOVERY/RUN SAMPLE NO., TYPE & RECOVERY OR % ROCK RECOVERY	RQD (%) OR TORVANE	DESCRIPTION				USCS OR ROCK BROKENNESS	REMARKS*
				PROFILE	SOIL DENSITY - CONSISTENCY OR ROCK HARDNESS	COLOR	MATERIAL CLASSIFICATION		
1	2	3	4	5	6	7	8	9	10
92.0	◆				M.SOFT	MARON + GRAY	INTERBEDDED CLAYSTONE AND SILTSTONE	BR	
					↓	↓	↓	↓	
	12.0	100	100%	67	96.7	↓	↓	↓	
					M.SOFT TO SOFT	OLIVE-GRAY + MARON + YELLOW	CLAYSTONE w/ INTERMITTENT IRREGULAR CALCAREOUS CLASTS + STRINGERS. PITTED CARB SURFACE	BR	
									30° S LICKENSIDE 97.0, 97.2, 97.6, 98.75, 99.25, 99.35, 99.7, 100.1, 100.6, 102.3, 102.5, 103.8, 104.1, 109.15, 109.5, 109.75
102.0	◆							↓	
								BR	
	6.8	8.0	85%	52				↓	
								↓	
110.0	▲				110.0			↓	
BOTTOM OF BORING : 110.0'									

REMARKS ** _____

* POCKET PENETROMETER READINGS
 ** METHOD OF ADVANCING AND CLEANING BORING

N 542140.8876
 E 1724101.7636 Grade El. 784.29



PROJECT AREA 2/3 JOHN E. AMES POWER PLANT ST. ALBANS, WV BORING NO. B-0513
 ELEVATION _____ GWL 0 HRS _____ PROJECT NO. C040384.40-01
 DATE 06 MAY 2005 CLASSIFIED BY DAN SANGER PAGE 1 of 1

DEPTH (FT.)	BLOWS PER SIX INCHES OR CORE RECOVERY/RUN	CORE RECOVERY/RUN SAMPLE NO., TYPE & RECOVERY OR % ROCK RECOVERY	RQD (%) OR TORVANE	PROFILE	SOIL DENSITY - CONSISTENCY OR ROCK HARDNESS	COLOR	DESCRIPTION	USCS OR ROCK BROKENNESS	REMARKS*
							MATERIAL CLASSIFICATION		
1	2	3	4	5	6	7	8	9	10
							BORING NOT DRILLED		
							LOG INCLUDED FOR CON-		
							TINITY AND COMPLETENESS		
							PIEZOMETER INSTALLED		
							IN SAME BORE HOLE		
							AT B-0512		

REMARKS ** _____

N 540555.6419
E 1725145.9412 Grade El. 948.40



PROJECT AREA 2/3 JOHN E. AMOS POWER PLANT, ST. ALBANS, WV BORING NO. B-0514
 ELEVATION _____ GWL 0 HRS 32.1 PROJECT NO. CA-10384.1.12-21
 DATE 09-10 MAY 2005 CLASSIFIED BY DANIEL SANGER PAGE 1 of 5

DEPTH (FT.)	BLOWS PER SIX INCHES OR CORE RECOVERY/RUN	CORE RECOVERY/RUN SAMPLE NO., TYPE & RECOVERY OR % ROCK RECOVERY	RQD (%) OR TORVANE	DESCRIPTION				USCS OR ROCK BROKENNESS	REMARKS*
				PROFILE	SOIL DENSITY - CONSISTENCY OR ROCK HARDNESS	COLOR	MATERIAL CLASSIFICATION		
1	2	3	4	5	6	7	8	9	10
1.5	4	4	S-1		LOOSE	BROWN	SILTY SAND, SOME ROCK FRAGMENTS	SM	
3.0	4	3	S-2		↓	↓	↓	↓	
4.5	2	5	S-3		V. STIFF	MARBLE	SILTY CLAY	CI	* 3.5 TSF
6.0	4	4	S-4		↓	↓	↓	↓	* 3.0 TSF
7.5	7	7	S-5		↓	↓	↓	↓	* 3.0 TSF
9.0	7	10	S-6		↓	↓	↓	↓	
10.5	9	9	S-7		HARD		: DECOMPOSED CLAYSTONE		* > 4.5 TSF
12.0	17	13	S-8	10.5	DENSE	TAN	DECOMPOSED SANDY SHALE	GM	* > 4.5 TSF
14.2	15	15	S-9		↓	↓	↓	↓	
14.7	21	20	S-10	14.2	V. DENSE	DR BROWN	DECOMPOSED SANDSTONE FRAGMENTS	SM	
				14.7	SOFT	LT BROWN	HIGHLY WEATHERED SHALE SANDSTONE / SANDY SHALE HEAVILY STAINED	VA-BR	HEAVILY STAINED VERTICAL FRACTURE 14.3-14.5, 17.5-17.7, 18.2-18.3
	7.8	7.8	100%	19.3	↓	↓	↓	↓	STAINED 37 FRACTURE 17.8, 18.5, 18.9, 19.1, 19.2
				22.0	M. HARD	BROWN	SANDSTONE : STAINED TO ~ 22.2'		17.1, 17.6
				22.8	↓	GRAY	↓	↓	
				24.2	M. SOFT	GRAY	SILTSTONE STAINED 23.85-24.25	BR	LOW & STAINED FRACTURE 24.1, 24.5
					M. SOFT TO SOFT	DK GRAY	CLAYSTONE w/ CALCAREOUS CHASTS + STRINGERS : SANDY 25.8-26.25	BR	LOW & STAINED FRACTURE 25.4, 26.6
	10.0	10.0	100%	28.2	↓	↓	↓	↓	LOW & FRACTURE 27.0
					M. SOFT	GRAY	INTERBEDDED SANDY SHALE AND SILTSTONE	BR	27.8

REMARKS ** DRIILLED BY TORRA TESTIX USING A SIMCO 4000-TL TRACK MOUNTED DRILL
 BORING ADVANCED USING 5/4" SOLID STEM AUGERS, 1" S.D. STEEL CASING, N2-2 WIRELINE COILING TOOLS

* POCKET PENETROMETER READINGS
 ** METHOD OF ADVANCING AND CLEANING BORING

PROJECT AREA 23 JOHN E. AMOS POWER PLANT ST. ALBANS, WV BORING NO. B-0514
 ELEVATION _____ GWL 0 HRS 32.1 PROJECT NO. C04138410-01
 DATE 09-10 MAY 2005 CLASSIFIED BY DAN SANGER PAGE 2 of 5

DEPTH (FT.)	BLOWS PER SIX INCHES OR CORE RECOVERY/RUN	CORE RECOVERY/RUN SAMPLE NO., TYPE & RECOVERY OR % ROCK RECOVERY	RQD (%) OR TORVANE	DESCRIPTION				USCS OR ROCK BROKENNESS	REMARKS*	
				PROFILE	SOIL DENSITY - CONSISTENCY OR ROCK HARDNESS	COLOR	MATERIAL CLASSIFICATION			
1	2	3	4	5	6	7	8	9	10	
32.0	◆			34.8	M. SOFT	GRAY	SHALE/SILTSTONE (LINT)	BR	LOW 3 FRACTURES 29.5, 31.0, 31.15, 32.9, 33.45, 34.5	
					↓	↓	↓	↓		
	10.0	11.0	100%	52	SOFT	MAROON	CLAYSTONE	BR	~30° FRACTURES w/ SLICKENSIDES 35.8, 37.8, 39.2, 39.8, 40.7, 41.15, 41.35	
42.0	◆			42.0	N			↓		
					M. SOFT TO M. HARD	GRAY	INTERBEDDED SANDY SHALE AND SILTSTONE	BR-GL		
	10.0	10.0	100%	89	47.0	↓	↓	↓		
					M. HARD	LT GRAY	SANDSTONE	GL		
52.0	◆				↓	↓	↓	↓		
	10.0	10.0	100%	97	57.9	↓	↓	↓		
					59.3	M. SOFT	GRAY	SILTY SHALE	BR	~30° FRACTURES 57.9,
					↓	DK. GRAY	CLAYSTONE, SLIGHTLY CALCARAEUS	UBA-BA	58.4	

REMARKS ** _____

* POCKET PENETROMETER READINGS
 ** METHOD OF ADVANCING AND CLEANING BORING

PROJECT AREA 2/3, JOHN E. AMOS POWER PLANT ST. ALBANS, WV BORING NO. B-0514
 ELEVATION _____ GWL 0 HRS 22.1 PROJECT NO. C040384.40-01
 DATE 09-13 MAY 2005 CLASSIFIED BY DAN SANGER PAGE 3 of 5

DEPTH (FT.)	BLOWS PER SIX INCHES OR CORE RECOVERY/RUN	CORE RECOVERY/RUN SAMPLE NO., TYPE & RECOVERY OR % ROCK RECOVERY	RQD (%) OR TORVANE	DESCRIPTION				USCS OR ROCK BROKENNESS	REMARKS*
				PROFILE	SOIL DENSITY - CONSISTENCY OR ROCK HARDNESS	COLOR	MATERIAL CLASSIFICATION		
1	2	3	4	5	6	7	8	9	10
62.0	◆				M. SOFT	GRAY + MAROON	CLAYSTONE (CONT)	BR	LOW # FRACTURES 59.5, 59.9, 60.4, 61.2 45° FRACTURE SLICKENSIDES 62.1-62.25 30° FRACTURES 62.6
		100	100	86	66.7	↓	↓	↓	62.7, 62.8, 63.0, 63.4
					M. SOFT TO GRAY		SANDY SHALE/SILTSTONE w/	BL	63.5, 64.1, 64.4,
					M. HARD		NUMEROUS IRREGULAR CALCAREOUS CLASTS AND STRINGERS		65.25, 65.5, 65.75 66.1, 66.5
72.0	◆						MAROON CLAYSTONE		SLICKENSIDES 71.4, 72.0
							71.25-71.55, 72.0-72.4		
		100	100	92	76.0	↓	↓	↓	
					M. SOFT	MAROON	CLAYSTONE w/ NUMEROUS IR-	BR	
							REGULAR CALCAREOUS CLASTS AND STRINGERS		
						GRAY + MAROON MOTTLED			
82.0	◆				82.2	↓	↓	↓	
					M. SOFT TO M. HARD	GRAY	SILTY SHALE w/ INTERMITTENT CALCAREOUS STRINGERS, SOME THIN (≤ 2") SANDSTONES	BL	
		100	100	90				↓	VERTICAL FRACTURE 86.6-87.6
								BL	

REMARKS** _____

* POCKET PENETROMETER READINGS
 ** METHOD OF ADVANCING AND CLEANING BORING

PROJECT AREA 2/3 JOHN E. AMOS POWER PLANT ST. ALBANS, WV BORING NO. B-0514
 ELEVATION _____ GWL 0 HRS 32.1 PROJECT NO. C040384.40-01
 DATE 09-10 MAY 2005 CLASSIFIED BY DAN SANGER PAGE 4 of 5

DEPTH (FT.)	BLOWS PER SIX INCHES OR CORE RECOVERY/RUN	CORE RECOVERY/RUN SAMPLE NO., TYPE & RECOVERY OR % ROCK RECOVERY	RQD (%) OR TORVANE	DESCRIPTION				USCS OR ROCK BROKENNESS	REMARKS*
				PROFILE	SOIL DENSITY - CONSISTENCY OR ROCK HARDNESS	COLOR	MATERIAL CLASSIFICATION		
1	2	3	4	5	6	7	8	9	10
				92.65	M. HARD	LT. GRAY	SANDSTONE	BL	
92.0	◆			93.0	↓	↓	↓	↓	
					M. SOFT	GRAY	SILTY TO SANDY SHALE	BL	
	19.0	10.0	100%	95					
							CLAY SHALE 98.4-99.0	BR	LOW # FRACTURES 98.4,
								BL	98.6, 98.95
102.0	◆					MARSHY + GRAY MOTTLED			SUCKERSIDE 102.0
				104.3	↓	↓	↓	↓	111.0 (~45°)
					M. HARD	LT. GRAY	SANDSTONE	BL	
	10.0	10.0	100%	98					
112.0	◆								
	10.0	10.0	100%	73					

REMARKS ** _____

PROJECT AREA 2/3 JOHN E. AMOS POWER PLANT ST. ALBANS, VT BORING NO. B-0514
 ELEVATION _____ GWL 0 HRS 32.1 PROJECT NO. C040384.40-01
 DATE 29-10 MAY 2005 CLASSIFIED BY DAN SANGER PAGE 5 of 5

DEPTH (FT.)	BLOWS PER SIX INCHES OR CORE RECOVERY/RUN	CORE RECOVERY/RUN SAMPLE NO., TYPE & RECOVERY OR % ROCK RECOVERY	RQD (%) OR TORVANE	DESCRIPTION				USCS OR ROCK BROKENNESS	REMARKS*
				PROFILE	SOIL DENSITY - CONSISTENCY OR ROCK HARDNESS	COLOR	MATERIAL CLASSIFICATION		
1	2	3	4	5	6	7	8	9	10
122.0	◆				M. HARD	LT GRAY	SANDSTONE: MICACEOUS (CONT)	BL	
	10.0	10.0	100%	100					
132.0	◆								
	10.0	10.0	100%	100					
142.0	◆								
				143.2	↓	↓	↓	↓	
					M. SOFT	DK GRAY	CLAY SHALE	BR-BL	
	8.0	8.0	100%	87					~30° FRACTURE 7/8" CLK 143.7, 146.3, 148.8 LOW 3/4 FRACTURE 149.3
150.0	▲								

BOTTOM OF BORING: 150.0'

REMARKS ** _____

* POCKET PENETROMETER READINGS
 ** METHOD OF ADVANCING AND CLEANING BORING

N 539572.1065
E 1723680.1660 Grade El. 933.64



PROJECT AREA 2/3 JOHN E. AMOS POWER PLANT ST. ALBANS, VT BORING NO. B-0515
ELEVATION _____ GWL 0 HRS 42.3 PROJECT NO. C040384.40-01
DATE 10-11 MAY 2005 CLASSIFIED BY DAN SANGER PAGE 1 of 9

DEPTH (FT.)	BLOWS PER SIX INCHES OR CORE RECOVERY/RUN	CORE RECOVERY/RUN SAMPLE NO., TYPE & RECOVERY OR % ROCK RECOVERY	RQD (%) OR TORVANE	DESCRIPTION				USCS OR ROCK BROKENNESS	REMARKS
				PROFILE	SOIL DENSITY - CONSISTENCY OR ROCK HARDNESS	COLOR	MATERIAL CLASSIFICATION		
1	2	3	4	5	6	7	8	9	10
1.5	13	S-1 REC 1.3 S-2			STIFF	ORANGE-BROWN	SANDY CLAY	CI	1.5 TSF
3.0	5	REC 1.3			V. STIFF	BROWN GRAY	SANDY CLAY	CI	2.5 TSF DR
4.5	7	S-3 REC 1.2			DENSE	BROWN	DECOMPOSED SANDSTONE FRAGMENTS		
5.4	16	S-4 REC 0.9		5.4	V. DENSE	BROWN GRAY	DECOMPOSED SANDSTONE AND SANDY CLAY	RC	TOP OF ROCK 5.4
	30/2.4			6.5	SOFT	BROWN	HIGHLY WEATHERED SANDSTONE	VBA-BR	
	3.6	4.9	73%	40	M. SOFT TO M. HARD	BROWN GRAY	MODERATELY WEATHERED SANDSTONE	BR	
10.3				8.8	SOFT	MARBLE TAN	CLAYSTONE: HIGHLY WEATHERED	VBR	~30° FRACTURE 10.5, 11.0, 11.4, 13.9
	100	100	100%	65				BL	
				17.3	M. SOFT TO SOFT	OLIVE GRAY	CLAY SHALE: MODERATELY TO HIGHLY WEATHERED	BR	LOW STRENGTH
20.3				21.0					HEAVY WEATHERED
				22.2	M. SOFT		SILTY SHALE	BR	FRACTURE 22.2, 17.3
	10.0	10.0	100%	83	M. SOFT TO M. HARD	OLIVE GRAY	SILTY SANDSTONE: MEDIUM	BL	
						GRAY			

REMARKS ** DRILLED BY TERRA TESTING USING A SIMCO 1000-T2 TRACK MOUNTED DRILL
BORING ADVANCED USING 5/8" SOLID STEEL AUGERS, 4" STEEL CASING, NO. 2 WIRELINE COILING TOOLS

* POCKET PENETROMETER READINGS
** METHOD OF ADVANCING AND CLEANING BORING
BORING NO. B-0515
(24)

PROJECT RAEY²/7 JOHN E. AMOS POWER PLANT ST. ALBANS, VT

BORING NO. B-0515

ELEVATION _____ GWL 0 HRS 12.3

PROJECT NO. 2040384.11-01

HRS _____

DATE 12-1 MAY 2005

CLASSIFIED BY DAN SANDLER

PAGE 2 of 9

DEPTH (FT.)	BLOWS PER SIX INCHES OR CORE RECOVERY/RUN	CORE RECOVERY/RUN SAMPLE NO., TYPE & RECOVERY OR % ROCK RECOVERY	ROD (%) OR TORVANE	DESCRIPTION				USCS OR ROCK BROKENNESS	REMARKS*
				PROFILE	SOIL DENSITY - CONSISTENCY OR ROCK HARDNESS	COLOR	MATERIAL CLASSIFICATION		
1	2	3	4	5	6	7	8	9	10
30.3	◆						SANDSTONE (CONT)		~65° STAINED FRACTURE
				32.1	↓	↓	↓	↓	30.6-31.0, LOST WATER
				34.3	SOFT	GRAY + MAROON	INTERBEDDED CLAY SHALE AND CLAYSTONE: HIGHLY WEATHERED	UBR	1.2W & FRACTURES
								BR	32.2, 32.5, 31.9, 33.05
	8.8	100	88%	51	20 FT	GRAY + MAROON	CLAYSTONE	BR	34.0, 34.3, 35.1
40.3	◆			40.8					
				42.6	M. SOFT TO M. HARD	GRAY	SANDY SILTSTONE	BR	VERTICAL FRACTURE 41.1-42.6
					M. SOFT	GRAY	CLAYSTONE w/ INTERMITTENT IRREGULAR CALCAREOUS NODULES AND STRINGERS	BR	~25-30° FRACTURE w/ SLICEN SIDES 43.15, 44.55, 45.45, 47.4, 47.75, 48.6, 49.85, 53.5
	10.0	10.0	100%	63					
						MAROON			
50.3	◆			53.7		GRAY	: BECOMES SANDY AT 50.1		
					M. SOFT	GRAY	SANDY SHALE: INTERMITTENT SMALL (≤ 2mm) CALCAREOUS NODULES	BR	
						MAROON			
						GRAY			

REMARKS ** _____

* POCKET PENETROMETER READINGS

** METHOD OF ADVANCING AND CLEANING BORING

PROJECT AREA 2/3, JOHN E. AMOS POWER PLANT ST ALBANS, WV BORING NO. B-0515
 ELEVATION _____ GWL 0 HRS 42.3 PROJECT NO. C040384.40-01
 DATE 10-11 MAY 2005 CLASSIFIED BY DAN SANGER PAGE 3 of 9

DEPTH (FT.)	BLOWS PER SIX INCHES OR CORE RECOVERY/RUN	CORE RECOVERY/TYPE & SAMPLE NO., TYPE & RECOVERY OR % ROCK RECOVERY	RQD (%) OR TORVANE	DESCRIPTION				USCS OR ROCK BROKENNESS	REMARKS*
				PROFILE	SOIL DENSITY - CONSISTENCY OR ROCK HARDNESS	COLOR	MATERIAL CLASSIFICATION		
1	2	3	4	5	6	7	8	9	10
60.3	◆						SANDY SHALE (CONT)		LOW # FRACTURES 63.0, 63.4, 68.0 (SLIGHT SLICKENSIDE) 68.6 VERTICAL FRACTURE 69.1- 69.6, 70.3-70.7, 70.85-71.05, 74.8- 75.1, 76.25-77.4
		10.0	10.0	100%	86				
70.3	◆								LOW # FRACTURE 72.7, 79.4, 79.45, 80.05
		10.0	10.0	100%	80				
80.3	◆								
					83.5	SOFT	ORGANIC CLAYSTONE		PITTED CORE SURFACE. LOW # FRACTURES ^W /SLICKEN- SIDES 83.6, 83.95, 84.2, 84.55, 84.7, 85.0, 85.45
		9.2	10.0	92%	72				
					87.7	M-SOFT	GRAY SANDY SHALE	BR-BL	HIGH # FRACTURE ^W /SLICKEN- SIDES 86.2-86.35

REMARKS ** _____

* POCKET PENETROMETER READINGS
 ** METHOD OF ADVANCING AND CLEANING BORING

PROJECT AREA 2/3 JOHN E. AMOS POWER PLANT ST. ALBANS, WV BORING NO. B-0515
 ELEVATION _____ GWL 0 HRS 42.3 PROJECT NO. CA038420-01
 DATE 10-11 MAY 2005 CLASSIFIED BY DAN SANGER PAGE 41 of 9

DEPTH (FT.)	BLOWS PER SIX INCHES OR CORE RECOVERY/RUN	SAMPLE NO., TYPE & RECOVERY OR % ROCK RECOVERY	ROD (%) OR TORVANE	DESCRIPTION					USCS OR ROCK BROKENNESS	REMARKS*
				PROFILE	SOIL DENSITY - CONSISTENCY OR ROCK HARDNESS	COLOR	MATERIAL CLASSIFICATION			
1	2	3	4	5	6	7	8		9	10
90.3	◆			90.5	SOFT TO M. SOFT		GRAY CLAY SHALE		BL-BL	NEAR VERTICAL
										IRREGULAR FRACTURE WITH SPICES 91.65 -
				94.4						92.05 (NO STAINING)
	10.0	10.0	100%	75	M. SOFT TO M. HARD		LT. GRAY SHALY SANDSTONE MICACEOUS		BR -	VERTICAL FRACTURE
									BL	92.4-92.8, 93.35-93.85
									BL	
100.3	◆									
	10.0	10.0	100%	100						
110.3	◆									
										SHALE CLASTS 112.5-113.4
	10.0	10.0	100%	90						
				117.0						
					SOFT TO M. SOFT		GRAY CLAY SHALE		BR	V. BROKEN 118.4-119.1
										HIGH % FRACTURE 119.0-119.2

REMARKS ** _____

* POCKET PENETROMETER READINGS
 ** METHOD OF ADVANCING AND CLEANING BORING

PROJECT AREA 2/3 JOHN E. AMOS POWER PLANT ST. ALBANS, WV BORING NO. B-0515
 ELEVATION _____ GWL 0 HRS 42.3 PROJECT NO. C040384.40-01
 DATE 10-11 MAY 2005 CLASSIFIED BY DAN SANGER PAGE 5 of 9

DEPTH (FT.)	BLOWS PER SIX INCHES OR CORE RECOVERY/RUN	CORE RECOVERY/RUN SAMPLE NO., TYPE & RECOVERY OR % ROCK RECOVERY	RQD (%) OR TORVANE	PROFILE	DESCRIPTION			USCS OR ROCK BROKENNESS	REMARKS*
					SOIL DENSITY - CONSISTENCY OR ROCK HARDNESS	COLOR	MATERIAL CLASSIFICATION		
1	2	3	4	5	6	7	8	9	10
120.3	◆			120.5	M. SOFT	GRAY	SANDY SHALE	BR	
				122.6					
					M. SOFT TO M. HARD	LT GRAY	SHALY SANDSTONE; MICACEOUS	BR	
	10.0	10.0	100%	125.55	M. SOFT TO SOFT	GRAY + MAROON MOTTLED	CLAYSTONE	BR	45° SLICKENSIDES 126.9-127.05. PIECES ~0.2-0.4'
			64						
130.3	◆							VBL	LOW & FRACTURE EVERY 0.1-0.85'
									25-30° SLICKENSIDES 131.1, 131.25, 131.3 131.75
	10.0	10.0	100%	132		MAROON			V. BROKEN ZONE 131.75-137.1: NUMEROUS ~30° SLICKENSIDES PIECES 0.1-0.3'
				138.5					CALCAREOUS NOBULES
140.3	◆				M. SOFT	GRAY	SHALE WITH NUMEROUS IRREGULAR CALCAREOUS NOBULES AND STRINGERS	BR-BSL	137.2-138.0
	10.0	10.0	100%	9.1			SANDY 148.3-148.6, 149.35-150.15		

REMARKS ** _____

* POCKET PENETROMETER READINGS
 ** METHOD OF ADVANCING AND CLEANING BORING

PROJECT AREA 2/3 JOHN E. AMOS POWER PLANT

BORING NO. B-0515

ELEVATION _____ GWL 0 HRS 42.3

PROJECT NO. C04038441-01

HRS _____

DATE 10-11 MAY 2005 CLASSIFIED BY DAN SANGER

PAGE 6 of 9

DEPTH (FT.)	BLOWS PER SIX INCHES OR CORE RECOVERY/RUN	SAMPLE NO., TYPE & RECOVERY OR % ROCK RECOVERY	RQD (%) OR TORVANE	DESCRIPTION				USCS OR ROCK BROKENNESS	REMARKS*
				PROFILE	SOIL DENSITY - CONSISTENCY OR ROCK HARDNESS	COLOR	MATERIAL CLASSIFICATION		
1	2	3	4	5	6	7	8	9	10
150.3	◆						SHALE (CONT)		
							= SANDY 154.6 - 155.7		60° IRREGULAR
							157.0 - 160.2 (FAN		FRACTURE 155.2 - 155.5
	100	10.0	100%	88			MODULES)		
160.3	◆								
				161.0	M. SOFT	GRAY + PURPLE	CLAYSTONE	BA-	20-30° SLICKENSIDES
								UBA	161.4, 161.8, 162.2,
				164.7					163.2, 163.35, 163.65
									164.0, 164.1
	10.0	10.0	100%	77	M. SOFT	GRAY	SANDY SHALE	BA-BL	
170.3	◆								
				171.7	M. HARD	LT GRAY	SANDSTONE - MICACEOUS	BL	
				174.8	M. SOFT	GRAY	SANDY SHALE	BL	
	10.0	10.0	100%	100					

REMARKS ** _____

* POCKET PENETROMETER READINGS
** METHOD OF ADVANCING AND CLEANING BORING

PROJECT AREA 2/3 JOHN E. AMOS POWER PLANT

 BORING NO. B-0515

 ELEVATION _____ GWL 0 HRS 42.3

 PROJECT NO. C040384.40-01

 DATE 10-11 MAY 2005

 CLASSIFIED BY DAN SANGER

 PAGE 7 of 9

DEPTH (FT.)	BLOWS PER SIX INCHES OR CORE RECOVERY/RUN	SAMPLE NO., TYPE & RECOVERY OR % ROCK RECOVERY	RQD (%) OR TORVANE	DESCRIPTION				USCS OR ROCK BROKENNESS	REMARKS*
				PROFILE	SOIL DENSITY - CONSISTENCY OR ROCK HARDNESS	COLOR	MATERIAL CLASSIFICATION		
1	2	3	4	5	6	7	8	9	10
180.3	◇						SANDY SHALE (CONT)		
				184.0	SOFT TO M. SOFT	DK GRAY	CLAY STONE	VBR - BR	~30° SLICKEN SIDES EVERY 0.2 - 0.4'
	10.0	10.0	100%			MAROON			
190.3	◇			190.3	M. SOFT	GRAY + MAROON	SILTY TO SANDY SHALE	BL - BR	LOW % FRACTURE 194.1, 194.3, 195.0, 196.05, 196.4, 196.9 197.6, 197.9
	10.0	10.0	100%						
				197.0	SOFT TO M. SOFT	MAROON	CLAY STONE	BA - VBR	30° FRACTURE 196.15 30° SLICKEN SIDES ~ EVERY 0.4'
200.3	◇			200.5	M. SOFT	MAROON	SILTY SHALE	BL	GRADES INTO SILTY SHALE
	10.0	10.0	100%						
				206.55	M. SOFT TO M. HARD	GRAY	SHALY SANDSTONE	BR	
					M. HARD	LT GRAY	SANDSTONE	BR	

REMARKS **

 * POCKET PENETROMETER READINGS
 ** METHOD OF ADVANCING AND CLEANING BORING

PROJECT AREA 2/3 JOHN E: AMOS POWER PLANT ST. ALBANS, WV BORING NO. B-0515
 ELEVATION _____ GWL 0 HRS 423 PROJECT NO. C040384.4001
 DATE 10-11 MAY 2005 CLASSIFIED BY DAN SANGER PAGE 8 of 9

DEPTH (FT.)	BLOWS PER SIX INCHES OR CORE RECOVERY/RUN	CORE RECOVERY/TYPE & RECOVERY OR % ROCK RECOVERY	RQD (%) OR TORVANE	DESCRIPTION				USCS OR ROCK BROKENNESS	REMARKS*
				PROFILE	SOIL DENSITY - CONSISTENCY OR ROCK HARDNESS	COLOR	MATERIAL CLASSIFICATION		
1	2	3	4	5	6	7	8	9	10
210.3	◆			210.3	M. SOFT	GRAY	SANDY SHALE	BR	
				212.4	M. HARD	↓	↓	↓	
				214.3	M. SOFT	MAROON	SILTY SHALE	BR	
	10.0	10.0	100%	88	M. SOFT	BROWN, MAROON, GRAY MOTTLED	CLAYSTONE	BR	25-30° SLICKENSIDES 215.0, 215.20, 215.55 216.15, 217.85, 218.15 60° SLICKENSIDE 215.3- 215.45
				218.8	↓	↓	↓	↓	
220.3	◆			220.3	M. HARD	LT GRAY	SHALY SANDSTONE	BR	
				221.5	M. SOFT	GRAY	SANDY CLAYSTONE	BR	
				223.5	↓	↓	↓	↓	30° SLICKENSIDE 123.1
	10.0	10.0	100%	90	M. SOFT	GRAY	SANDY SHALE	BR-BL	LOW # FRACTURES 125.55, 125.8
				227.7	↓	↓	↓	↓	
230.3	◆			230.3	M. SOFT TO SOFT	GRAY, OLIVE, MAROON MOTTLED	CLAYSTONE	BR	20-30° SLICKENSIDES 229.9, 231.4, 231.5 232.2, 232.4, 232.5 233.0, 233.2, 233.8 234.4, 235.6, 236.1 236.4, 237.5, 237.9, 238.9, 239.1, 239.6 239.8, 240.1
	10.0	10.0	100%	56	↓	↓	↓	↓	

REMARKS **

* POCKET PENETROMETER READINGS
 ** METHOD OF ADVANCING AND CLEANING BORING

PROJECT AREA 2/3 JOHN E. AMOS POWER PLANT ST. ALBANS, WV BORING NO. B-0515
 ELEVATION _____ GWL 0 HRS 42.3 PROJECT NO. C040384.40-01
 DATE 10-11 MAY 2005 CLASSIFIED BY DAN SANGER PAGE 9 of 9

DEPTH (FT.)	BLOWS PER SIX INCHES OR CORE RECOVERY/RUN	SAMPLE NO., TYPE & RECOVERY OR % ROCK RECOVERY	RQD (%) OR TORVANE	PROFILE	DESCRIPTION			USCS OR ROCK BROKENNESS	REMARKS*
					SOIL DENSITY - CONSISTENCY OR ROCK HARDNESS	COLOR	MATERIAL CLASSIFICATION		
1	2	3	4	5	6	7	8	9	10
240.3	◆				SOFT	MARON	CLAYSTONE (CONT)	VBR	20-30 SLICKENSIDES EVERY 0.1-0.3'
	10.0	10.0	100%	0					
250.3	▲								
							BOTTOM OF BORING: 250.3'		

REMARKS** _____

* POCKET PENETROMETER READINGS
 ** METHOD OF ADVANCING AND CLEANING BORING

N 540842.6369
E 1724930.8565

Grade El. 864.94



PROJECT AREA 2/3 JOHN E. AMOS POWER PLANT ST. ALBANS, WV BORING NO. B-0516
 ELEVATION _____ GWL 0 HRS N/A PROJECT NO. C040384.40-01
 DATE 13 MAY 2005 CLASSIFIED BY DAN SANGER PAGE 1 of 1

DEPTH (FT.)	BLOWS PER SIX INCHES OR CORE RECOVERY/RUN	CORE RECOVERY/TYPE & SAMPLE NO., TYPE & RECOVERY OR % ROCK RECOVERY	ROD (%) OR TORVANE	PROFILE	DESCRIPTION			USCS OR ROCK BROKENNESS	REMARKS*
					SOIL DENSITY - CONSISTENCY OR ROCK HARDNESS	COLOR	MATERIAL CLASSIFICATION		
1	2	3	4	5	6	7	8	9	10
1.5	44	S-1 REC 1.5			LOOSE	BROWN	SANDY SILT, FEW ROCK FRAGMENTS	ml	DRY
3.0	7	S-2 REC. 1.2			M. DENSE	GRANITE FRAGMENTS	SILTY SAND AND ROCK FRAGMENTS; DECOMPOSED CLAYSTONE	SM-GM	DRY
3.9	24	S-3 REC. 0.9		3.9 FILE					
							BRING CANCELLED AND BACK FILLED		

REMARKS ** DRILLED BY TERLA TESTING, INC USING A SIMCO 4000-T2 TRACK MOUNTED DRILL.
BORING ADVANCED USING 5/4" SOLID STEEL AUGERS

* POCKET PENETROMETER READINGS
 ** METHOD OF ADVANCING AND CLEANING BORING

BORING NO. B-0516
(23)

N 542185.2965
E 1725391.3276

Grade El. 945.55



PROJECT AREA 2/3 JOHN E. AMOS POWER PLANT ST. ALBANS, WV

BORING NO. B-0517

ELEVATION 948± GWL 0 HRS 18.1

PROJECT NO. C040384.40-01

DATE 16-17 MAY 2005

CLASSIFIED BY DAN SANGER

PAGE 1 of 5

DEPTH (FT.)	BLOWS PER SIX INCHES OR CORE RECOVERY/RUN	CORE RECOVERY/RUN SAMPLE NO., TYPE & RECOVERY OR % ROCK RECOVERY	RQD (%) OR TORVANE	DESCRIPTION				USCS OR ROCK BROKENNESS	REMARKS*
				PROFILE	SOIL DENSITY - CONSISTENCY OR ROCK HARDNESS	COLOR	MATERIAL CLASSIFICATION		
1	3	S-1							
1.5	3	REC. 1.5		8.0	V. STIFF	MAROON-RED	SILTY TO SANDY CLAY (DECOMPOSED CLAYSTONE)	CI	* 2.5 TSP
3.0	5	REC. 0.8			STIFF				* 1.5 TSP
4.5	6	S-3			HARD		DECOMPOSED CLAYSTONE, TRACE CALCAREOUS NODULES		24.5 TSP
6.0	19	REC. 1.2							
7.5	20	S-5							
9.0	25	REC. 1.5			V. DENSE	YELLOW GRAY	DECOMPOSED SANDY SHALE	SM	
9.9	28	S-7		9.9					
11.1	20	95%	81	11.1	M. SOFT	OLIVE	SANDY SHALE	BR	
12.0	21				M. HARD	GRAY	SANDSTONE	BR	
				12.9					
					M. SOFT	OLIVE-GRAY	INTER-BEDDED SANDY SHALE AND SHALY SANDSTONE	BR-	
									STAINED ~60° FRACTURE
10.0	10.0	100%	74						13.45-13.6, 19.05-19.3, 19.7-19.9, 20.2-20.5
									LOW & FRACTURES 14.3, 15.25, 15.4, 15.65, 16.9, 19.3, 20.1, 20.65
22.0									STAINED V. BROKEN ZONE 19.7-19.7
				24.7					
					SOFT	MAROON	CLAYSTONE	BR-	STAINED LOW & FRAC -
9.9	10.0	99%	84	27.1					TUNES 22.35, 23.45, 23.9, 24.15, 24.25, 25.0
					M. SOFT TO M. HARD	OLIVE-GRAY	SHALY SANDSTONE - MICACEOUS	BA- BL	NBA 25.7-26.2

REMARKS ** DRILLED BY TERRATESTING USING A SIMCO 400D-T2 TRACK MOUNTED DRILL
BORING ADVANCED USING 5/4" SOLID STEM AUGERS, 4" STEEL CASING, HQ-2 WIRELINE CORING TOOLS

* POCKET PENETROMETER READINGS
** METHOD OF ADVANCING AND CLEANING BORING

PROJECT AREA 2/3, JOHN E. AMOS POWER PLANT ST. ALBANS, WV BORING NO. B0517
 ELEVATION 948± GWL 0 HRS 18.1 PROJECT NO. C040884.40-01
 DATE 16-17 MAY 2005 CLASSIFIED BY DAN SANGER PAGE 2 of 5

DEPTH (FT.)	BLOWS PER SIX INCHES OR CORE RECOVERY/RUN	CORE RECOVERY/RUN SAMPLE NO., TYPE & RECOVERY OR % ROCK RECOVERY	RQD (%) OR TORVANE	DESCRIPTION				USCS OR ROCK BROKENNESS	REMARKS*
				PROFILE	SOIL DENSITY - CONSISTENCY OR ROCK HARDNESS	COLOR	MATERIAL CLASSIFICATION		
1	2	3	4	5	6	7	8	9	10
32.0	◆				M. HARD	GRAY	SANDSTONE (COH'G)		
									STAINED LOW & FRAC-TURES 32.3, 34.15
				36.2	SOFT	MAYWOOD	CLAYSTONE	BR	20-30° SLICKENSIDES
	10.0	10.0	100%	82					36.7, 37.4, 37.8, 38.4
				40.5				VBR	38.8, 38.95, 39.2
42.0	◆				M. MFT	GRAY	INTERBEDDED SHALE AND SANDSTONE	BR	
									44.6 CLAY SEAM
	9.6	10.0	96%	96					
				47.6	M. HARD	LT. GRAY	SANDSTONE - FINE TO MED GRAINED, MICACEOUS	BL	
52.0	◆								VERTICAL FRACTURE (NO STAINING) 53.3-54.4
				55.7					
	10.0	10.0	100%	70	M. HARD	LT. GRAY	CALCAREOUS SANDSTONE	BR	LOW # FRACTURES 55.7, 56.2, 56.7, 57.5, 58.1
					SOFT	GRAY	CLAY SHALE, SOME SILT	BR	59.25, 59.55, 59.7, 60.0, 60.25,
				59.7					

REMARKS ** _____

* POCKET PENETROMETER READINGS
 ** METHOD OF ADVANCING AND CLEANING BORING

PROJECT AREA 2/3, JOHNE. AMOS POWER PLANT, ST. ALBANS, WV

BORING NO. B-0517

ELEVATION 948± GWL 0 HRS 18.1

PROJECT NO. C040384/0-01

DATE 16-17 MAY 2005

CLASSIFIED BY DAN SANGER

PAGE 3 of 5

DEPTH (FT.)	BLOWS PER SIX INCHES OR CORE RECOVERY/RUN	SAMPLE NO., TYPE & RECOVERY OR % ROCK RECOVERY	RQD (%) OR TORVANE	DESCRIPTION				USCS OR ROCK BROKENNESS	REMARKS*
				PROFILE	SOIL DENSITY - CONSISTENCY OR ROCK HARDNESS	COLOR	MATERIAL CLASSIFICATION		
1	2	3	4	5	6	7	8	9	10
62.0	◆				SOFT	DARK GRAY MAROON	CLAYSTONE	BR - VBR	25-35° SLICKEN SIDES ~ EVERY 0.2-0.4'
					↓	↓	↓	↓	
	10.0	10.0	100%	67					
					M. HARD	GRAY	SILTSTONE w/ INTERMITTENT IRREGULAR CALCAREOUS NODULES AND STRINGERS, SOME SAND	BL	LW & FRACTURE 70.35, INTERSECTING 45° FRACTURE AND 30° FRACTURE 71.6-71.9 NEAR VERTICAL FRAC - TRACE 72.9-73.4
72.0	◆				↓	↓	↓	↓	
				75.5					
					SOFT	MAROON	CLAYSTONE	BR - VBR	30° SLICKEN SIDES ~ EVERY 0.2-0.3'
	10.0	10.0	100%	79					
					M. SOFT TO M. HARD	GRAY	SANDY SILTSTONE w/ INTERMITTENT IRREGULAR CALCAREOUS NODULES (≤ 1/2") AND STRINGERS	BA-BL	~45° FRACTURE AT LARGE CALC. NODULE AT 78.6-78.8
82.0	◆				↓	↓	↓	↓	
					SOFT TO M. SOFT	MAROON GRAY	INTERBEDDED CLAYSTONE AND SANDY SILTSTONE (WHITS ARE 0.9-1.5" IN THICKNESS) w/ INTERMITTENT IRREGULAR CALCAREOUS NODULES (1/2") AND STRINGERS	BR - BL	SLICKEN SIDES (30°) 82.25
					↓	↓	↓	↓	
	10.0	10.0	100%	97					
					↓	↓	↓	↓	

REMARKS **

* POCKET PENETROMETER READINGS

** METHOD OF ADVANCING AND CLEANING BORING

PROJECT AREA 2/3, JOHN E. AMOS POWER PLANT, ST-ALBANS, WV

BORING NO. B-0517

ELEVATION 948 ± GWL 0 HRS 18.1
HRS _____

PROJECT NO. 040384.40-01

DATE 16-17 MAY 2005 CLASSIFIED BY DAN SANGER

PAGE 4 of 5

DEPTH (FT.)	BLOWS PER SIX INCHES OR CORE RECOVERY/RUN	CORE RECOVERY/RUN SAMPLE NO., TYPE & RECOVERY OR % ROCK RECOVERY	ROD (%) OR TORVANE	PROFILE	DESCRIPTION			USCS OR ROCK BROKENNESS	REMARKS*
					SOIL DENSITY - CONSISTENCY OR ROCK HARDNESS	COLOR	MATERIAL CLASSIFICATION		
1	2	3	4	5	6	7	8	9	10
				90.2	M. HARD	LT GRAY	SHALY SANDSTONE - MICACEOUS	BL-	
92.0	◇								
				97.4	SOFT TO M. SOFT	GRAY MAROON	SILTY SHALE	BA	LOW X FRACTURE 98.15, 98.8, 101.0
	10.0	10.0	100%	90					
102.0	◇			101.8					W FRACTURE 99.1-99.4, 100.0-100.5
				103.0	M. HARD	LT GRAY	SHALY SANDSTONE	↓	
				104.0	M. SOFT	GRAY	SILTSTONE	BL	
	10.0	10.0	100%	94					
				108.7	M. SOFT	GRAY + MAROON	INTERDEDED SILTSTONE AND SANDY CLAYSTONE	↓	30° SLICKENSIDES 106.8
				112.0	M. SOFT TO M. HARD	MAROON BROWN + GRAY	CLAYSTONE W/ INTERMITTENT IRREGULAR CALCAREOUS NODULES (½") AND STRINGERS	BA	20-30° SLICKENSIDES 109.2, 109.85, 110.95, 111.2, 111.45,
112.0	◇								
	10.0	10.0	100%	100					

REMARKS ** _____

* POCKET PENETROMETER READINGS

** METHOD OF ADVANCING AND CLEANING BORING

BORING NO. B-0517

PROJECT AREA 2/3, JOHN E. AMOS POWER PLANT, ST. ALBANS, WV

BORING NO. B-0517

ELEVATION 948± GWL 0 HRS 18.1

PROJECT NO. CD40384.40-01

DATE 16-17 MAY 2005

CLASSIFIED BY DAN SANGER

PAGE 5 of 5

DEPTH (FT.)	BLOWS PER SIX INCHES OR CORE RECOVERY/RUN	SAMPLE NO., TYPE & RECOVERY OR % ROCK RECOVERY	RQD (%) OR TORVANE	DESCRIPTION				USCS OR ROCK BROKENNESS	REMARKS*
				PROFILE	SOIL DENSITY - CONSISTENCY OR ROCK HARDNESS	COLOR	MATERIAL CLASSIFICATION		
1	2	3	4	5	6	7	8	9	10
122.0	◆				M. HARD	GRAY TO LT. GRAY	SANDSTONE (CONT)	BL	
		10.0	10.0	100%					
132.0	◆			132.0	M. SOFT	GRAY	SANDY SHALE	BL	
		10.0	10.0	100%					
				136.0	M. HARD	LT GRAY	SANDSTONE		
				139.0	M. SOFT	GRAY	SANDY SHALE		
				142.0	M. SOFT	LT GRAY	SILTY SANDSTONE		
142.0	◆			142.0	M. SOFT	GRAY	SANDY CLAYSTONE	BR	SLICKEN SIDES
									142.3, 143.65, 144.2,
									144.7, 145.0, 145.15,
		8.0	8.0	100%					145.75. NUMEROUS BREAKS DURING CORE EXTRACTION
				146.0	M. SOFT	GRAY	SILTSTONE	BL	CALCAREOUS FODDLES
									146.0-146.2
150.0	▲						BOTTOM OF BORING: 150'		

REMARKS **

* POCKET PENETROMETER READINGS
** METHOD OF ADVANCING AND CLEANING BORING

N 541508.473
E 1724947.2614

Grade El. 1015.78



PROJECT AREA 2/3 JOHN E. AMOS POWER PLANT

BORING NO. B-0518

ELEVATION 1005± GWL 0 HRS 14.2, BACKFILLED

PROJECT NO. C040384.40-01

DATE 17 MAY 2005

HRS _____ CLASSIFIED BY DAN SANGER

PAGE 1 of 3

DEPTH (FT.)	BLOWS PER SIX INCHES OR CORE RECOVERY/RUN	CORE RECOVERY/RUN SAMPLE NO., TYPE & RECOVERY OR % ROCK RECOVERY	RQD (%) OR TORVANE	PROFILE	DESCRIPTION			USCS OR ROCK BROKENNESS	REMARKS*
					SOIL DENSITY - CONSISTENCY OR ROCK HARDNESS	COLOR	MATERIAL CLASSIFICATION		
1	2	3	4	5	6	7	8	9	10
1.5	2	S-1			LOOSE	BROWN	FINE TO MEDIUM SAND	SP	
3.0	8	REC 1.4 S-2			M. DENSE V. DENSE				
3.6	50	REC 1.3 S-3 REC 0.6		3.6					TOP OF ROCK: 3.6'
5.0	7.2	69%	0		SOFT	YELLOW BROWN	SANDSTONE: MICACEOUS, COMPLETELY WEATHERED	VBR	AFTER THIS RUN, DROVE CASING TO 10.2'
10.8									
	9.4	10.0	94%	46			HIGHLY WEATHERED	BR	PIECES 0.3-0.6'
							COMPLETELY WEATHERED	VBR	PIECES ≤ 0.2'
20.8									
	6.8	10.0	68%	18					

REMARKS ** DRILLED BY TERRA TESTING, INC. USING A SIMCO 4000-T2 TRACK MOUNTED DRILL

BORING ADVANCED USING 5/8" SOLID STEM AUGER; 4" STEEL CASING, NQ-2 WIRELINE COILING TOOLS

* POCKET PENETROMETER READINGS

** METHOD OF ADVANCING AND CLEANING BORING

BORING NO. B-0518

(29)

PROJECT AREA 2/3 DOWN E. AMOS POWER PLANT ST. ALBANS, VT BORING NO. B-0518
 ELEVATION 1005± GWL 0 HRS 14.2 BACKFILLED PROJECT NO. 2040384.4020
 DATE 17 MAY 2005 CLASSIFIED BY DAN SANGER PAGE 2 of 3

DEPTH (FT.)	BLOWS PER SIX INCHES OR CORE RECOVERY/RUN	SAMPLE NO., TYPE & RECOVERY OR % ROCK RECOVERY	ROD (%) OR TORVANE	PROFILE	DESCRIPTION			USCS OR ROCK BROKENNESS	REMARKS*
					SOIL DENSITY - CONSISTENCY OR ROCK HARDNESS	COLOR	MATERIAL CLASSIFICATION		
1	2	3	4	5	6	7	8	9	10
30.8	◆				SOFT	YELLOW-BROWN	SANDSTONE (CONT)	UBR	
							HIGHLY WEATHERED	BR	70° STAINED FRACTURE 30.8-31.3
	10.9	100	100%	39					
				36.8					
				39.0	M. SOFT	BROWN	SANDY TO SILTY SHALE	BR	30° STAINED /
									FRACTURES 37.6,
					SOFT	GRAY	CLAYSTONE	BR	38.6, 39.0
40.8	◆					MAROON, PURPLE, YELLOW, GRAY			SLICKEN SIDES: 41.05,
									41.3, 41.7, 42.9, 43.5,
									44.9, 45.15, 45.85,
									46.5, 47.3, 47.95,
	10.0	10.0	100%	64					48.15, 49.25, 49.8,
									50.15, 50.45, 50.8,
									51.1, 51.4, 51.8, 52.2,
									52.75, 53.15, 53.7
									54.2
50.8	◆								
	9.5	10.0	95%	64					
								UBR	VERTICAL FRACTURE 56.4-58.7

REMARKS **

* POCKET PENETROMETER READINGS
 ** METHOD OF ADVANCING AND CLEANING BORING

PROJECT AREA 2/3 JOHN E. AMOS POWER PLANT, ST. ALBANS, VT BORING NO. B-0518
 ELEVATION 1005± GWL 0 HRS 14.2, BACKFILLED PROJECT NO. C040384.40-01
 DATE 17 MAY 2005 CLASSIFIED BY DAN SANGER PAGE 3 of 3

DEPTH (FT.)	BLOWS PER SIX INCHES OR CORE RECOVERY/RUN	CORE RECOVERY/TYPE & RECOVERY OR % ROCK RECOVERY	ROD (%) OR TORVANE	DESCRIPTION				USCS OR ROCK BROKENNESS	REMARKS*
				PROFILE	SOIL DENSITY - CONSISTENCY OR ROCK HARDNESS	COLOR	MATERIAL CLASSIFICATION		
1	2	3	4	5	6	7	8	9	10
60.8	4.2				SFFT	MARBLE, GRAY, PURPLE YELLOW	CLAYSTONE (CONT)	BR-	
				62.8	↓			VBR	
65.0					M. SFFT	GRAY	SANDY SILTSTONE w/ CALCAREOUS NODULES AND STRINGERS	BR-	
				65.0	↓	↓		BL	
							BOTTOM OF BORING: 65'11"		

REMARKS ** _____

* POCKET PENETROMETER READINGS
 ** METHOD OF ADVANCING AND CLEANING BORING

PROJECT AREA 2/3, JOHN E. AMOS POWER PLANT ST. ALBANS, WV BORING NO. B-0519
 ELEVATION _____ GWL 0 HRS 3285 PROJECT NO. C040384.41-01
 DATE 17-19 MAY 2005 CLASSIFIED BY DANSANGER PAGE 1 of 5

DEPTH (FT.)	BLOWS PER SIX INCHES OR CORE RECOVERY/RUN	CORE RECOVERY/TYPE & SAMPLE NO., TYPE & RECOVERY OR % ROCK RECOVERY	ROD (%) OR TORVANE	DESCRIPTION					
				PROFILE	SOIL DENSITY - CONSISTENCY OR ROCK HARDNESS	COLOR	MATERIAL CLASSIFICATION	USCS OR ROCK BROKENNESS	REMARKS*
1	2	S-1		5	6	7	8	9	10
1.5	3	REC. 1.2		0.7	V. LOOSE	BROWN	TOP SOIL		
3.0	6	S-2			LOOSE	BROWN	SANDY SILT	M1	
4.5	7	S-3			M. DENSE		SILT, TRACE CLAY		
6.0	10	REC. 1.3			DENSE	BROWN + GRAY	DECOMPOSED SHALE	gm	
7.4	28	S-5		7.4	V. DENSE				
	3.1	100%	0	7.4	SOFT	BROWN + GRAY	CLAY SHALE: COMPLETELY WEATHERED	NBR	TOP OF ROCK 7.4
10.5									NUMEROUS LOW & FRACTURES
									HIGHLY BROKEN ZONE 8.1-8.7
				13.7					
				14.7	SOFT		CLAYSTONE: COMPLETELY WEATHERED	BR	HIGH FRACTURE 13.7
	9.5	10.0	95%	15.5	M. HARD		SANDSTONE	BR	
					SOFT	MAROON WITH YELLOW MOTTLING	CLAYSTONE: HIGHLY WEATHERED	BR	30° SLICKEN SIDES 18.7, 19.4, 19.85, 23.0, 23.3, 23.6, 23.9, 24.05
20.5					SOFT TO M. SOFT		: SOME CALCAREOUS NODULES		
					M. SOFT	GRAY			45° FRACTURES 22.2
	10.0	10.0	100%	60		GRAY w/ MAROON MOTTLING	: PIECES 0.2-0.4' LONG		STAINED 20-30° FRACTURES 24.7, 25.2, 25.8, 26.0

REMARKS ** DRILLED BY TERAA TESTING USING A SIMCO 4000-T2 TRACK MOUNTED DRILL
 BORING ADVANCED USING 5/4" SOLID STEM AUGERS, 4" STEEL CASING, NQ-2 WIRELINE CORING TOOLS

* POCKET PENETROMETER READINGS
 ** METHOD OF ADVANCING AND CLEANING BORING

PROJECT AAEA 2/3 JOHN E. AMOS POWER PLANT ST ALBANS, WV

BORING NO. B-0519

ELEVATION _____ GWL 0 HRS _____

PROJECT NO. C040384.43-01

HRS _____

DATE 17-19 MAY 2005

CLASSIFIED BY DAN SANGER

PAGE 2 of 5

DEPTH (FT.)	BLOWS PER SIX INCHES OR CORE RECOVERY/RUN	CORE RECOVERY/RUN SAMPLE NO., TYPE & RECOVERY OR % ROCK RECOVERY	ROD (%) OR TORVANE	DESCRIPTION				USCS OR ROCK BROKENNESS	REMARKS*
				PROFILE	SOIL DENSITY - CONSISTENCY OR ROCK HARDNESS	COLOR	MATERIAL CLASSIFICATION		
1	2	3	4	5	6	7	8	9	10
30.5	◆			31.4			CLAYSTONE (CONT)	VBR	
					M. SOFT	OLIVE-GRAY	SANDY SILTSTONE	BR	STAINED LOW & FRACTURE 32.2, 33.0, 33.3
				33.2	↓	↓	↓	↓	34.3, 34.8, 35.1, 35.45
					S. FT TO	GRAY	CLAY SHALE		
				35.1	M. SOFT	↓	↓	↓	
	10.0	10.0	100%	58	36.4	M. SOFT	OLIVE-GRAY	SANDY SILTSTONE	
					SOFT TO	MAROON + GRAY	CLAYSTONE	BR-BL	
					M. SOFT	↓	↓	↓	
40.5	◆			41.5	↓	↓	↓	↓	20° SLICKENSIDE, 40.5
					M. HARD	GRAY	SANDSTONE: MICACEOUS	BR-BL	70° SLICKENSIDE 41.0-41.3
				43.8	↓	↓	↓	↓	NEAR VERTICAL FRACTURE
					M. SOFT	GRAY	SHALY SILTSTONE, SOME SAND	BR	42.85 - 43.8
	10.0	10.0	100%	71	47.4	↓	↓	↓	
					M. SOFT	GRAY	SILTY CLAYSTONE	BR	
					↓	MAROON + DK GRAY	↓	↓	20-30° SLICKENSIDES
50.5	◆								48.65, 49.6, 50.3, 50.8, 52.9, 53.2, 53.5, 54.2, 54.8, 55.3, 55.6, 55.8, 56.0, 56.6, 57.0, 57.4, 57.8, 58.1, 58.4, 59.2
	10.0	10.0	100%	53					

REMARKS ** _____

* POCKET PENETROMETER READINGS
** METHOD OF ADVANCING AND CLEANING BORING

BORING NO. B-0519

PROJECT AREA 2/3 JOHN E. AMOS POWER PLANT ST ALBANS, WV BORING NO. B-0519
 ELEVATION _____ GWL 0 HRS 32.85 PROJECT NO. C040384.43-01
 DATE 17-19 MAY 2005 CLASSIFIED BY DAN SANGER PAGE 3 of 5

DEPTH (FT.)	BLOWS PER SIX INCHES OR CORE RECOVERY/RUN	SAMPLE NO., TYPE & RECOVERY OR % ROCK RECOVERY	RQD (%) OR TORVANE	PROFILE	DESCRIPTION			USCS OR ROCK BROKENNESS	REMARKS*
					SOIL DENSITY - CONSISTENCY OR ROCK HARDNESS	COLOR	MATERIAL CLASSIFICATION		
1	2	3	4	5	6	7	8	9	10
60.5	◆				SOFT to M. SOFT	MAROON	CLAYSTONE (CONT)	BR	20°-30° SLICKENSIDES
								↓	EVERY ~ 0.2-0.5'
								↓	
								↓	
	8.7	10.0	87%	41				↓	
								↓	
70.5	◆							↓	
								↓	30° SLICKENSIDES
								↓	70.9, 71.7
								↓	VERTICAL FRACTURE
				71.9				↓	70.5-70.8, 71.9-72.1
					M. SOFT to M. HARD		GRAY SANDSTONE; U. FINE GRAINED, ARGILLACEOUS, SOME CROSS BEDDING, FEW IRREGULAR CALCAREOUS NODULES	BR-BL	
								↓	
	10.0	10.0	100%	78				↓	
								↓	VERTICAL FRACTURE
								↓	78.5-78.8, 80.0-80.5
80.5	◆							↓	
								↓	
								↓	
	10.0	10.0	100%	95				↓	CLOSED VERTICAL FRACTURE
				86.2				↓	84.3-85.3
					M. SOFT	MAROON + GRAY	SANDY CLAYSTONE	BR	
								↓	30° SLICKENSIDE
				89.6				↓	89.15
					M. SOFT to M. HARD	LT GRAY	SANDY SANDSTONE	BR	

REMARKS ** _____

* POCKET PENETROMETER READINGS
 ** METHOD OF ADVANCING AND CLEANING BORING

PROJECT AREA 2/3 JOHN E. AMOS POWER PLANT ST. ALBANS, WV

BORING NO. B-0519

ELEVATION _____ GWL 0 HRS 32.85

PROJECT NO. C040384.40-01

DATE 17-19 MAY 2005 CLASSIFIED BY DAN SANGER

PAGE 4 of 5

DEPTH (FT.)	BLOWS PER SIX INCHES OR CORE RECOVERY/RUN	CORE RECOVERY/RUN SAMPLE NO., TYPE & RECOVERY OR % ROCK RECOVERY	RQD (%) OR TORVANE	DESCRIPTION				USCS OR ROCK BROKENNESS	REMARKS*
				PROFILE	SOIL DENSITY - CONSISTENCY OR ROCK HARDNESS	COLOR	MATERIAL CLASSIFICATION		
1	2	3	4	5	6	7	8	9	10
90.5	◆				M. SOFT TO M. HARD	LT GRAY	SHALY SANDSTONE (CONT)	BR	10-20° FRACTURES
				94.0	↓	↓	↓	↓	91.1, 91.55, 92.0, 92.4, 92.6, 93.1,
	10.0	10.0	100%	50	M. SOFT	GRAY + MAROON MOTTLED	SANDY CLAYSTONE	BR	VERTICAL FRACTURE
				95.8	↓	↓	↓	↓	92.6 - 93.1, 94.3-94.6
					M. SOFT TO SOFT	MAROON	CLAYSTONE	BR-VBR	20-30° SLICKENSIDES EVERY ~ 0.1-0.3'
100.5	◆				↓	↓	↓	↓	100.5-102.7 VERY BROKEN ZONE, HEAVILY STAINED 100.5-101.7
				104.5	↓	GRAY	↓	↓	
	10.0	10.0	100%	58	M. SOFT TO M. HARD	LT GRAY	SITELY SANDSTONE	BR-BL	
					↓	↓	↓	↓	
110.5	◆				M. HARD	LT GRAY	SANDSTONE; MICACEOUS	BL	110.5-114.7 - 1 PIECE
				114.7	↓	↓	↓	↓	
	10.0	10.0	100%	77	M. SOFT	GRAY	SANDY SHALE	BL	VERTICAL FRACTURE
				117.5	↓	↓	↓	↓	115.25 - 115.75
					M. SOFT	GRAY + MAROON MOTTLED	CLAYSTONE	BR	20-30° SLICKENSIDES EVERY ~ 0.3-0.5'
					↓	↓	↓	↓	

REMARKS **

* POCKET PENETROMETER READINGS
** METHOD OF ADVANCING AND CLEANING BORING

PROJECT AREA 2/3 JOHN E. AMOS POWER PLANT ST. ALBANS, WI

BORING NO. B-0519

ELEVATION _____ GWL 0 HRS 32.85

PROJECT NO. C040384.1/3-01

DATE 17-19 MAY 2005

CLASSIFIED BY DAN SANGER

PAGE 5 of 5

DEPTH (FT.)	BLOWS PER SIX INCHES OR CORE RECOVERY/RUN	CORE RECOVERY/RUN SAMPLE NO., TYPE & RECOVERY OR % ROCK RECOVERY	RQD (%) OR TORVANE	DESCRIPTION				USCS OR ROCK BROKENNESS	REMARKS*
				PROFILE	SOIL DENSITY - CONSISTENCY OR ROCK HARDNESS	COLOR	MATERIAL CLASSIFICATION		
1	2	3	4	5	6	7	8	9	10
120.5	◆				M. SOFT	GRAY-MAROON	CLAYSTONE (CONT)	VB-L	20-30° SLICKENSIDES
								BL	~ EVERY 0.1-0.3'
							: SANDY 124.0-125.1		
125.9	10.0	10.0	100%	47	M. HARD	LT GRAY	SHALY SANDSTONE	BR	ROD IN THIS UNIT
129.15					M. SOFT	GRAY MAROON MOTTLED	INTERBEDDED SANDY CLAYSTONE AND SILTSTONE	BR	
							SOME SANDSTONE		
130.9	◆								
133.8									
135.3	10.0	10.0	100%	76	M. SOFT	MAROON	CLAYSTONE	VB-L	
					M. SOFT TO M. HARD	GRAY	SANDY CLAYSTONE WITH SMALL CALCAREOUS NODULES AND SCLINGERS	BR	LOW # FRACTURES
									136.05, 136.4, 136.8, 137.3, 137.9, 138.4, 138.9, 139.2
140.5	◆				M. SOFT	MAROON			
142.0					M. SOFT TO M. HARD	LT GRAY	SHALY SANDSTONE	BL	
							: CLAYSTONE SEAM		
146.3	10.0	10.0	100%	80			144.1-144.65		
					M. SOFT	GRAY	SANDY CLAYSTONE	BR	VERTICAL FRACTURE 147.2-
147.4						MAROON	CLAYSTONE		148.15
148.8									
					M. HARD	GRAY	SANDY SHALE/SHALY SANDSTONE	BL	

REMARKS ** POSITION OF BOLLING LBS.5

* POCKET PENETROMETER READINGS
** METHOD OF ADVANCING AND CLEANING BORING

PROJECT AREA 7/3 JOHN E. AMOS POWER PLANT ST. ALBANS, VT BORING NO. B-0520
 ELEVATION _____ GWL 0 HRS 18.6 PROJECT NO. C040387.40-01
 DATE 23 MAY 2005 CLASSIFIED BY DAN SANGER PAGE 1 of 4

DEPTH (FT.)	BLOWS PER SIX INCHES OR CORE RECOVERY/RUN	CORE RECOVERY/RUN SAMPLE NO., TYPE & RECOVERY OR % ROCK RECOVERY	RQD (%) OR TORVANE	DESCRIPTION				USCS OR ROCK BROKENNESS	REMARKS*
				PROFILE	SOIL DENSITY - CONSISTENCY OR ROCK HARDNESS	COLOR	MATERIAL CLASSIFICATION		
1	2	3	4	5	6	7	8	9	10
1.5	3	S-1			STIFF	maroon	SANDY CLAY AND ROCK FRAGMENTS	CL	* 2.0 TSP
3.0	4	REC. 1.5							* 2.5 TSP
4.5	5	S-3							* 2.0 TSP
6.0	6	REC. 1.5			M. DENSE	BROWN + BLACK	CLAYEY SILT AND ORGANICS	MI	WET
7.5	8	S-5		7.6					
7.6	33	REC. 1.5		7.6	V. DENSE	GRAY + MAROON	DECOMPOSED CLAYSTONE	GM	TOP OF ROCK: 7.6'
	4.4	100%	12		SOFT	MAROON	CLAYSTONE: HIGHLY WEATHERED	VB-BR	MOST PIECES 0.2
12.0				12.0			: GRAY 10.9 - 11.2		
				13.7	SOFT	GRAY	SANDY SHALE: WEATHERED	VB-BR	
					SOFT	MAROON	CLAYSTONE	BR	VERTICAL FRACTURE
									16.6 - 17.4
	9.3	10.0	93%			GRAY	: CALcareous NODULES 16.0-16.5 : SANDY 16.5-17.1		
						MAROON			20° SLICKEN SIDE 19.75
22.0									
	9.2	10.0	92%						30° SLICKEN SIDE 26.4 27.7, 28.7, 29.25, 29.8

REMARKS ** DRILLED BY TERRA TESTING, INC. USING A SIMCO 4000-T2 TRACK MOUNTED DRILL BORING ADVANCED USING 5/4" SOLID STEM AUGERS, 1" STEEL CASING, NQ-2 WIRELINE CORING TOOLS

* POCKET PENETROMETER READINGS
 ** METHOD OF ADVANCING AND CLEANING BORING

PROJECT AREA 2/3, JOHN E. AMOS POWER PLANT ST. ALBANS, WV

BORING NO. B-0520

ELEVATION _____ GWL 0 HRS 18.6

PROJECT NO. C040384.40-01

DATE 23 MAY 2005

HRS _____ CLASSIFIED BY DAN SANGER

PAGE 2 of 4

DEPTH (FT.)	BLOWS PER SIX INCHES OR CORE RECOVERY/RUN	CORE RECOVERY/SAMPLE NO., TYPE & RECOVERY OR % ROCK RECOVERY	RQD (%) OR TORVANE	DESCRIPTION				USCS OR ROCK BROKENNESS	REMARKS*
				PROFILE	SOIL DENSITY - CONSISTENCY OR ROCK HARDNESS	COLOR	MATERIAL CLASSIFICATION		
1	2	3	4	5	6	7	8	9	10
32.0	◆				SOFT	MARON	CLAYSTONE (CONT)	BR	
					↓	↓	↓	↓	
				35.5	↓	↓	↓	↓	
	9.9	10.0	99%	47	M. HARD	LT. GRAY	SHALY SANDSTONE / SANDY SHALE	BL	
				37.2	M. SOFT	MARON	CLAYSTONE	BR	
					↓	↓	↓	↓	
				40.2	↓	↓	↓	↓	
42.0	◆				M. HARD	LT. GRAY	SHALY SANDSTONE / SANDY SHALE	BR	VERTICAL FRACTURE
				41.7	↓	↓	↓	↓	40.4-41.0, 42.0-42.3
					M. SOFT	MARON	INTERBEDDED SANDY CLAYSTONE	BR-BL	
					M. HARD	GRAY	AND SANDY SHALE, FEW THIN (50.5') SANDSTONE UNITS, FEW IRREGULAR CALCAREOUS NODULES AND STRINGERS		
	10.0	10.0	100%	85					
					↓	↓	↓	↓	
52.0	◆				M. HARD	LT. GRAY	SILTY SANDSTONE	BL	
				52.1	↓	↓	↓	↓	
				54.4	M. SOFT	MARON + GREEN GRAY	CLAYSTONE w/ NUMEROUS IRREGULAR CALCAREOUS NODULES AND STRINGERS	RL-BR	SLICKENSIDES 56.1, 56.5, 56.7, 57.0, 60.7, 61.0, 61.3
	10.0	10.0	100%	81					
					↓	↓	↓	↓	

REMARKS ** _____

* POCKET PENETROMETER READINGS

** METHOD OF ADVANCING AND CLEANING BORING

PROJECT AREA 2/3, JOHN E. AMOS POWER PLANT, ST. ALBANS, WV

BORING NO. B-0520

ELEVATION _____ GWL 0 HRS 18.6

PROJECT NO. C040384.40-01

HRS _____

DATE 23 MAY 2005

CLASSIFIED BY DAN SANGER

PAGE 3 of 4

DEPTH (FT.)	BLOWS PER SIX INCHES OR CORE RECOVERY/RUN	CORE RECOVERY/TYPE & SAMPLE NO., TYPE & RECOVERY OR % ROCK RECOVERY	RQD (%) OR TORVANE	DESCRIPTION				USCS OR ROCK BROKENNESS	REMARKS*
				PROFILE	SOIL DENSITY - CONSISTENCY OR ROCK HARDNESS	COLOR	MATERIAL CLASSIFICATION		
1	2	3	4	5	6	7	8	9	10
62.0	◆				M. SOFT	MAKOOH GRAY	CLAYSTONE (CONT)	BR	
					↓	↓	↓	↓	
				66.2	↓	↓	↓	↓	
	10.0	10.0	100 1/2	75	M. SOFT	GRAY	SANDY CLAYSTONE, FEW SANDY SILTSTONE SEAMS	BR	
					↓	↓	↓	↓	
72.0	◆				↓	↓	↓	↓	
				73.6	↓	↓	↓	↓	
					M. SOFT	GRAY	INTERBEDDED SILTSTONE AND FINE GRAINED SANDSTONE	BA-BL	
					↓	↓	↓	↓	
	10.0	10.0	100 1/2	96	↓	↓	↓	↓	
					↓	↓	↓	↓	
82.0	◆				M. HARD	LT. GRAY	SANDSTONE	BL	
					↓	↓	↓	↓	
					↓	↓	↓	↓	
	9.9	10.0	99 1/2	100	↓	↓	↓	↓	
					↓	↓	↓	↓	

REMARKS ** _____

* POCKET PENETROMETER READINGS

** METHOD OF ADVANCING AND CLEANING BORING

PROJECT AREA 2/3, JOHN E. AMOS POWER PLANT, ST. ALBANS, WV

BORING NO. B-0520

ELEVATION _____ GWL 0 HRS 18.6

PROJECT NO. CO403840.Y0-J1

DATE 23 MAY 2005

CLASSIFIED BY DAN SANGER

PAGE 4 of 4

DEPTH (FT.)	BLOWS PER SIX INCHES OR CORE RECOVERY/RUN	SAMPLE NO., TYPE & RECOVERY OR % ROCK RECOVERY	ROD (%) OR TORVANE	DESCRIPTION				USCS OR ROCK BROKENNESS	REMARKS*
				PROFILE	SOIL DENSITY - CONSISTENCY OR ROCK HARDNESS	COLOR	MATERIAL CLASSIFICATION		
1	2	3	4	5	6	7	8	9	10
92.0	◆				M. HARD	LT GRAY	SANDSTONE (CONT)	BL	
	7.6	8.0	95%	77					
				97.8	↓	↓		↓	
100.0	▲				M. SOFT	GRAY + MUD	CLAYSTONE	BR	
							BOTTOM OF BORING: 100'		

REMARKS ** _____

* POCKET PENETROMETER READINGS
** METHOD OF ADVANCING AND CLEANING BORING

PROJECT AREA 2/3, JOHN E. AMOS POWER PLANT ST. ALBANS, WV BORING NO. B-0521
 ELEVATION ~1003 GWL 0 HRS 24.6 PROJECT NO. Co40384.40-01
 DATE 23 MAY 2005 CLASSIFIED BY DAN SANGER PAGE 1 of 3

DEPTH (FT.)	BLOWS PER SIX INCHES OR CORE RECOVERY/RUN	CORE RECOVERY/TYPE & SAMPLE NO., TYPE & RECOVERY OR % ROCK RECOVERY	RQD (%) OR TORVANE	DESCRIPTION				USCS OR ROCK BROKENNESS	REMARKS*
				PROFILE	SOIL DENSITY - CONSISTENCY OR ROCK HARDNESS	COLOR	MATERIAL CLASSIFICATION		
1	2	3	4	5	6	7	8	9	10
1.5	3	S-1			V. STIFF	MAROON	SILTY CLAY/CLAYEY SILT	U/M	< 3.0 TSF
3.0	6	S-2			DENSE	BROWN-GRAY	SANDY SILT, FEW SHALE FRAGMENTS	M	
3.4	7	S-2		3.4	V. DENSE	OLIVE	RECOMPRESSED SANDY SHALE		
	7.0	100%	40		SOFT	BROWN	SILTY SHALE, SOME SAND	BR	STAINED VERTICAL FRACTURE 4.5-5.1, 6.1-6.7
10.4				10.3	M-SOFT	BROWN-GRAY	SANDY SHALE	UBR-	LOW & STAINED FRACTURES 4.0, 5.1, 5.5, 6.1, 8.0, 8.5, 9.55
				13.3	M-HARD	BROWN-GRAY	SANDSTONE - MEDIUM GRAINED	BL	PIECES 0.1-0.4'
	10.0	100%	92						LOW & FRACTURES 28.2, 28.45, 28.85, 29.35, 29.85, 30.15, 30.3
20.4									VERTICAL STAINED FRACTURE 29.3-29.7

REMARKS ** DRIILLED BY TERRA TESTING, INC. USING A SIMCO 4000-T2 TRACK MOUNTED DRIILL

BORING ADVANCED USING 5/4" SOLID STEM AUGERS, 4" STEEL CASING, NR-2 WIRELINE CORING TOOLS

* POCKET PENETROMETER READINGS
 ** METHOD OF ADVANCING AND CLEANING BORING

PROJECT AREA 2/3, JOHN E. AMOS POWER PLANT ST. ALBANS, WV BORING NO. B-0521
 ELEVATION 1003± GWL 0 HRS 24.6 PROJECT NO. C040384.40-01
 DATE 23 MAY 2005 CLASSIFIED BY DAN JANIGER PAGE 2 of 3

DEPTH (FT.)	BLOWS PER SIX INCHES OR CORE RECOVERY/RUN	SAMPLE NO., TYPE & RECOVERY OR % ROCK RECOVERY	ROD (%) OR TORVANE	DESCRIPTION				USCS OR ROCK BROKENNESS	REMARKS*
				PROFILE	SOIL DENSITY - CONSISTENCY OR ROCK HARDNESS	COLOR	MATERIAL CLASSIFICATION		
1	2	3	4	5	6	7	8	9	10
30.4	◆				M. HARD	BROWN-GRAY	SANDSTONE : MEDIUM GRAINED MICACEOUS (CONT)	BL	ALL BREAKS ARE MECHANICAL - CORE IN 4' AND 6' PIECES - BRAKE DURING HANDLING
	10.0	10.0	100%	100					
40.4	◆								
	10.0	10.0	100%	100					
50.4	◆								
	9.7	10.0	97%	94					0.05' CARBONACEOUS SHALE AT 59.8

REMARKS ** _____

PROJECT AREA 7/3, JOHN E. AMOS POWER PLANT ST. ALBANS, WV BORING NO. B-0521
 ELEVATION 1003 ± GWL 0 HRS 24.6 PROJECT NO. C040384.40-01
 DATE 23 MAY 2005 CLASSIFIED BY DAN JANGER PAGE 3 of 3

DEPTH (FT.)	BLOWS PER SIX INCHES OR CORE RECOVERY/RUN	CORE RECOVERY/RUN SAMPLE NO., TYPE & RECOVERY OR % ROCK RECOVERY	RQD (%) OR TORVANE	DESCRIPTION				USCS OR ROCK BROKENNESS	REMARKS*
				PROFILE	SOIL DENSITY - CONSISTENCY OR ROCK HARDNESS	COLOR	MATERIAL CLASSIFICATION		
1	2	3	4	5	6	7	8	9	10
60.4	◆				M-HARD	DRY GRAY	SANDSTONE (COPT)	BL	
				64.0	↓	↓	↓	↓	
	9.6	10.0	96%	58	M-SOFT	LT GRAY	SANDY CLAYSTONE w/ CALCAREOUS NODULES	BR	
				66.5		GRAY	SILTY CLAYSTONE		
						MAROON	CLAYSTONE		30° SLICES AT 66.75, 67.6, 68.0, 68.25, 68.4, 68.6, 69.1, 69.45, 69.7, 70.3, 70.4
70.4	▲			70.4	↓	↓	↓	↓	
							BOTTOM OF BORING : 70.4'		

REMARKS ** _____

* POCKET PENETROMETER READINGS
 ** METHOD OF ADVANCING AND CLEANING BORING

N 543873.4417
E 1722326.4148 Grade El. 901.64



PROJECT AREA 2/3 JOHN E. AMOS POWER PLANT ST. ALBANS, WV BORING NO. B-0522
ELEVATION 902± GWL 0 HRS 56.8 PROJECT NO. C040384.4/0-01
DATE 24-25 MAY 2005 CLASSIFIED BY DAN SANGER PAGE 1 of 9

DEPTH (FT.)	BLOWS PER SIX INCHES OR CORE RECOVERY/RUN	CORE RECOVERY/RUN SAMPLE NO., TYPE & RECOVERY OR % ROCK RECOVERY	RQD (%) OR TORVANE	PROFILE	DESCRIPTION			USCS OR ROCK BROKENNESS	REMARKS*
					SOIL DENSITY - CONSISTENCY OR ROCK HARDNESS	COLOR	MATERIAL CLASSIFICATION		
1	2	3	4	5	6	7	8	9	10
1.5	2	S-1			V-STIFF	MAROON	SILTY CLAY	CI	* 3.5 TSF
3.0	5	REC. 0.6 S-2		3.4	↓	↓	↓	↓	
4.2	18 38	S-3 REC 1.0		4.2	V-DENSE	OLIVE-GRAY	DECOMPOSED SANDY SHALE		
				11.1	SOFT TO M-SOFT	OLIVE + GRAY	INTERBEDDED SANDY SHALE AND SHALY SANDSTONE	BR	TOP OF ROCK: 4.2' LOW & FRACTURES 11.7, 5.1, 6.1, 6.85, 6.95, 7.35 STAINED 30° FRACTURE 8.4 VERTICAL STAINED FRACTURE 8.85-9.2 STAINED LOW & FRACTURES 10.8, 11.6, 12.55, 12.65, 14.7, 14.9, 15.2, 15.3, 15.9, 16.05, 16.45, 16.5, EVERY 0.1 TO 0.3' 16.5-
	6.3	100%	63						
10.5									
	10.0	10.0	100%	36				VBR	
								BR	
20.5				20.0	SOFT TO V-SOFT	MAROON GRAY	CLAYSTONE	BR	
								BL	
	8.8	10.0	88%	46				UVR-BR	
				27.0	M-HARD	GRAY	SHALY SANDSTONE	BR	STAINED VERTICAL FRACTURE 27.0-28.0
									30.7-30.9

REMARKS ** DRIILLED BY TERRA TESTING, INC USING A SIMCO 4000-T2 TRACK MOUNTED DRILL
BORING ADVANCED USING 5 1/4" SOLID STEM AUGERS, 4" STEEL CASING, NQ-2 WIRELINE CORING TOOLS

* POCKET PENETROMETER READINGS
** METHOD OF ADVANCING AND CLEANING BORING

BORING NO. B-0522
(1.0)

PROJECT AREA 2/3, JOHN E. AMST POWER PLANT ST. ALBANS, VT BORING NO. B-0522
 ELEVATION 902 ± GWL 0 HRS 56.8 PROJECT NO. C040384-400
 DATE 24-25 MAY 2005 CLASSIFIED BY DAN SANGER PAGE 2 of 9

DEPTH (FT.)	BLOWS PER SIX INCHES OR CORE RECOVERY/RUN	CORE RECOVERY/TYPE & SAMPLE NO., TYPE & RECOVERY OR % ROCK RECOVERY	RQD (%) OR TORVANE	DESCRIPTION				USCS OR ROCK BROKENNESS	REMARKS*
				PROFILE	SOIL DENSITY - CONSISTENCY OR ROCK HARDNESS	COLOR	MATERIAL CLASSIFICATION		
1	2	3	4	5	6	7	8	9	10
30.5	◆			31.1	V. SOFT	MAROON	CLAYSTONE	VR	NO RECOVERY IN THIS UNIT
	3.6	10.0	36%	24					
				37.5	M. SOFT	OLIVE + GRAY	INTERLEAVED CLAYSTONE AND SANDY SHALE	BR	LOW & FRACTURES
									41.45, 41.7, 41.9, 43.7, 43.8, 46.8, 48.4, 49.4, 50.0, 50.9, 51.1, 51.4, 52.2
40.5	◆								STAINED HIGH & FRACTURES 45.5-46.5
									47.4-47.9, 48.7-48.95
	10.0	10.0	100%	56					
				52.3	M. SOFT	OLIVE-GRAY	SANDY SHALE	BR	LOW & FRACTURES 52.7, 53.9, 54.3, 54.65, 55.1, 56.4, 57.45, 59.3
									STAINED LOW & FRACTURES 53.45, 55.75-55.9, 56.5, 57.1, 58.9 60.0
	10.0	10.0	100%	80					
				57.9	SOFT TO M. SOFT	MAROON + GRAY	CLAYSTONE	BR-VR	HIGH & STAINED FRACTURE 58.7-59.3

REMARKS **

* POCKET PENETROMETER READINGS
 ** METHOD OF ADVANCING AND CLEANING BORING

PROJECT AREA 2/3, JOHN E. AMOS POWER PLANT ST. ALBANS, VT BORING NO. B-0522
 ELEVATION 902± GWL 0 HRS 56.8 PROJECT NO. C040384.4J-U1
 DATE 24 MAY 2005 CLASSIFIED BY DAN SANGER PAGE 3 of 9

DEPTH (FT.)	BLOWS PER SIX INCHES OR CORE RECOVERY/RUN	CORE RECOVERY/RUN SAMPLE NO., TYPE & RECOVERY OR % ROCK RECOVERY	RQD (%) OR TORVANE	DESCRIPTION				USCS OR ROCK BROKENNESS	REMARKS*
				PROFILE	SOIL DENSITY - CONSISTENCY OR ROCK HARDNESS	COLOR	MATERIAL CLASSIFICATION		
1	2	3	4	5	6	7	8	9	10
60.5	◇			60.7					
					M. SOFT	GRAY	SANDY SHALE	BR	STAINED LOW% FRACTURES 60.75, 61.0, 61.5, 61.9
				63.0	↓	↓	↓		
				64.0	M. SOFT	MAROON	CLAYSTONE		
					M. SOFT	GRAY	SILTY SANDSTONE / SANDY SHALE		HEAVILY STAINED NEAR VERTICAL FRACTURE 65.35-67.8
	10.0	100%	36						67' 100% WATER LOSS * STAINED VERTICAL FRACTURE 68.1-68.7, 69.2-70.3
70.5	◇			70.4				VBR	
						MAROON + GRAY	CLAYSTONE	BR	VERTICAL FRACTURE 74.6-76.5
								VBR	
	10.0	100%	61					BR	
							SANDY 78.5-80.5	BR	
80.5	◇								LOW% FRACTURE 80.8, 81.2, 83.1, 83.7, 84.5
								VBR	U. BLOWED ZONE 81.3-83.1
						DK GRAY			
								BR	HIGH% FRACTURE 84.2-84.45
	10.0	100%	57	86.1					
					M. SOFT	GRAY	SILTSTONE	BR	LOW% FRACTURE 87.1, 87.65, 88.3, NEAR VERTICAL FRACTURE 88.5-89.2

REMARKS **

* POCKET PENETROMETER READINGS
 ** METHOD OF ADVANCING AND CLEANING BORING

PROJECT AREA 2/3 JOHN E. AMOS POWER PLANT, ST. ALBANS, WV

BORING NO. B-0522

ELEVATION 902.1 GWL 0 HRS 56.8

PROJECT NO. C040384.40-01

DATE 24-25 MAY 2005 CLASSIFIED BY DAN SANGER

PAGE 4 of 9

DEPTH (FT.)	BLOWS PER SIX INCHES OR CORE RECOVERY/RUN	SAMPLE NO., TYPE & RECOVERY OR % ROCK RECOVERY	RQD (%) OR TORVANE	DESCRIPTION				USCS OR ROCK BROKENNESS	REMARKS*
				PROFILE	SOIL DENSITY - CONSISTENCY OR ROCK HARDNESS	COLOR	MATERIAL CLASSIFICATION		
1	2	3	4	5	6	7	8	9	10
90.5	◆			90.0	M. HARD	LT GRAY	SHALY SANDSTONE MICACEOUS	BL	
	10.0	10.0	100%	93					
100.5	◆								
	10.0	10.0	100%	95			SHALE 107.0 - 107.6 (BA)		
							SHALE PEBBLES/CHIPS 108.6 - 109.8		
110.5	◆								
	10.0	10.0	100%	95					

REMARKS **

* POCKET PENETROMETER READINGS
** METHOD OF ADVANCING AND CLEANING BORING

PROJECT AREA 2/3, JOHN E. AMOS POWER PLANT ST. ALBANS, VT

 BORING NO. B-0522

 ELEVATION 902± GWL 0 HRS 56.8

 PROJECT NO. C040384.40-01

 DATE 24-26 MAY 2005

 CLASSIFIED BY DAN SANGER

 PAGE 5 of 9

DEPTH (FT.)	BLOWS PER SIX INCHES OR CORE RECOVERY/RUN	SAMPLE NO., TYPE & RECOVERY OR % ROCK RECOVERY	RQD (%) OR TORVANE	DESCRIPTION				USCS OR ROCK BROKENNESS	REMARKS*
				PROFILE	SOIL DENSITY - CONSISTENCY OR ROCK HARDNESS	COLOR	MATERIAL CLASSIFICATION		
1	2	3	4	5	6	7	8	9	10
120.5	◇				M-HARD HARD	LT GRAY	SANDSTONE (COIT)	BL	
	10.0	10.0	100%	100					
130.5	◇								
	10.0	10.0	100%	100					
140.5	◇								
	10.0	10.0	100%	100					

REMARKS ** _____

 * POCKET PENETROMETER READINGS
 ** METHOD OF ADVANCING AND CLEANING BORING

PROJECT AREA 2/3 JOHN E. AMOS POWER PLANT ST. ALBANS, WV BORING NO. B-0522
 ELEVATION 902± GWL 0 HRS 56.8 PROJECT NO. C040384.43-01
 DATE 24-25 MAY 2005 CLASSIFIED BY DAN SANGER PAGE 6 of 9

DEPTH (FT.)	BLOWS PER SIX INCHES OR CORE RECOVERY/RUN	SAMPLE NO., TYPE & RECOVERY OR % ROCK RECOVERY	RQD (%) OR TORVANE	DESCRIPTION				USGS OR ROCK BROKENNESS	REMARKS*
				PROFILE	SOIL DENSITY - CONSISTENCY OR ROCK HARDNESS	COLOR	MATERIAL CLASSIFICATION		
1	2	3	4	5	6	7	8	9	10
150.5	◆			150.8			SANDSTONE (CONT)		
					S>FT	MAROON, GRAY, PURPLE, YELLOW	CLAYSTONE, SOME SAND	BR	
				154.5	↓	↓	↓	↓	30° SLICKENSIDES 153.05, 153.6, 154.0
	10.0	10.0	100%	75	M. SOFT TO M. HARD	GRAY TO LT. GRAY	INTERBEDDED SANDY SHALE AND SANDSTONE	BL	
160.5	◆								
	10.0	10.0	100%	100					
170.5	◆								
				173.0	↓	↓	↓	↓	
				174.7	S>FT	GRAY	CLAY SHALE	BR	
	10.0	10.0	100%	72	S>FT	DK GRAY + MAROON	SILTY TO SANDY CLAYSTONE	BR	20-30° SLICKENSIDES
					↓	↓	↓	↓	175.0, 175.4, 175.55, 176.1, 176.6, 177.35, 177.65, 177.75, 178.35, 179.15, 179.4,
					↓	↓	↓	↓	IRREGULAR CALCAREOUS SPANGERS 179.4-180.0

REMARKS ** _____

* POCKET PENETROMETER READINGS
 ** METHOD OF ADVANCING AND CLEANING BORING

PROJECT AREA 2/3, JOHN E. AMOS POWER PLANT, ST ALBERT, WV BORING NO. B-0522
 ELEVATION 1021 GWL 0 HRS 56.8 PROJECT NO. 043224301
 DATE 24-25 MAY 2005 CLASSIFIED BY DAN SANGER PAGE 7 of 9

DEPTH (FT.)	BLOWS PER SIX INCHES OR CORE RECOVERY/RUN	SAMPLE NO., TYPE & RECOVERY OR % ROCK RECOVERY	ROD (%) OR TORVANE	DESCRIPTION				USCS OR ROCK BROKENNESS	REMARKS*
				PROFILE	SOIL DENSITY - CONSISTENCY OR ROCK HARDNESS	COLOR	MATERIAL CLASSIFICATION		
1	2	3	4	5	6	7	8	9	10
180.5	◆			180.0	M. SOFT	GRAY	SILTALY SILTSTONE	BL	
				183.0	M. SOFT TO SOFT	MAROON + GRAY	CLAYSTONE	BL - BR	30° SLICKENSIDES AT 185.1, 185.3, 185.5, 186.4, 186.7, 187.0, 187.2, 187.55, 188.1
	10.0	10.0	100%	78					
				188.6					
190.5	◆				SOFT TO M. SOFT	MAROON + GRAY	INTERBEDDED CLAYSTONE AND SANDY SHALE, SOME SANDSTONE,	BL	
	10.0	10.0	100%	90					
				200.5					
					M. SOFT	MAROON + GRAY	CLAYSTONE	BA-BL	20-30° SLICKENSIDES 202.3, 202.65, 202.9, 203.2, 203.45, 203.7
	10.0	10.0	100%	86					
				206.5	M. HARD	GRAY	SANDY SILTSTONE	BL	
				209.7					

REMARKS **

PROJECT AREA 2/3, JOHN E. AMOS POWER PLANT, ST. ALBANS, WV

BORING NO. B-0522

ELEVATION 902 ± GWL 0 HRS 56.8

PROJECT NO. C04038440-01

DATE 24-25 MAY 2005

HRS _____
CLASSIFIED BY DAN SANGER

PAGE 8 of 9

DEPTH (FT.)	BLOWS PER SIX INCHES OR CORE RECOVERY/RUN	CORE RECOVERY/RUN SAMPLE NO., TYPE & RECOVERY OR % ROCK RECOVERY	ROD (%) OR TORVANE	PROFILE	DESCRIPTION			USCS OR ROCK BROKENNESS	REMARKS*
					SOIL DENSITY - CONSISTENCY OR ROCK HARDNESS	COLOR	MATERIAL CLASSIFICATION		
1	2	3	4	5	6	7	8	9	10
210.5	◆				M. HARD	LT. GRAY	SANDSTONE: FINE TO MEDIUM GRAINED, MICACEOUS	BL	
10.0	10.0	100%	100						
220.5	◆			220.0	M. SOFT TO SOFT	MAROON, GRAY, PURPLE, GREEN-GRAY	CLAYSTONE : SILTY 220-225'	BR	
10.0	10.0	100%							225-250.5 - CORE PIECES 0.2-0.4' ~1/20-30° SLICKE SIDES
							CALCAREOUS NOBULES 227.5-235.5'		
230.5	◆								
10.0	10.0	100%							

REMARKS ** _____

* POCKET PENETROMETER READINGS
** METHOD OF ADVANCING AND CLEANING BORING

BORING NO. B-0522

(18)

PROJECT AREA 2/3, JOHN E. AMOS POWER PLANT, ST. ALBANS, WV BORING NO. B-0522
 ELEVATION 902± GWL 0 HRS 56.8 PROJECT NO. C040384.40-01
 DATE 24-25 MAY 2005 CLASSIFIED BY DAN SANGER PAGE 9 of 9

DEPTH (FT.)	BLOWS PER SIX INCHES OR CORE RECOVERY/RUN	SAMPLE NO., TYPE & RECOVERY OR % ROCK RECOVERY	RQD (%) OR TORVANE	PROFILE	SOIL DENSITY - CONSISTENCY OR ROCK HARDNESS	COLOR	DESCRIPTION	USCS OR ROCK BROKENNESS	REMARKS*
							MATERIAL CLASSIFICATION		
1	2	3	4	5	6	7	8	9	10
240.5	◆				M. SOFT	MARON/ GRAY	CLAYSTONE (CONT)	BR	CORE PIECES 0.2-0.4' 42-30° SLOKEN SIDES
					TO SOFT	PURPLE GREEN GRAY			
10.0	10.0	100%					SILT 247.8-248.9		
250.5	▲						BOTTOM OF BORING: 250.5'		

REMARKS **

* POCKET PENETROMETER READINGS
 ** METHOD OF ADVANCING AND CLEANING BORING

N 542742.2422
E 1722248.6749 Grade El. 696.90



PROJECT AREA 23, JOHN E. AMOS POWER PLANT, STALBANS, WV BORING NO. B-0523
ELEVATION _____ GWL 0 HRS 220 PROJECT NO. COM384.40-01
DATE 24 MAY 2005 CLASSIFIED BY DAN SANGER PAGE 1 of 2

DEPTH (FT.)	BLOWS PER SIX INCHES OR CORE RECOVERY/RUN	CORE RECOVERY/RUN SAMPLE NO., TYPE & RECOVERY OR % ROCK RECOVERY	RQD (%) OR TORVANE	DESCRIPTION				USCS OR ROCK BROKENNESS	REMARKS*
				PROFILE	SOIL DENSITY - CONSISTENCY OR ROCK HARDNESS	COLOR	MATERIAL CLASSIFICATION		
1	2	3	4	5	6	7	8	9	10
1.5	1	S-1 REC. 0.7		2.0	V. LOOSE	Brown	SILT, SOME CLAY	ml	
3.0	4	S-2 REC. 1.2			↓		↓		
4.5	4	S-3 REC. 0.6			↓		CLAYEY SILT AND ROCK FRAGMENTS		
6.0	4	S-4 REC. 0.5		6.0	↓		↓		
7.5	4	S-5 REC. 0.3			STIFF	Brown GRAY MAADON	CLAYEY SILT / SILTY CLAY AND ROCK FRAGMENTS	ml-cl	MOIST x 2.0 TSF
9.0	8	S-6 REC. 1.5			V. STIFF		SILTY CLAY - DECOMPOSED CLAYSTONE		# 3.0 TSF
10.5	5	S-7 REC. 1.1			↓		↓		
12.0	10	S-8 REC. 0.6		12.0	HARD		↓		* > 4.5 TSF
13.5	10	S-9 REC. 1.3			V. DENSE	MAADON GRAY YELLOW	DECOMPOSED CLAYSTONE	gm-gc	
15.0	23	S-10 REC. 0.9			↓		↓		
16.5	17	S-11 REC. 0.8			↓		↓		
17.9	20	S-12 REC. 0.4		17.9	↓		↓		TOP OF ROCK: 17.9'
	34	S-13 REC. 4.1	4!!		SOFT	MAADON BROWN GRAY	CLAYSTONE: HIGHLY WEATHERED	BR-BL	LOW & FRACTURE 19.5, 20.3, 20.5 21.0, 21.2 45° SLICEPSIDE 20.5-20.65
22.0	10.0	100% 88							LOW & FRACTURES 23.6, 24.55, 24.85 26.4, 27.9, 29.1 30.3, 30.6, 31.2

REMARKS - DRILLED BY TERRA TESTING INC USING A SIMCO 4000-T2 TRACK MOUNTED DRILL BORING ADVANCED USING 5/8" SOLIDSTEM AUGERS, 4" STEEL CASING, NQ-2 WIRELINE CORING TOOLS

* POCKET PENETROMETER READINGS
** METHOD OF ADVANCING AND CLEANING BORING

BORING NO. B-0523

PROJECT AREA 2/3 JOHN E. AMIS POWER PLANT, ST. ALBANS, VT

BORING NO. B-0523

ELEVATION 69.6± GWL 0 HRS 22.0

PROJECT NO. C050384 43-0

DATE 24 MAY 2005

CLASSIFIED BY DAN SANGER

PAGE 2 of 2

DEPTH (FT.)	BLOWS PER SIX INCHES OR CORE RECOVERY/RUN SAMPLE NO., TYPE & RECOVERY OR % ROCK RECOVERY	RQD (%) OR TORVANE	DESCRIPTION					USCS OR ROCK BROKENNESS	REMARKS*
			PROFILE	SOIL DENSITY - CONSISTENCY OR ROCK HARDNESS	COLOR	MATERIAL CLASSIFICATION			
1	2	3	4	5	6	7	8	9	10
32.0	◆				SOFT TO M-SOFT	MARL + GRAY	CLAYSTONE (CONT)	BR	
				34.7	↓	↓	↓		LOW & FRACTURES 34.0, 34.5, 34.7
	19.0 19.0	100%	65	36.5	M-SOFT	GRAY	SHALY SANDSTONE	↓	
				32.5	SOFT	MARL	CLAYSTONE	BR	LOW & FRACTURES 37.05, 37.9, 38.1
				40.3	M-SOFT TO M-HARD	GRAY	SHALY SANDSTONE	BR	
42.0	◆				SOFT	MARL + GRAY	CLAYSTONE	BR	LOW & FRACTURES 40.5, 40.6, 40.8, 40.9, 41.1, 42.4, 43.3, 43.45, 43.7
	8.0 8.0	100%	73						30 SUCKENSINES 42.75, 43.9, 44.2, 44.4, 44.7, 44.85, 45.0, 45.75, 48.0, 49.4
50.0	▲								VERTICAL FRAC. 49.0-48.5
							BOTTOM OF BORING: 50.0'		

REMARKS **

* POCKET PENETROMETER READINGS
** METHOD OF ADVANCING AND CLEANING BORING

N 542745.0961
 E 1722251.4149 Grade El. 696.91



PROJECT AREA ²/₃ JOHN E. AMOS POWER PLANT ST. ALBANS, WV BORING NO. B-0524
 ELEVATION _____ GWL 0 HRS DRY PROJECT NO. C040384.40-01
 DATE 25 MAY 2005 CLASSIFIED BY DIAN SANGER PAGE 1 of 1

DEPTH (FT.)	BLOWS PER SIX INCHES OR CORE RECOVERY/RUN	SAMPLE NO., TYPE & RECOVERY OR % ROCK RECOVERY	ROD (%) OR TORVANE	DESCRIPTION				USCS OR ROCK BROKENNESS	REMARKS*
				PROFILE	SOIL DENSITY - CONSISTENCY OR ROCK HARDNESS	COLOR	MATERIAL CLASSIFICATION		
1	2	3	4	5	6	7	8	9	10
							AUGER w/d. SAMPLING TO 18 FT		
							INSTALL PIEZOMETER, TIP AT 18 FT		
							SEE BORING B-0523 FOR SOIL DESCRIPTIONS		
							↓		
18.0				18.0			BOTTOM OF BORING: 18.0 FT		

REMARKS** DRILLED BY TERRA TESTING USING A SIMCO 4000-T2 TRACK MOUNTED DRILL
BORING ADVANCED USING 5/4" SOLID STEM AUGERS

* POCKET PENETROMETER READINGS
 ** METHOD OF ADVANCING AND CLEANING BORING

N 542379.9472
E 1721745.3670

Grade El. 679.43



PROJECT AREA 2/3, JOHN E. AMOS POWER PLANT, ST. ALBANS, WV

BORING NO. B-0525

ELEVATION _____ GWL 0 HRS DRY

PROJECT NO. C040384.43-01

HRS _____

DATE 25 MAY 2005

CLASSIFIED BY DAN SANGER

PAGE 1 of 1

DEPTH (FT.)	BLOWS PER SIX INCHES OR CORE RECOVERY/RUN	SAMPLE NO., TYPE & RECOVERY OR % ROCK RECOVERY	ROD (%) OR TORVANE	PROFILE	SOIL DENSITY - CONSISTENCY OR ROCK HARDNESS	COLOR	DESCRIPTION		USCS OR ROCK BROKENNESS	REMARKS*
							MATERIAL CLASSIFICATION			
1	2	3	4	5	6	7	8	9	10	
							AUGER w/o SAMPLING TO 10 FT.			
							INSTALL PIEZOMETER TIP AT 10 FT			
							SEE BORING B-0520 FOR SOIL DESCRIPTION			
							↓			
10.0				10.0			BOTTOM OF BORING 10.0 FT			

REMARKS** DRILLED BY TERRA TESTING, INC. USING A SIMCO 4000-T2 TRACK MOUNTED DRILL.
BORING ADVANCED USING 5/4" SOLID STEM AUGERS

* POCKET PENETROMETER READINGS
** METHOD OF ADVANCING AND CLEANING BORING
BORING NO. B-0525
(16)

N 539371.31
E 1753962.87

Grade El. 709.57 Top of PVC Riser El. 711.47



PROJECT Area 2/3 John E. Amos Power Plant

BORING NO. 0536 (mw-1)

ELEVATION _____ GWL 0 HRS Dry

PROJECT NO. 040384.40.01

DATE 7-12-05 24 HRS 13.8

CLASSIFIED BY TR Gower

PAGE 1 of 1

DEPTH (FT.)	BLOWS PER SIX INCHES OR CORE RECOVERY/RUN	CORE RECOVERY/TYPE & SAMPLE NO., TYPE & RECOVERY OR % ROCK RECOVERY	ROD (%) OR TORVANE	DESCRIPTION				USCS OR ROCK BROKENNESS	REMARKS*
				PROFILE	SOIL DENSITY - CONSISTENCY OR ROCK HARDNESS	COLOR	MATERIAL CLASSIFICATION		
1	2	3	4	5	6	7	8	9	10
				8.0		Red BR	Clayey Silt and Rock Fragments - Trace Sand		Start 1:35 moist
				10.0		BR	Sand and Rock Fragments		Damp RF > 2" φ
				11.0		Red BR	Clayey Silt and Rock Fragments		Moist RF < 2" φ
				19.0		Red	Decomposed Claystone		Damp. Dry @ 14'
							Bottom @ 19.0'		Finish 2:00
							Installation		Material
							Sand 19.0' to 18.0'		10' Screen, cap
							10' Screen 18.0' to 8.0'		9 Bags Sand
							Sand 18.0' to 6.0'		1 3/4 Bucket Pellets
							Bentonite Pellets 6.0' to 3.0'		10 Bags Concrete Mix
							Water added to pellets		1 6" x 5' Steel Casing
							1.9' Stack up PVC		
							2.3' Stack up Steel Casing		

REMARKS** 4 1/4" ID Hollow Stem Augers to 19.0', 4000-T2 Simco Track Drill
Doug Novotny Driller, Terra Testing

* POCKET PENETROMETER READINGS
** METHOD OF ADVANCING AND CLEANING BORING

BORING NO. 0536 (mw-1)



PROJECT Area 2/3 John E Amos Power Plant

BORING NO. 0535 (MW-2)

ELEVATION _____ GWL 0 HRS 40.1'

PROJECT NO. C040384.40.01

DATE 7-12-05 24 HRS 38.2'

CLASSIFIED BY T.R. Gower

PAGE 1 of 1

DEPTH (FT.)	BLOWS PER SIX INCHES OR CORE RECOVERY/RUN	SAMPLE NO., TYPE & RECOVERY OR % ROCK RECOVERY	RQD (%) OR TORVANE	DESCRIPTION				USCS OR ROCK BROKENNESS	REMARKS*
				PROFILE	SOIL DENSITY - CONSISTENCY OR ROCK HARDNESS	COLOR	MATERIAL CLASSIFICATION		
1	2	3	4	5	6	7	8	9	10
						Red	Clayey Silt and Rock		Moist, start 8:45
						BRN	Fragments - trace sand		RF 72" φ
				10.0		↓	↓		
						Red	Decomposed Claystone		Dry
				18.0		↓	↓		TOR 18.0'
				20.0		Red	weathered Claystone		Auger to 20.0'
						BRN	Fine Grain Sandstone w/		
				23.0		Red	Interbedded claystone		
						Hard Gray	Interbedded sandstone &		
				30.0		↓	Siltstone - few thin Red		
						↓	Claystone Seams		
				34.2		Red	Claystone		Few sec. of moist
						↓	↓		cuttings @ 42.0'
				39.0		Gray	Siltstone/shale		with some @ 42'
						↓	↓		is one of water
				60.0		Red	Claystone		Moist cuttings back
						Gray	Siltstone		@ 62 wait 15 min
				62.5		↓	↓		water in hole
							Bottom @ 62.5'		End 10:35 AM
							Installation		Materials
							Sand 62.5 to 62.0'		20' 2" φ PVC Screen
							Screen 62.0' to 42.0'		4 Bags Sand
							Sand 62.0' to 37.0'		1/4 Bucket Pellets
							Bentonite Pellets 37.0 - 34.0		4 Bags Volclay grout
							Pellets into water		10 Bag Concrete Mix
							Volclay to 4.0'		
							Concrete 4.0 to 0.0', 6' φ Red		
							Steel Casing 2.1' stickup		

REMARKS * 4 1/4" ID Hollow Stem Augers to 20', 4" φ Air Rotary to 62.5'
Since 4000-T2 Track Drill, Doug Novotny Driller, Terra Testing

* POCKET PENETROMETER READINGS

** METHOD OF ADVANCING AND CLEANING BORING

N 541672.50
E 1755563.50

Grade El. 823.00 Top of PVC Riser El. 825.00



PROJECT Area 2/3 John E Amos Power plant

BORING NO. 0527 (MW-3)

ELEVATION _____ GWL 0 HRS Dry

PROJECT NO. C040384.40.01

DATE 6-24-05 48 HRS 17.0

CLASSIFIED BY TR Gower

PAGE 1 of 1

DEPTH (FT.)	BLOWS PER SIX INCHES OR CORE RECOVERY/RUN	CORE RECOVERY/TYPE & SAMPLE NO., TYPE & RECOVERY OR % ROCK RECOVERY	ROD (%) OR TORVANE	DESCRIPTION				USCS OR ROCK BROKENNESS	REMARKS*
				PROFILE	SOIL DENSITY - CONSISTENCY OR ROCK HARDNESS	COLOR	MATERIAL CLASSIFICATION		
1	2	3	4	5	6	7	8	9	10
				2.0'		Red- BR.	Silty Clay		Start 10:15 AM Damp
				12.0'		BR	clayey silt		Dry
				25.5'		Red- BR.	Silty Clay to Decomposed claystone		Dry, slow augering damp at 21.6' moist at 25'
				30.0'		Gray BR	Weathered sandstone-with fine mica grains		Auger Refusal 29.5'
				41.0'		Red	Siltstone		6-27-05 WL=17'
							Bottom @ 41.0'		Start air rotary @ 8:30 AM
							Installation		Finish @ 9:00 AM
							Pellets 41 to 32.5'		Clean hole 9:00 to 11:00. Drilling while cleaning 41.0'
							Sand 32.5 to 32.0		Material
							20' Screen 32.0'-12.0'; 1 1/2" cap		20' 2" d screen
							32.0 to 9.0' Sand		2 caps
							Bentonite pellets 9.0' to 9.0'		12 bags sand
							1 bucket water poured in pellets		1 bucket pellets
							Volclay grout to 3.3'		1/2 Bag Volclay
							Concrete Mix 10 Bags		10 Bags Concrete Mix
							5' steel pipe 6" d 2.5' stick up		6" x 5' Steel Casing
							2' PVC stick up		
							2.5' steel Casing stick up		

REMARKS ** 30' south of 0509, 4 1/4" ID HSA to 25.5', 4" d air rotary w/hammer to 41.0'

Simco 4000-Ta Track Rig, Doug Novotny Driller, Terra Testing

* POCKET PENETROMETER READINGS
** METHOD OF ADVANCING AND CLEANING BORING

BORING NO. 0527 (MW-3)

N 542305.16
E 1753086.04

Grade El. 674.76 Top of PVC Riser El. 676.36



PROJECT Area 2/3 John E Amos Power Plant

BORING NO. 0532 (mw-4)

ELEVATION _____ GWL 0 HRS 19.2'

PROJECT NO. C040354.40.01

DATE 7-7-05 24 HRS 17.9'

CLASSIFIED BY TR Gower

PAGE 1 of 1

DEPTH (FT.)	BLOWS PER SIX INCHES OR CORE RECOVERY/RUN	CORE RECOVERY/TYPE & SAMPLE NO., TYPE & RECOVERY OR % ROCK RECOVERY	ROD (%) OR TORVANE	DESCRIPTION				USCS OR ROCK BROKENNESS	REMARKS*
				PROFILE	SOIL DENSITY - CONSISTENCY OR ROCK HARDNESS	COLOR	MATERIAL CLASSIFICATION		
1	2	3	4	5	6	7	8	9	10
				2.0		BR	Sandy Silt		Damp, start 9:45
						BR	Sand and Rock Fragments of shale		Damp
				6.0		↓			
						BR	Sandy Clay - some Rock Fragments of Sandstone		RF < 2" φ, Moist
				9.0		↓			Auger to 10.0' refusal
						Red	Decomposed claystone		Damp, TOR 10.0'
						↓	weathered ^{to} claystone		
				12.5		↓			
						Gray	Siltstone Interbedded with Claystone/clayshale		
						Red			
				41.0		↓			
						Gray	Silt shale/Siltstone - trace Red seams of claystone		
				49.0		↓			
					Soft	Red	claystone		
				53.0		↓			
						Gray	interbedded silt shale + claystone		
				68.0		Red	claystone		
						Gray	Siltstone		Net cuttings lost
				70.0		↓			dust @ 58.0' water
						Gray	Sandstone		from hole by 62.0'
				78.5		↓			more water @ 71.0'
							Bottom @ 78.5'		
							Installation		Materials
							Sand 78.5 to 78.0', 20'		4 Bags Sand
							Screen 78.0 to 58.0', Sand		1/2 bucket pellets
							78.0 to 53', Bentonite to		2 bags Volclay grout
							49.0', Volclay grout to 3'		10 Bags Concrete mix
							Concrete to 0.0, 6" φ Pad		6"x5' Steel Casing
							PVC stickup 1.6, Steel 2.1		

REMARKS ** 4 1/4" ID HSA to 10.0', 4" φ Air Rotary 10.0' to 78.5', Simco 4000-T2 Track Rig
Doug Novotny Driller, Terra Testing.

* POCKET PENETROMETER READINGS
** METHOD OF ADVANCING AND CLEANING BORING

BORING NO. 0532 (mw-4)

N 542305.96
E 1753080.68

Grade El. 674.84 Top of PVC Riser El. 676.84



PROJECT Area 2/3 John E

BORING NO. 0533 (mw-5)

ELEVATION _____ GWL 0 HRS Dry

PROJECT NO. C040384.40.01

DATE 7-7-05 24 HRS 8.6'

CLASSIFIED BY TR. Gower

PAGE 1 of 1

DEPTH (FT.)	BLOWS PER SIX INCHES OR CORE RECOVERY/RUN	SAMPLE NO., TYPE & RECOVERY OR % ROCK RECOVERY	RQD (%) OR TORVANE	DESCRIPTION				USCS OR ROCK BROKENNESS	REMARKS*
				PROFILE	SOIL DENSITY - CONSISTENCY OR ROCK HARDNESS	COLOR	MATERIAL CLASSIFICATION		
1	2	3	4	5	6	7	8	9	10
						BR	Sandy Silt		Damp
				3.0		↓	↓		
						BR	Sand and Rock Fragments		Damp
				6.0		↓	↓		
						BR	Sandy Clay and Rock Fragments		Moist
				9.0		↓			
				10.2		Red	Decomposed claystone		Dry
							Bottom @ 10.2'		
							Installation:		Material
							3" sand to 10.0'		4 Bag Sand
							5' screen w/cap 10.0'-5.0'		1/2 Bucket Pellets
							Sand 10.0 to 4.0'		10 Bags Concrete Mix
							Bentonite Pellets 4.0'-3.0'		6"x5' Steel Casing
							Comment 3.0' - 0', 6" pad		
							2' stick up PVC		
							2.2' stick up steel casing		

REMARKS** 4 1/4" ID HSA to 10.2', Simco 4000-T2 Track Rig
Doug Novotny Driller, Terra Testing

* POCKET PENETROMETER READINGS
** METHOD OF ADVANCING AND CLEANING BORING

BORING NO. 0533 (mw-5)

N 540837.74
E 1754220.53

Grade El. 927.29 Top of PVC Riser El. 929.59



PROJECT Area 2/3 John E. Amos Power Plant

BORING NO. 0526 (mw 6)

ELEVATION _____ GWL 0 HRS 62.5' in well

PROJECT NO. CO40384.40.01

DATE 6-23-05 24 HRS 62.5'

CLASSIFIED BY TR Gower

PAGE 1 of 1

DEPTH (FT.)	BLOWS PER SIX INCHES OR CORE RECOVERY/RUN	CORE RECOVERY/RUN SAMPLE NO., TYPE & RECOVERY OR % ROCK RECOVERY	ROD (%) OR TORVANE	DESCRIPTION				USCS OR ROCK BROKENNESS	REMARKS*
				PROFILE	SOIL DENSITY - CONSISTENCY OR ROCK HARDNESS	COLOR	MATERIAL CLASSIFICATION		
1	2	3	4	5	6	7	8	9	10
						Red Brn.	Clayey Silt		Start 9:00 AM
				10.5		Yellow BR	Highly weathered siltstone to fine grain claystone		
				13.5		Lt Brn	Sandstone		Auger to 14'
				28.0		Gray	@ 25'		Air Hammer 14' to 91' 8'/10min in sandstone
				30.0		Gray	shale		
				36.0		Red	Claystone		
				38.0		Gray	Sand stone		
				76.0		Gray Red	Interbedded shale and siltstone / fine sandstone		Water encountered @ 76'
				91.0					End 11:30 AM
							Bottom of Boring @ 91.0'		
							Installation		Material
							Clean hole 11:30-12:25		
							Stabilize water @ 62.55' 2:00		
							Place bentonite pellets 91.0'		2 buckets bentonite
							to 78.5'; Sand 78.5' to 78.0'		4 50lbs bags sand
							Set 20' screen @ 78' to 58'		2 1/2 50lb bag volcay
							8" screen cap on end, stick up		10 Bags Concrete Mix
							2.3' Sand 78.0 to 55'		6" x 5" steel casing
							bentonite pellets 55' to 50'		
							Volcay grout to 4.0' 6-22-05		
							Concrete to surface, 2.5' steel stick		

REMARKS ** 4 1/4" ID Hollow Stem Augers to 14', 4" φ downhole hammer w/air to 91.0'

Simeco 4000-T2 Track Rig, Doug Novotny Driller, Terra Testing

* POCKET PENETROMETER READINGS

** METHOD OF ADVANCING AND CLEANING BORING

BORING NO. 0526 (mw-6)

N 539635.79
E 1755425.04

Grade El. 943.15 Top of PVC Riser El. 945.15



PROJECT Area 2/3 John E Amos Power plant

BORING NO. 0528 (mw-7)

ELEVATION _____ GWL 0 HRS 40.0

PROJECT NO. C040384.40.01

DATE 6-27-05 18 HRS 37.0

CLASSIFIED BY TR Gower

PAGE 1 of 1

DEPTH (FT.)	BLOWS PER SIX INCHES OR CORE RECOVERY/RUN	CORE RECOVERY/TYPE & SAMPLE NO., TYPE & RECOVERY OR % ROCK RECOVERY	RQD (%) OR TORVANE	DESCRIPTION				USCS OR ROCK BROKENNESS	REMARKS*
				PROFILE	SOIL DENSITY - CONSISTENCY OR ROCK HARDNESS	COLOR	MATERIAL CLASSIFICATION		
1	2	3	4	5	6	7	8	9	10
						BR	Silty Sand and Sandstone		Start 3:50 PM
				2.0		↓	Rock Fragments		Dry
				6.0		Yellow BR	Decomposed Sandstone		Dry
						↓			Auger Refusal @ 6.0'
						Gray BR	Sandstone		Dry
				22.0	Hard	Gray BR	18.0' to 22.0'		≈ 1 1/2 min
						BR	Siltstone		
						to Gray	↓		
						Red	from 24'		Water Encountered @ 40.0'
				55.5		Gray	↓		End 5:00 PM
						↓	Bottom @ 55.5'		Clean with air until 5:40 PM
							Installation		Materials
							Sand 55.5' to 52.0'		4 bag sand
							20' Screen 52.0 to 32.0'		1/4 bucket pellets
							Sand 52.0 to 30.0'		2 Bags Volclay
							Bentonite Pellets 20.0' to 28.0'		10 Bags Concrete
							Bucket of water on Pellets		6" φ steel casing
							Volclay Grout to 3.3', 3.3' of		5' total length
							Concrete. Pad 6' diameter		
							2' stickup PVC		
							2.5' stickup steel casing		

REMARKS ** 4 1/4" ID HSA to 6.0', 4" b Air Rotary w/hammer to 55.5'

Simco 4000-T2 Track Rig, Doug Novotny Driller, Terra Testing

* POCKET PENETROMETER READINGS

** METHOD OF ADVANCING AND CLEANING BORING

BORING NO. 0528 (mw-7)

N 542134.95
E 1756839.14

Grade El. 945.01 Top of PVC Riser El. 947.01



PROJECT Area 2/3 John E Amos Power Plant

BORING NO. 0534 (mw-8)

ELEVATION _____ GWL 0 HRS 19.8'

PROJECT NO. COYO 384.40.01

DATE 7-11-05 48 HRS 23.8'

CLASSIFIED BY T R Gower

PAGE 1 of 1

DEPTH (FT.)	BLOWS PER SIX INCHES OR CORE RECOVERY/RUN	CORE RECOVERY/TYPE & RECOVERY OR % ROCK RECOVERY	RQD (%) OR TORVANE	DESCRIPTION				USCS OR ROCK BROKENNESS	REMARKS*
				PROFILE	SOIL DENSITY - CONSISTENCY OR ROCK HARDNESS	COLOR	MATERIAL CLASSIFICATION		
1	2	3	4	5	6	7	8	9	10
				6.0		Red	Silty Clay		Start 11:00 AM moist
				9.0		Red	Decomposed Claystone		Dry
				23.0		Gray/BR	Sandy shale / sandstone Med Grain.		TOR 10.0' 10:30 air rotary
				26.0		Red	Claystone		Slight Hammering
				28.0		BR	Sandstone / sandy shale		
				37.0	Hard	Gray BR	Sandstone @ 37'		
				41.0		Red	Claystone		Moist @ top 6" Moist cuttings back
				60.5	Hard	Gray	Sandstone / sandy shale		2 1/2' of 41.0' Run
							Bottom @ 60.5'		End 12:35 PM
							Installation 60.5' to 60.0' Sand 3" cup on bottom 20' Screen Screen 60.0 to 40.0' Sand 60.0 to 30.0' Bentonite Pellets to 27.0' Volclay Grout to 3.0' Concrete 3.0 to 0.0', 6" pad 2' stick up of PVC 2.5' stick up of steel casing		Material: 20' screen, 2 caps 5 Bags Sand 1/4 Bucket Pellets 3 Bags Volclay 11 Bags Concrete Mix 6" x 5" Steel Casing

REMARKS... 4 1/4" ID Hollow Stem Augers to 10.0', 7" Air Rotary to 60.5', 4000-T2 Simco Track Rig, Doug Novotny Driller, Terra Testing

* POCKET PENETROMETER READINGS
** METHOD OF ADVANCING AND CLEANING BORING

BORING NO. 0534 (mw-8)

N 544221.98
E 1756158.78

Grade El. 933.39 Top of PVC Riser El. 935.39



PROJECT Area 2/3 John E Amos

BORING NO. 0530 (mw-9)

ELEVATION _____ GWL 0 HRS 47.4'

PROJECT NO. 0040384.40.01

DATE 6-30-05 24 HRS 30.2'

CLASSIFIED BY T.R. Gower

PAGE 1 of 1

DEPTH (FT.)	BLOWS PER SIX INCHES OR CORE RECOVERY/RUN	CORE RECOVERY/TYPE & SAMPLE NO., TYPE & RECOVERY OR % ROCK RECOVERY	RQD (%) OR TORVANE	DESCRIPTION				USCS OR ROCK BROKENNESS	REMARKS*
				PROFILE	SOIL DENSITY - CONSISTENCY OR ROCK HARDNESS	COLOR	MATERIAL CLASSIFICATION		
1	2	3	4	5	6	7	8	9	10
						Red	Silty Clay		Start 11:10 AM
				2.0			↓		Moist
				5.0		Red	Decomposed Claystone		Dry, Auger to 5.0'
							↓		Air Rotary 11:30
				15.0		Red trace gray	Claystone / clay shale		Hammer in claystone
							↓		Less @ 12'
				29.0	Hard	Gray	Fine grain Sandstone		
				31.0		BR	18 to 20'		
						BR	Sandy shale		
				35.0		Red	Claystone / clay shale		
							↓		
				44.0		Gray trace red	Siltstone w/sandstone seams / silt shale		
							Water Encountered @ 42'		Water encountered @ 42'
				51.0		Red	Claystone		
							↓		
				62.5	Hard	Gray	Sandstone		End Drilling 12:40 PM
							↓		
							Bottom @ 62.5'		Let sit 15 min blow out water 230 sec
							Installation		then dry, 15 min
							62.5 to 62.0' Sand		on 15 sec of water
							20' screen 62.0' to 42.0'		Add potable water to
							Sand 62.0' to 37.0'		clean hole 50 gal total
							Bentonite Pellets 37.0'-34.5'		Material
							Volclay grout to 3.0'		5 Bags Sand
							Concrete 3.0'-0.0' 6" Diameter		20' Screen
							Pad, 2' stick up PVC		1/4 bucket pellets
							2 1/2' stick up 6" φ steel		water added, 2 bags
							Casing 2.5' stick up		Volclay, 9 bags Concrete

REMARKS** 25 ft N345°W from Survey Pt. 307, 4 1/4" ID HSA to 5.0', 4" φ Air rotary w/hammer to Simco 4000-T2 Track Rig, Doug Novotny-Driller, Terra Testing

* POCKET PENETROMETER READINGS
** METHOD OF ADVANCING AND CLEANING BORING

BORING NO. 0530 (mw-9)

N 544019.11
E 1754183.58

Grade El. 909.43 Top of PVC Riser El. 911.43



PROJECT Area 2/3 John E Amos Power Station

BORING NO. 0531 (mw-10)

ELEVATION _____ GWL 0 HRS Dry

PROJECT NO. 040384.40.01

DATE 6-30-05 24 HRS 102'

CLASSIFIED BY T. R. Gower

PAGE 1 of 2

DEPTH (FT.)	BLOWS PER SIX INCHES OR CORE RECOVERY/RUN	CORE RECOVERY/RUN SAMPLE NO., TYPE & RECOVERY OR % ROCK RECOVERY	ROD (%) OR TORVANE	DESCRIPTION				USCS OR ROCK BROKENNESS	REMARKS*
				PROFILE	SOIL DENSITY - CONSISTENCY OR ROCK HARDNESS	COLOR	MATERIAL CLASSIFICATION		
1	2	3	4	5	6	7	8	9	10
				9.0		BR	Clayey Silt		Start 4:00.
						Red	Decomposed Claystone		Dry
				11.0		↓	weathered claystone		Auger to 10.0'
						Lt BR	Silty Shale / siltstone		
				20.0		↓			
						BR	Sandstone		
				26.0		↓			
						Lt Gray	Siltstone - Red @ 29.0'		
				34.0		↓	Gray @ 31.0'		
				36.0		Red	Claystone		
				40.5	Hard	Gray	Fine grain Sandstone		
						↓			
				46.0		Red Gray	Claystone		
				58.0		Gray	Siltstone		Stop 5:00 @ 52'
				60.0		Red	Claystone		
						Gray	Siltstone / v. Fine Grain		
				71.0		↓	Sandstone, shaly		
					Hard	Gray	Sandstone		
				76.0	↓	↓			
					Soft	Red	Siltstone / Claystone		
				81.0	↓	↓			
				82.0	Hard	Gray	Sandstone		
						Gray	Siltstone		
				84.0		↓			
					Hard	Gray	Sandstone / w/ 6" seams of softer siltstone		Stop @ 112' 11:05 AM
				125.0	↓	↓			
						Red	Claystone		
				138.0		↓			

REMARKS ** 4 1/4" ID Hollow Stem Augers to 10.0', 4" Air Rotary w/hammer 10.0' to 157.0'
Simco 4000-T2 Track Rig, Doug Novotny Driller, Terra Testing.

* POCKET PENETROMETER READINGS
** METHOD OF ADVANCING AND CLEANING BORING

BORING NO. 0531 (mw-10)

PROJECT Area 2/3 John E Amos Power Station

BORING NO. 0531 (mw-10)

ELEVATION _____ GWL 0 HRS Dry

PROJECT NO. 040384.40.01

DATE 7-1-05 24 HRS 102

CLASSIFIED BY T.R.Gower

PAGE 2 of 2

DEPTH (FT.)	BLOWS PER SIX INCHES OR CORE RECOVERY/RUN	SAMPLE NO., TYPE & RECOVERY OR % ROCK RECOVERY	RQD (%) OR TORVANE	DESCRIPTION				USCS OR ROCK BROKENNESS	REMARKS*
				PROFILE	SOIL DENSITY - CONSISTENCY OR ROCK HARDNESS	COLOR	MATERIAL CLASSIFICATION		
1	2	3	4	5	6	7	8	9	10
						Gray	Siltstone		Dry
				149.0		↓	↓		
						Gray	Sandstone		
				152.0		↓	↓		
						Red	Claystone		
				153.0					
						DK Gray	Sandstone w/mica grains		
				154.0		Gray	Siltstone		
						↓	↓		
				157.0					End 12:05 PM
							Bottom @ 157.0'		
							Installation		Material
							Hole measured @ 154.0'		11 bags sand
							Sand to 153.0'; 20' screen		1/4 bucket pellets
							153.0' to 133.0'; Sand		4 1/2 bags vol clay
							153.0 to 85.0'; bentonite pellets to 81.0'; vol clay to 3.5'; Concrete 3.5 to 0.0'		10 Bags Concrete MIX
							6" φ x 5' steel casing, 6' diameter pad		6" φ x 5' steel casing
							2' stick up PVC		
							2.5' stick up steel casing		

REMARKS **

* POCKET PENETROMETER READINGS

** METHOD OF ADVANCING AND CLEANING BORING

Definition of Terms Used to Describe Subsurface Materials

SOILS

DENSITY OF GRANULAR SOILS BASED ON STANDARD PENETRATION RESISTANCE

DESIGNATION	STANDARD PENETRATION RESISTANCE (BLOWS/FOOT)
VERY LOOSE	0 - 4
LOOSE	5 - 10
MEDIUM DENSE	11 - 30
DENSE	31 - 50
VERY DENSE	OVER 50

CONSISTENCY OF COHESIVE SOILS IS BASED ON FIELD AND/OR LABORATORY TESTS

CONSISTENCY	UNC. COMPRESSIVE STR. (TONS PER SQUARE FOOT)	FIELD IDENTIFICATION
VERY SOFT	LESS THAN 0.25	EASILY PENETRATED SEVERAL INCHES BY FIST
SOFT	0.25 TO 0.50	EASILY PENETRATED SEVERAL INCHES BY THUMB
MEDIUM STIFF	0.50 TO 1.0	CAN BE PENETRATED SEVERAL INCHES BY THUMB WITH MODERATE EFFORT
STIFF	1.0 TO 2.0	READILY INDENTED BY THUMB BUT PENETRATED ONLY WITH GREAT EFFORT
VERY STIFF	2.0 TO 4.0	READILY INDENTED BY THUMBNAIL
HARD	MORE THAN 4.0	INDENTED WITH DIFFICULT BY THUMBNAIL

ADDITIONAL TERMS USED IN THE DESCRIPTION OF SOILS:

AND	INDICATES APPROXIMATELY EQUAL AMOUNTS OF MATERIALS, SUCH AS A SAND AND GRAVEL MIXTURE. IF THE MATERIALS OCCUR IN THIN SEPARATE SEAMS, IT IS NOTED IN THE DETAILED WORD CLASSIFICATION. THE THICKNESS IS GIVEN WHERE POSSIBLE.
SOME	INDICATES A SIGNIFICANT AMOUNT OF THE ACCESSORY MATERIAL. EXAMPLE: MEDIUM DENSE SILTY SAND - SOME GRAVEL
TRACE	INDICATES A MINOR AMOUNT OF THE ACCESSORY MATERIAL. EXAMPLE: LOOSE SILTY SAND - TRACE OF GRAVEL
INTERBEDDED	USED TO DESCRIBE THIN ALTERNATING SEAMS. THICKNESS IS GIVEN WHERE POSSIBLE EXAMPLE: HARD INTERBEDDED SILT AND CLAY (APPROXIMATELY 1/16" THICK)

ROCK

TERM	DEFINITION
SEAM	THIN (12 INCHES OR LESS) PROBABLY CONTINUOUS LAYER
SOME	INDICATES SIGNIFICANT (15 TO 40 PERCENT) AMOUNTS OF THE ACCESSORY MATERIAL. EXAMPLE: ROCK COMPOSED OF SANDSTONE (70%) AND SEAMS OF SHALE (30%) WOULD BE: SANDSTONE - SOME SHALE SEAMS
FEW	INDICATES MINOR (0-15 PERCENT) AMOUNTS OF THE ACCESSORY MATERIAL. EXAMPLE: ROCK COMPOSED OF SANDSTONE (90%) AND SEAMS OF SHALE (10%) WOULD BE: SANDSTONE - FEW SHALE SEAMS
INTERBEDDED	USED TO INDICATE THIN OR VERY THIN ALTERNATING SEAMS OF MATERIAL OCCURRING IN APPROXIMATELY EQUAL AMOUNTS EXAMPLE: ROCK COMPOSED OF SANDSTONE (50%) AND SHALE (50%) SEAMS WOULD BE INTERBEDDED SANDSTONE AND SHALE.

THE DEGREE OF BROKENNESS OF THE ROCK IS DESCRIBED BY ONE OF THE FOLLOWING TERMS:























DESCRIPTIVE TERMS	ABBREVIATION	SPACING
VERY BROKEN	(V. BR.)	LESS THAN 2 INCHES
BROKEN	(BR.)	2 INCHES - 1 FOOT
BLOCKY	(BL.)	1 FOOT - 3 FEET
MASSIVE	(M.)	3 FEET - 10 FEET

ROD-ROCK QUALITY DESIGNATION IS CUMULATIVE LENGTH OF PIECES OF CORE EQUAL TO OR GREATER THAN FOUR INCHES IN LENGTH DIVIDED BY THE TOTAL LENGTH OF CORE RUN, EXPRESSED AS A PERCENTAGE.

THE FOLLOWING BASIC NAMES ARE APPLIED TO SEDIMENTARY ROCK:

ROCK TYPE	CHARACTERISTICS
SANDSTONE	MADE UP PREDOMINANTLY OF GRANULAR MATERIALS RANGING BETWEEN 1/16 AND 2MM IN DIAMETER
SILTSTONE	MADE UP OF GRANULAR MATERIALS LESS THAN 1/16 MM IN DIAMETER. FRACTURES IRREGULARLY, MEDIUM THICK TO THICK BEDDED
CLAYSTONE	VERY FINE GRAINED ROCK MADE UP OF CLAY MATERIALS. FRACTURES IRREGULARLY, VERY SMOOTH TO TOUCH. GENERALLY HAS IRREGULARLY SPACED PITTING ON SURFACE OF DRILLED CORES.
SHALE	A FISSILE VERY FINE GRAINED ROCK. FRACTURES ALONG BEDDING PLANES
LIMESTONE	ROCK MADE UP PREDOMINANTLY OF CALCITES (CA CO3) EFFERVESCES UPON THE APPLICATION OF HYDROCHLORIC ACID
COAL	ROCK CONSISTING MAINLY OF ORGANIC REMAINS

LEGEND

 RESIDUAL SOIL	 CLAYSTONE	 2" O.D. SPLIT BARREL SAMPLE
 GRAVEL	 LIMESTONE	 CASING SAMPLE
 SAND OR ALLUVIUM	 SILTSTONE	 ST-1 SAMPLE NUMBER 3" DIA. UNDISTURBED SAMPLE
 SILT	 SANDSTONE	 4.6 5.0 LENGTH OF CORE RECOVERED LENGTH OF DRILL RUN
 CLAY	 SHALE	 3-10-66 GROUND WATER LEVEL AND DATE OF OBSERVATION
 ORGANIC MATERIAL	 CONCRETE	 60/0.3 INDICATES 60 BLOWS REQUIRED FOR SPLIT BARREL TO PENETRATE 0.3 FEET
 SLAG	 COAL	 APPROXIMATE TOP OF ROCK
 FILL	 VOID	



GAI Consultants, Inc. 2006

Well Construction Diagrams

B-0501 to B-0515, B-0517, B-0519 to B-0525 & MW-1 to MW-10

MONITORING WELL CONSTRUCTION DIAGRAM
(Not to Scale)

Project AREA 2/3 JOHN E. AMOS POWER PLANT

Project No. C040384.40-01

Date 21 APR 2005

Engineer/Geologist DRS

Well No. B-0501

N 540558.4978
E 172508.1269
NAD 83 WV SOUTH

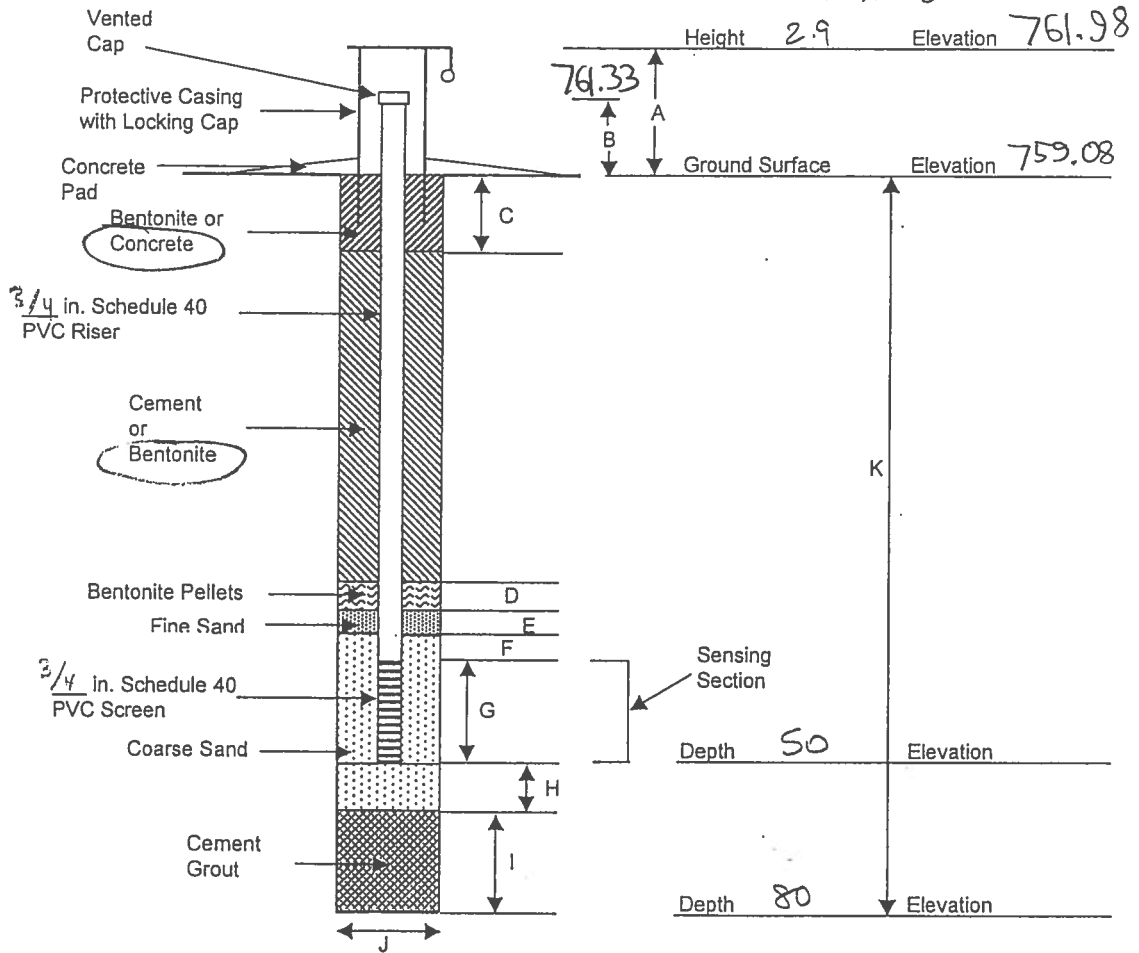

STANDPIPE PIEZOMETER INSTALLATION SKETCH

DIMENSIONS (Feet)					
A	B	C	D	E	F
2.9	2.25	35	0	0	5
G	H	I	J	K	
10	3	30	0.25	80.0	

Remarks _____

MONITORING WELL CONSTRUCTION DIAGRAM
(Not to Scale)

Project AREA 2/3 JOHN E. AMOS POWER PLANT Project No. CO40384.40-01
Date 21 APR 2005 Engineer/Geologist DBS Well No. B0502

N 540563.2422
E 1723508.0316
MAD 83 WV SOLT

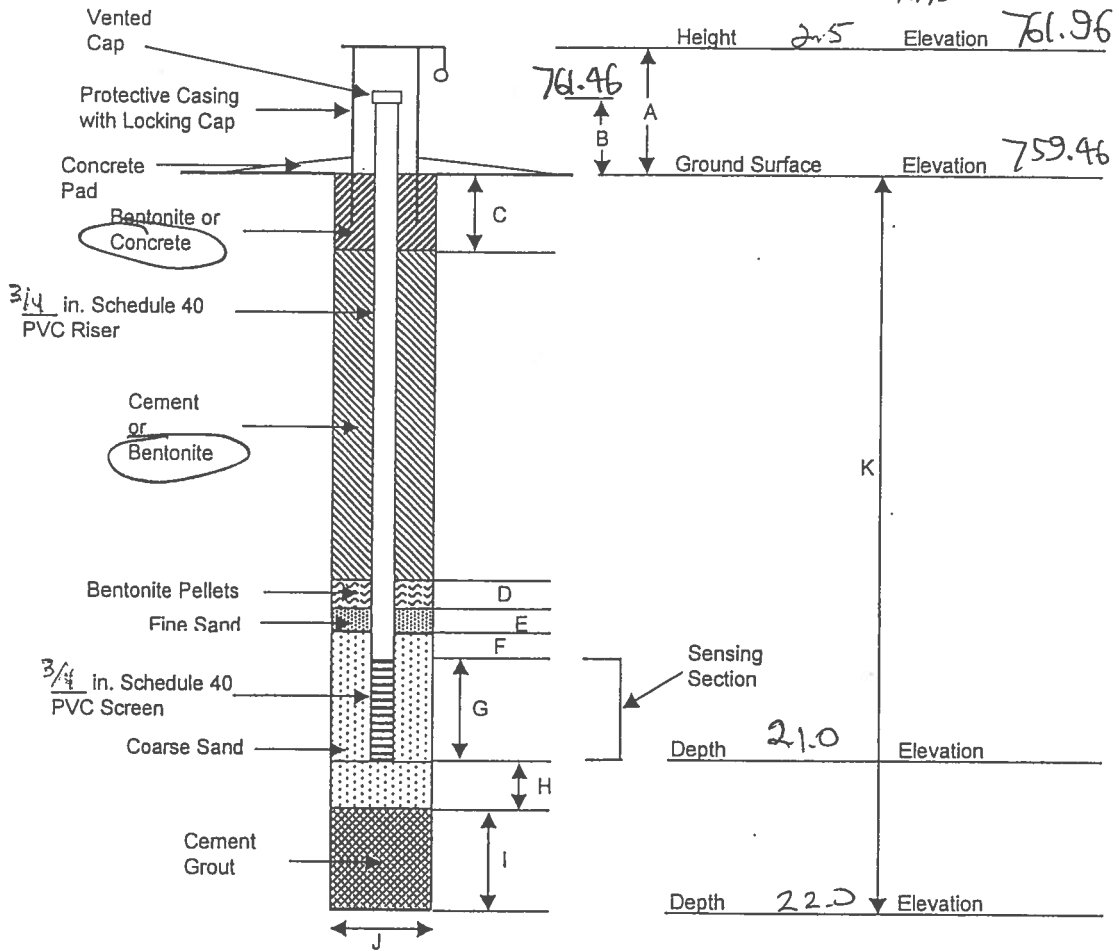

STANDPIPE PIEZOMETER INSTALLATION SKETCH

DIMENSIONS (Feet)					
A	B	C	D	E	F
2.5	2.0	7.0	0	0	4
G	H	I	J	K	
10	1	0	0.25	22.0	

Remarks _____

MONITORING WELL CONSTRUCTION DIAGRAM
(Not to Scale)

Project AREA 2/3 AMOS POWER PLANT

Project No. C040324.40-01

Date 20 APR 2005

Engineer/Geologist DRS

Well No. 0503

N 540843.8055
E 1723858.5630
NAD 83 W W SOUTH

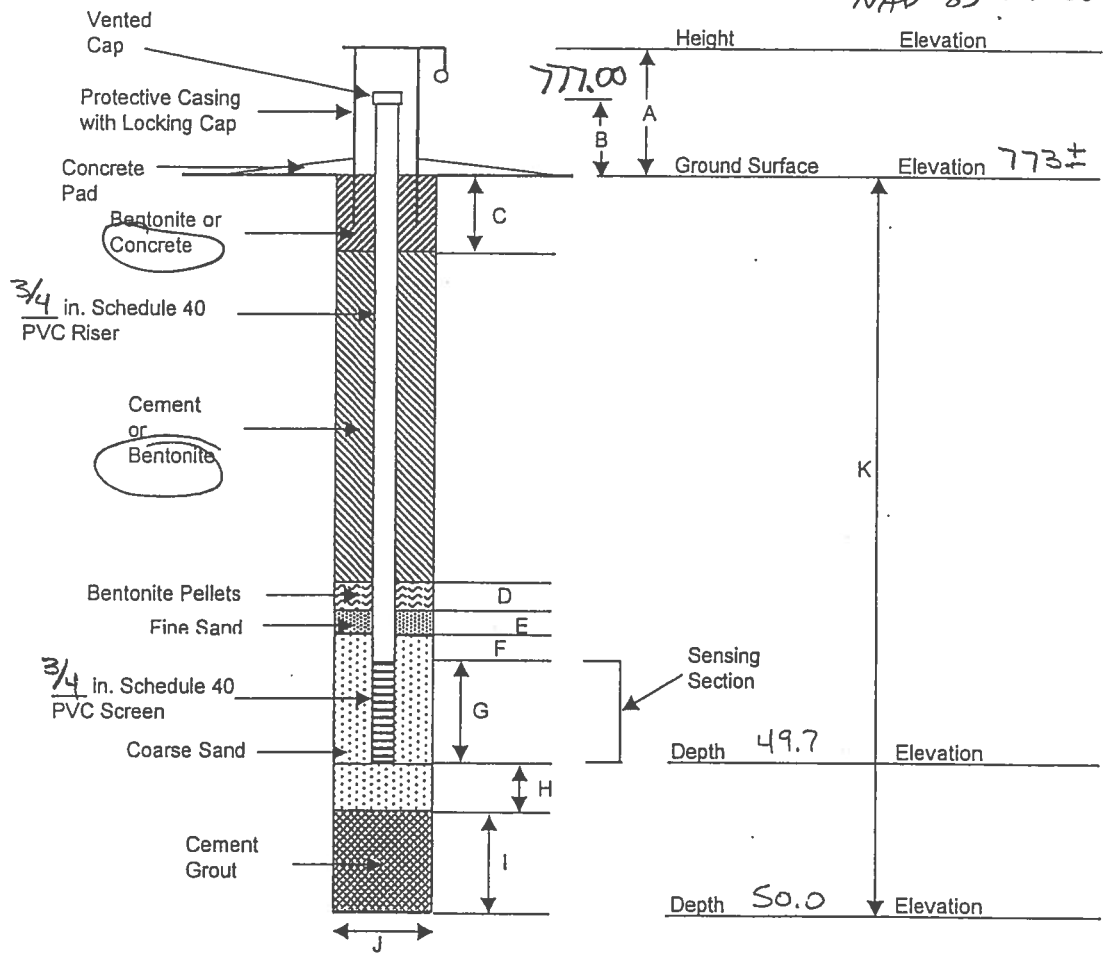

STANDPIPE PIEZOMETER INSTALLATION SKETCH

DIMENSIONS (Feet)					
A	B	C	D	E	F
2.6	2.0	34.7	0	0	5
G	H	I	J	K	
10	0.3	0	0.25	50.0	

Remarks _____

MONITORING WELL CONSTRUCTION DIAGRAM
(Not to Scale)

Project AREA 2/3 JOHN E. AMOS POWER PLANT

Project No. CD40384.40-01

Date 20 APR 2005

Engineer/Geologist DBS

Well No. B 0504

N 540840.0544
E 1723859.8367

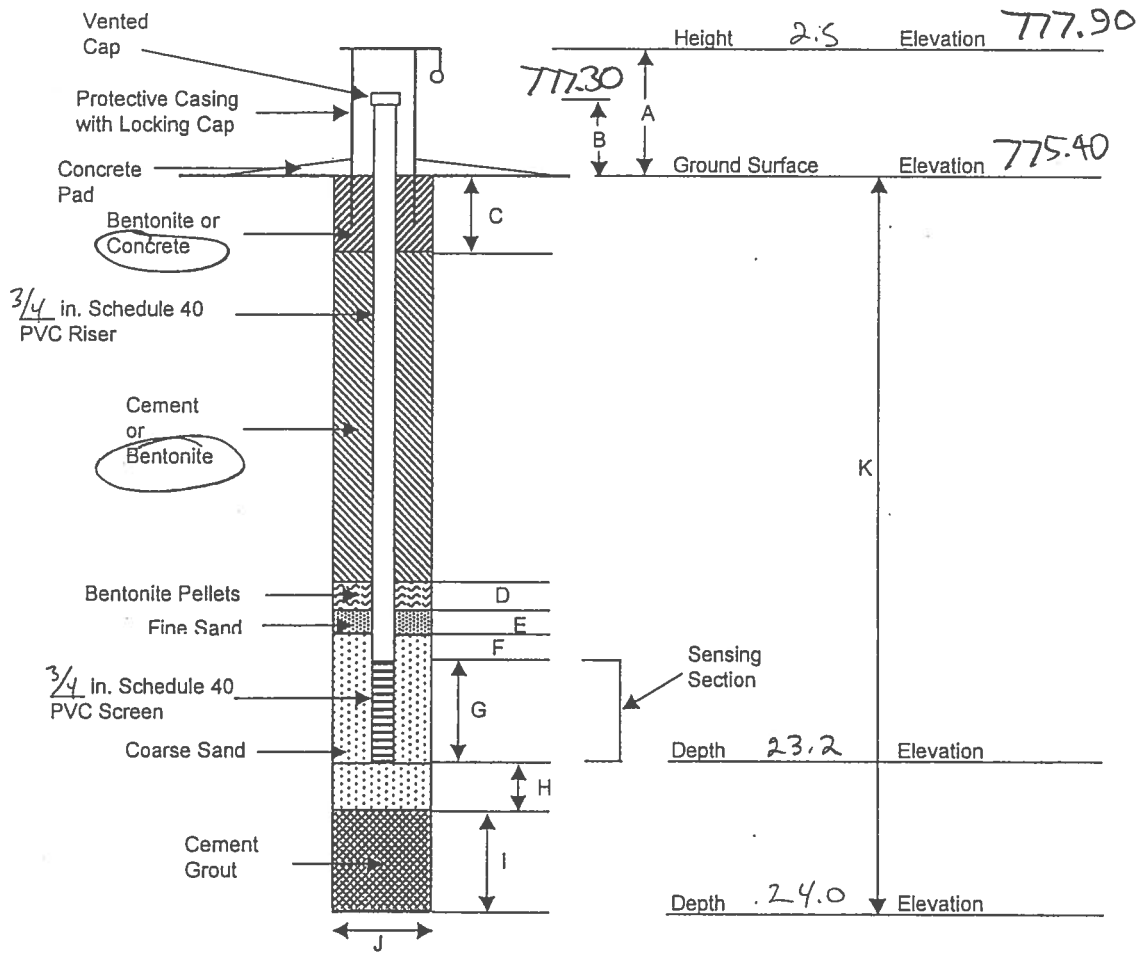

STANDPIPE PIÉZOMETER INSTALLATION SKETCH

DIMENSIONS (Feet)					
A	B	C	D	E	F
2.5	1.9	8.2	0	0	5
G	H	I	J	K	
10	0.8	0	0.25	24.0	

Remarks _____

MONITORING WELL CONSTRUCTION DIAGRAM
(Not to Scale)

Project AREA 2/3 JOHN E. AMOS POWER PLANT

Project No. C040384.40-01

Date 27 APR 2005

Engineer/Geologist DPAS

Well No. B 0505
(27)

N 541325.3505
E 1723551.3362

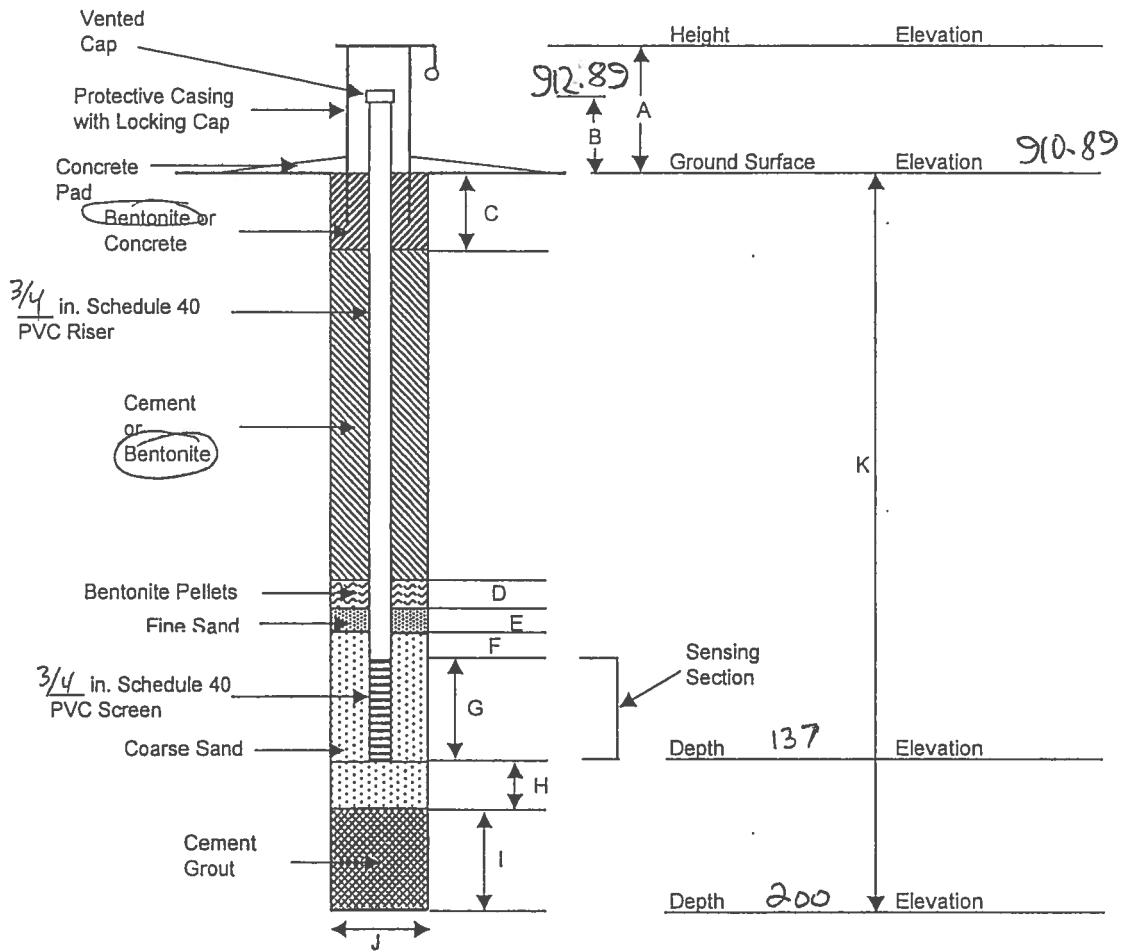

STANDPIPE PIEZOMETER INSTALLATION SKETCH

DIMENSIONS (Feet)					
A	B	C	D	E	F
2.5	2.0	1.0	0	0	137
G	H	I	J	K	
20	3	60	0.25	200	

Remarks _____

MONITORING WELL CONSTRUCTION DIAGRAM
(Not to Scale)

Project AREA 2/3 AMOS POWER PLANT

Project No. C040384.40-01

Date 28 APR 2005

Engineer/Geologist DBS

Well No. B0506

N 539424.9688

E 1722518.6810

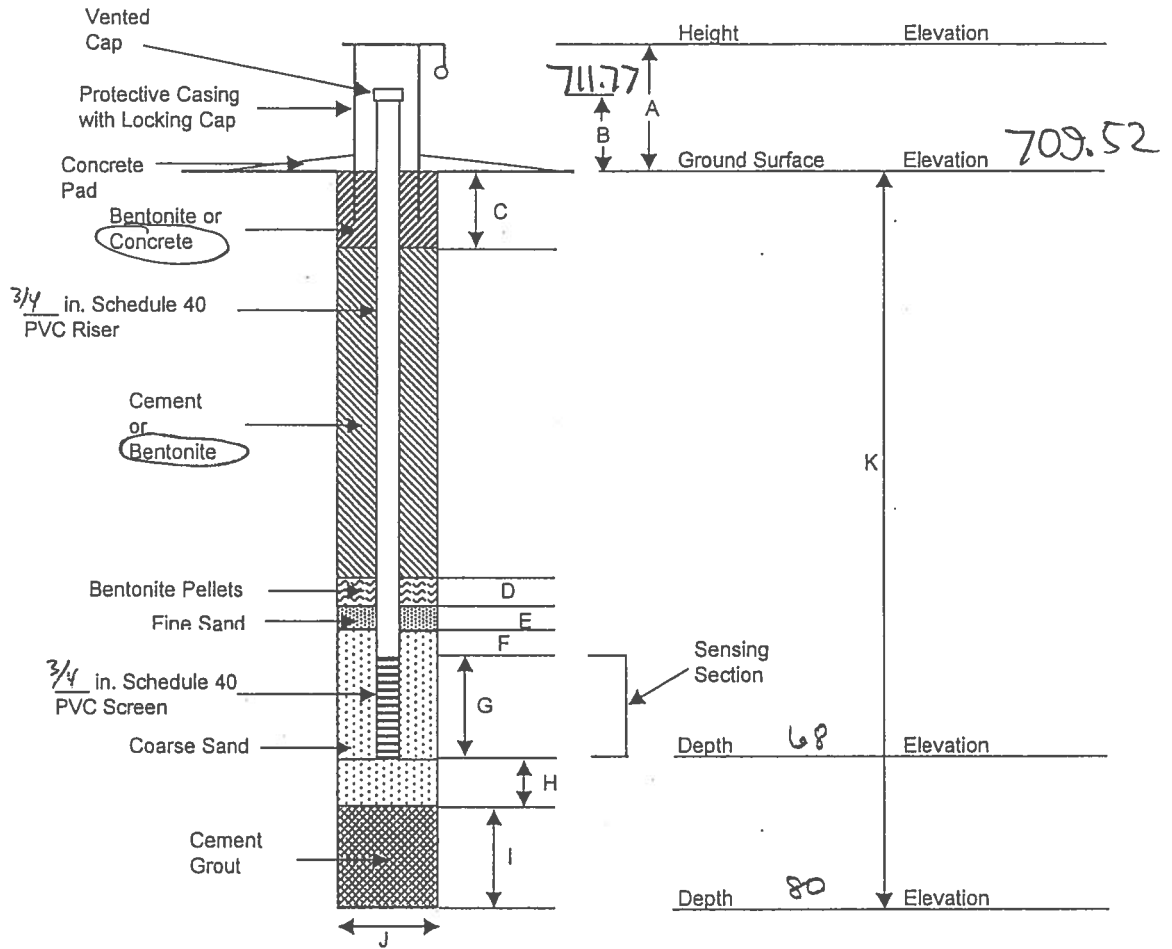

STANDPIPE PIEZOMETER INSTALLATION SKETCH

DIMENSIONS (Feet)					
A	B	C	D	E	F
2.55	2.25	20	0	0	38
G	H	I	J	K	
10	2	10	0.25	80	

Remarks _____

MONITORING WELL CONSTRUCTION DIAGRAM
(Not to Scale)

Project AREA 2/3 JOHN E. AMOS POWER PLANT

Project No. COY0384.40-01

Date 22 APR 2005

Engineer/Geologist DBS

Well No. B0507

N 539428.8146

E 172523.7682

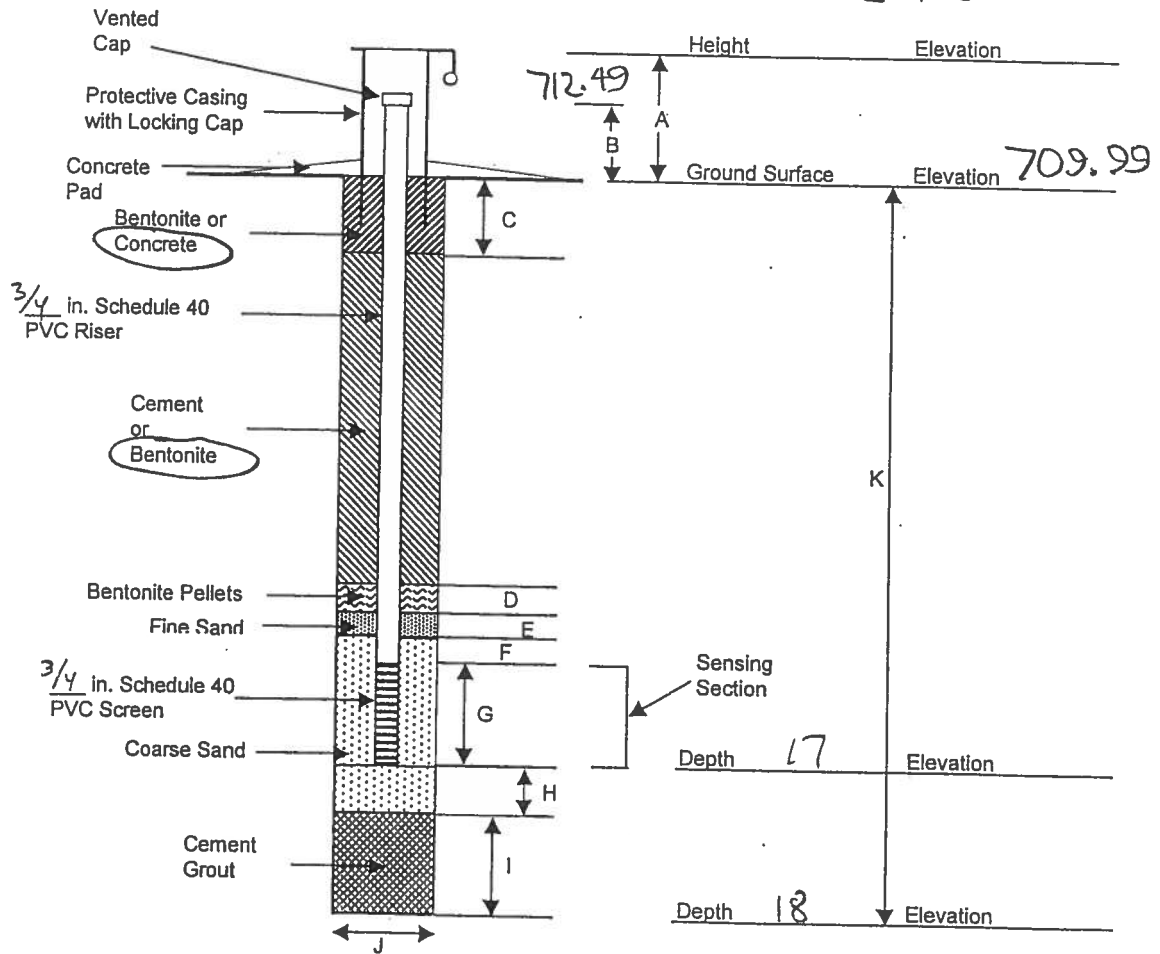

STANDPIPE PIEZOMETER INSTALLATION SKETCH

DIMENSIONS (Feet)					
A	B	C	D	E	F
2.75	2.50	4	0	0	3
G	H	I	J	K	
10	1	0	0.25	18	

Remarks _____

MONITORING WELL CONSTRUCTION DIAGRAM
(Not to Scale)

Project AREA 2/3 AMOS POWER PLANT

Project No. C040384.43-01

Date 03 MAY 2005

Engineer/Geologist JBC

Well No. B-0508

N 541 996. 9754

E 1723377.3436

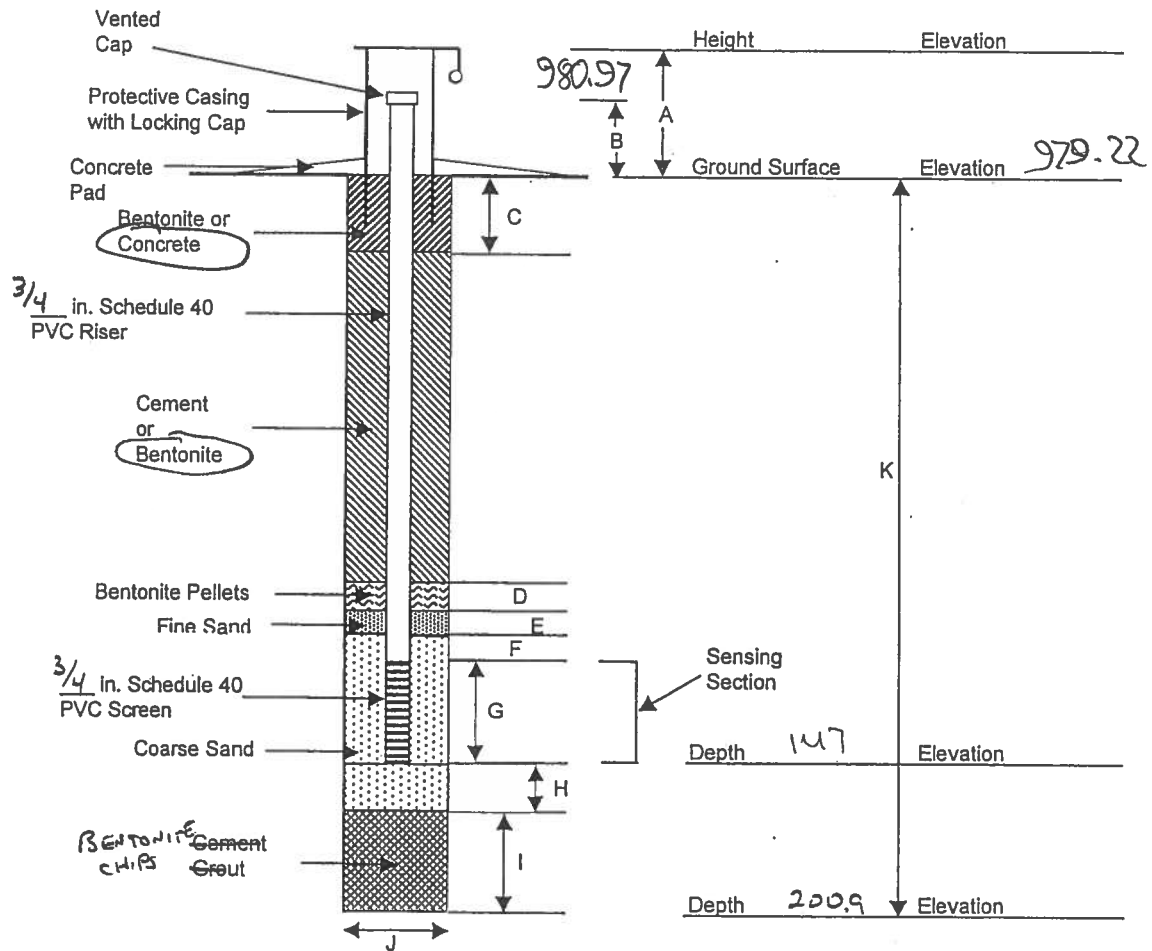

STANDPIPE PIEZOMETER INSTALLATION SKETCH

DIMENSIONS (Feet)					
A	B	C	D	E	F
2.5	1.75	77	—	—	50.
G	H	I	J	K	
20	3	50.9	0.25	200.9	

Remarks _____

MONITORING WELL CONSTRUCTION DIAGRAM
(Not to Scale)

Project AREA 2/3 AMOS POWER PLANT

Project No. C040384.40-01

Date 03 MAY 2005

Engineer/Geologist DBS

Well No. B-2509

N 541748.6664
E 172411.6219

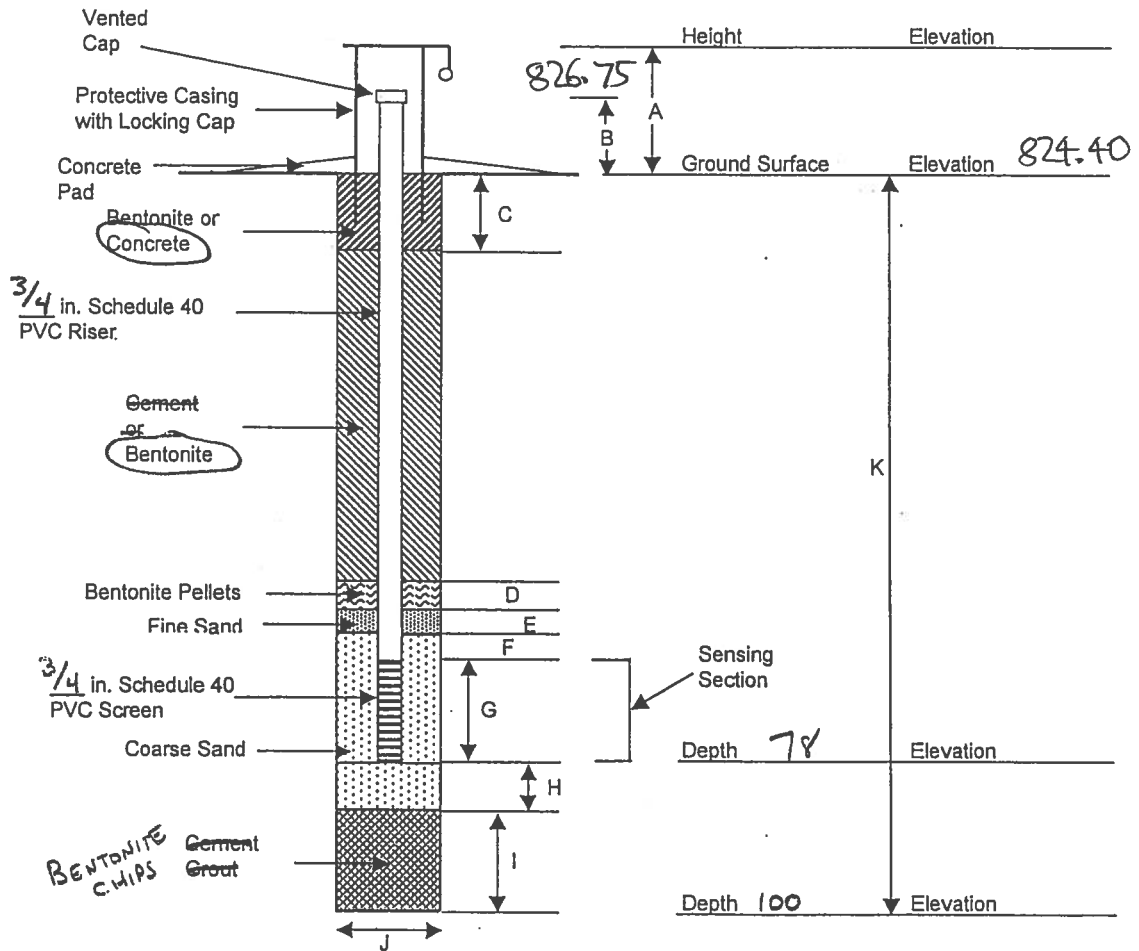

STANDPIPE PIEZOMETER INSTALLATION SKETCH

DIMENSIONS (Feet)					
A	B	C	D	E	F
2-6	2.35	20	—	—	48
G	H	I	J	K	
10	2.0	20	0.25	100	

Remarks _____

MONITORING WELL CONSTRUCTION DIAGRAM
(Not to Scale)

Project AREA 2/3 AMOS POWER PLANT

Project No. C040384.40-01

Date 10 MAY 2005

Engineer/Geologist DBS

Well No. B-0510

~~(24)~~
N. 540879. 8326
E 1722795. 6504

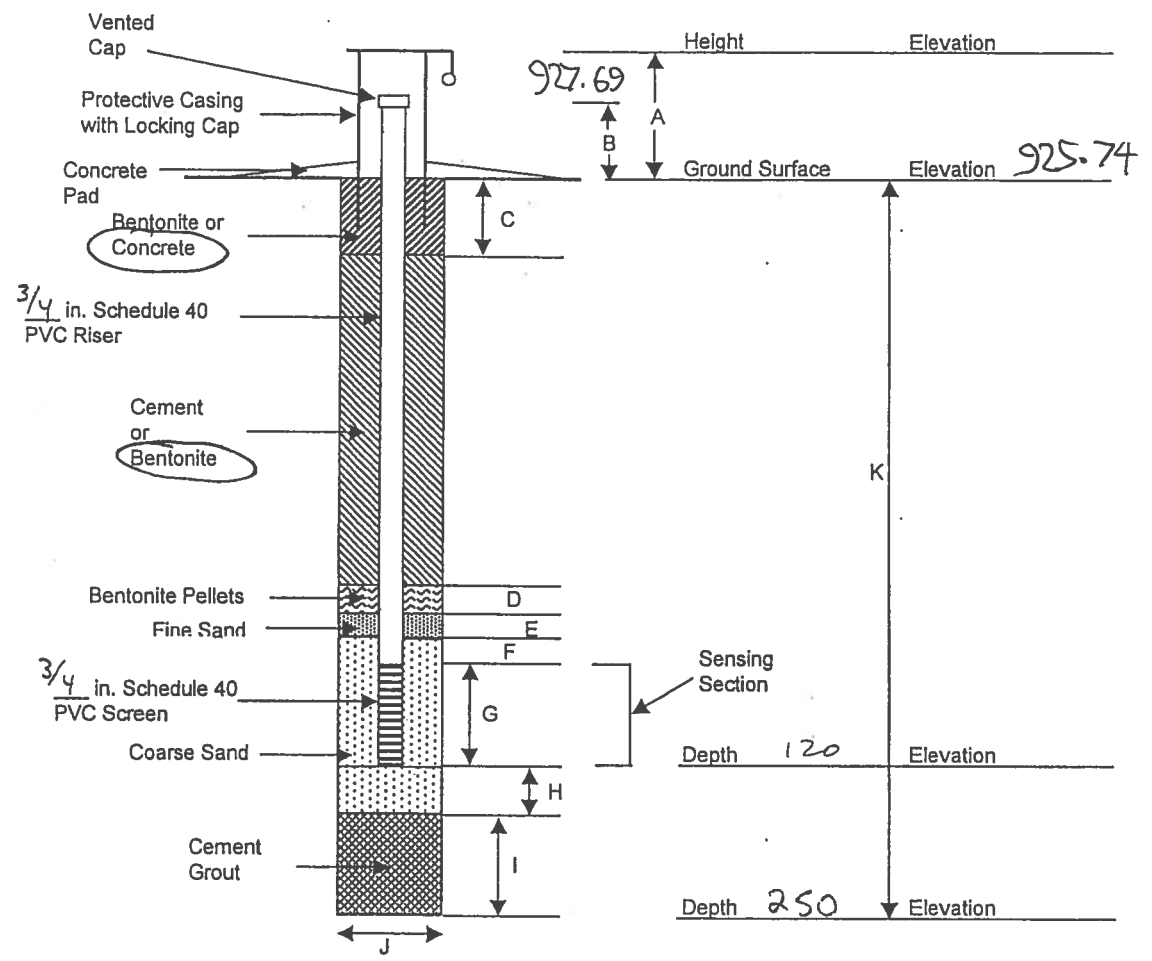

STANDPIPE PIEZOMETER INSTALLATION SKETCH

DIMENSIONS (Feet)					
A	B	C	D	E	F
2.6	1.95	30	-	-	70
G	H	I	J	K	
20	2	128.7	0.25	250.7	

Remarks _____

MONITORING WELL CONSTRUCTION DIAGRAM
(Not to Scale)

Project AREA 73, JOHN E. AMOS POWER PLANT

Project No. CO40324.45-01

Date 04 MAY 2005

Engineer/Geologist DBS

Well No. B-0511

N 541746.9425
E 1724116.3536

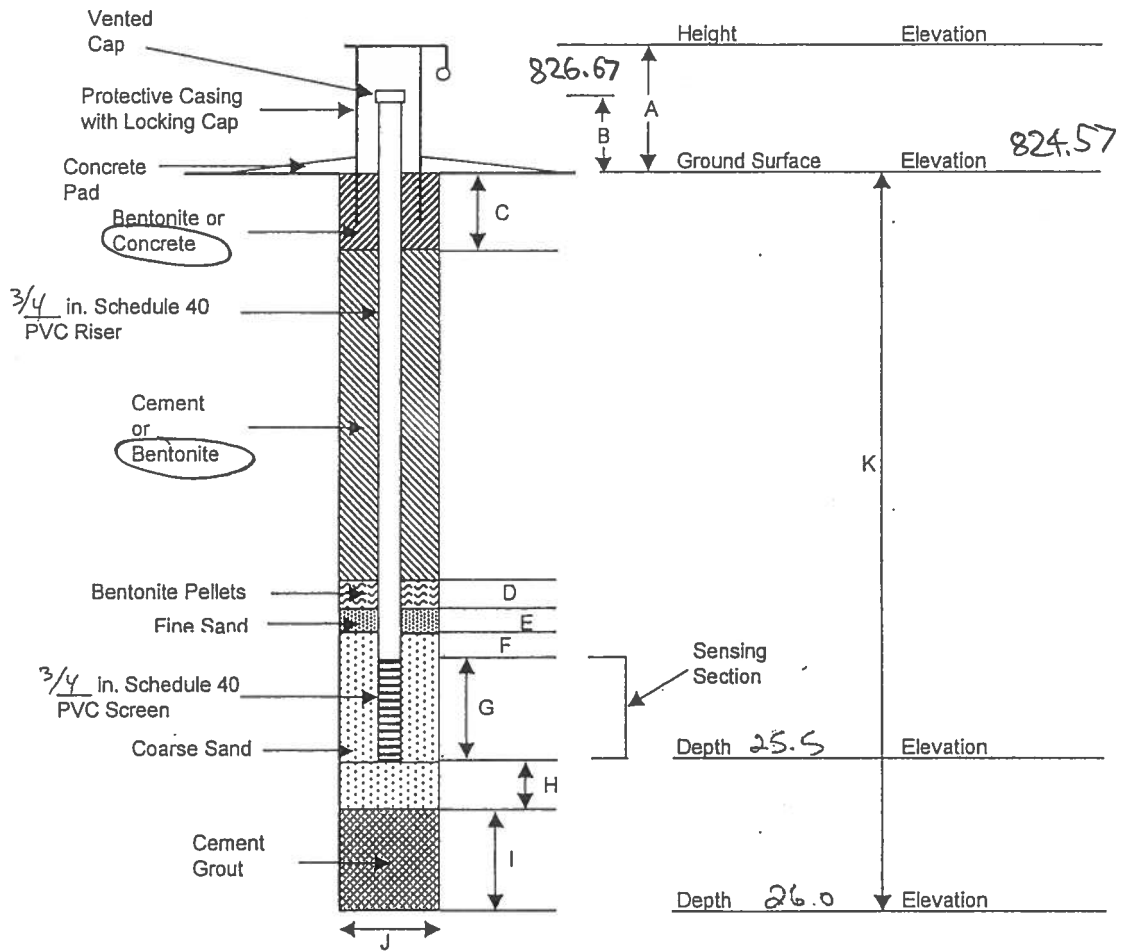

STANDPIPE PIEZOMETER INSTALLATION SKETCH

DIMENSIONS (Feet)					
A	B	C	D	E	F
2.45	2.1	3.5	—	—	12.0
G	H	I	J	K	
10	0.5	—	0.25	26.0	

Remarks _____

MONITORING WELL CONSTRUCTION DIAGRAM
(Not to Scale)

Project AREA 2/3 AMOS POWER PLANT

Project No. C040324.43-01

Date 06 MAY 2005

Engineer/Geologist DBS

Well No. B-0512

N 542140.8876
E 1724101.7636

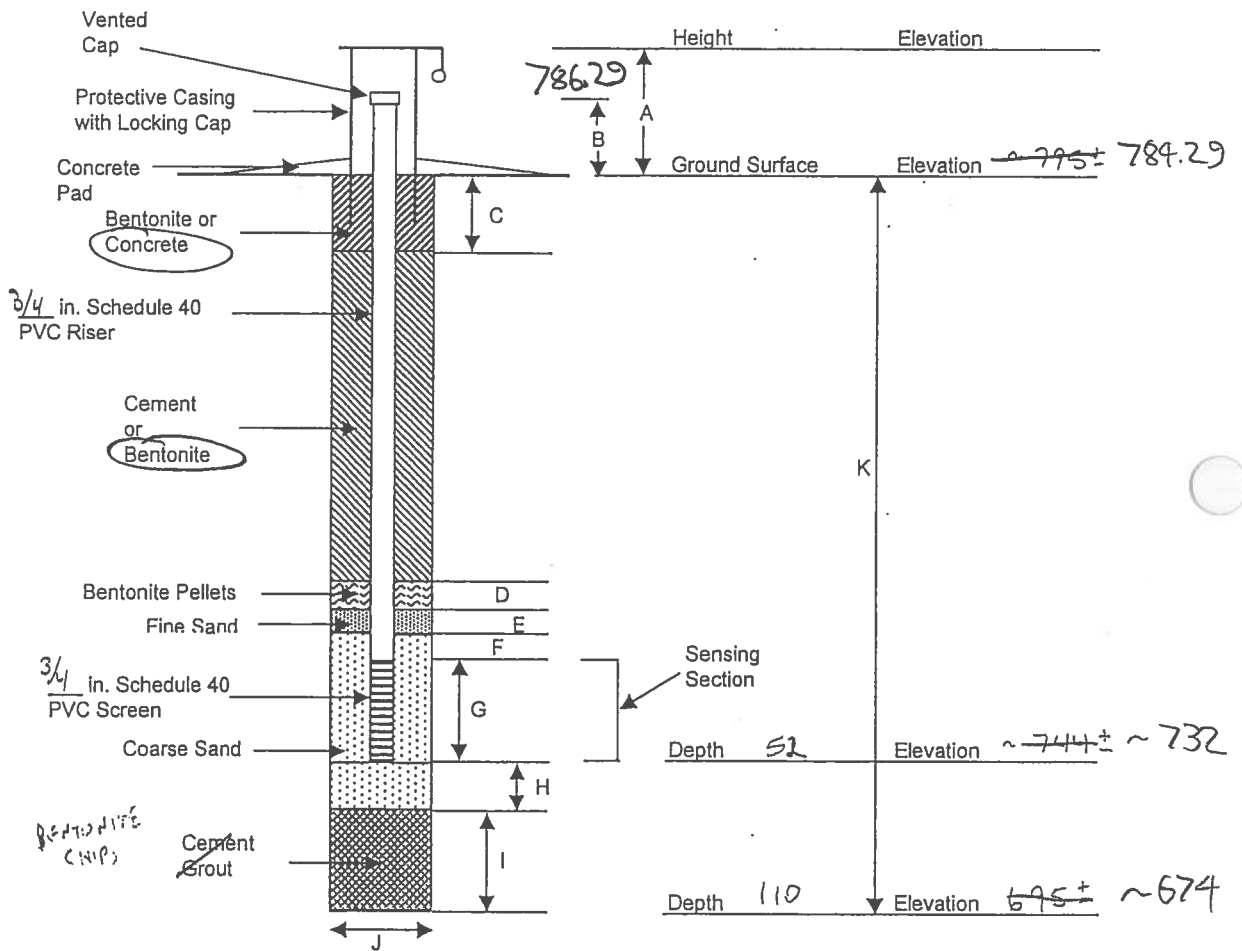

STANDPIPE PIEZOMETER INSTALLATION SKETCH

DIMENSIONS (Feet)					
A	B	C	D	E	F
2.6	2.0	20.0	—	—	22.0
G	H	I	J	K	
10	2	56	0.25	110	

Remarks PIEZOMETER B-0513 INSTALLED
IN SAME BORE HOLE (TIP AT 14 FT)

MONITORING WELL CONSTRUCTION DIAGRAM
(Not to Scale)

Project AREA 2/3 AMOS POWER PLANT Project No. C040384.40-01
 Date 06 MAY 2005 Engineer/Geologist DBS Well No. B-0513
 N 542140. 8876
 E 174101. 7636

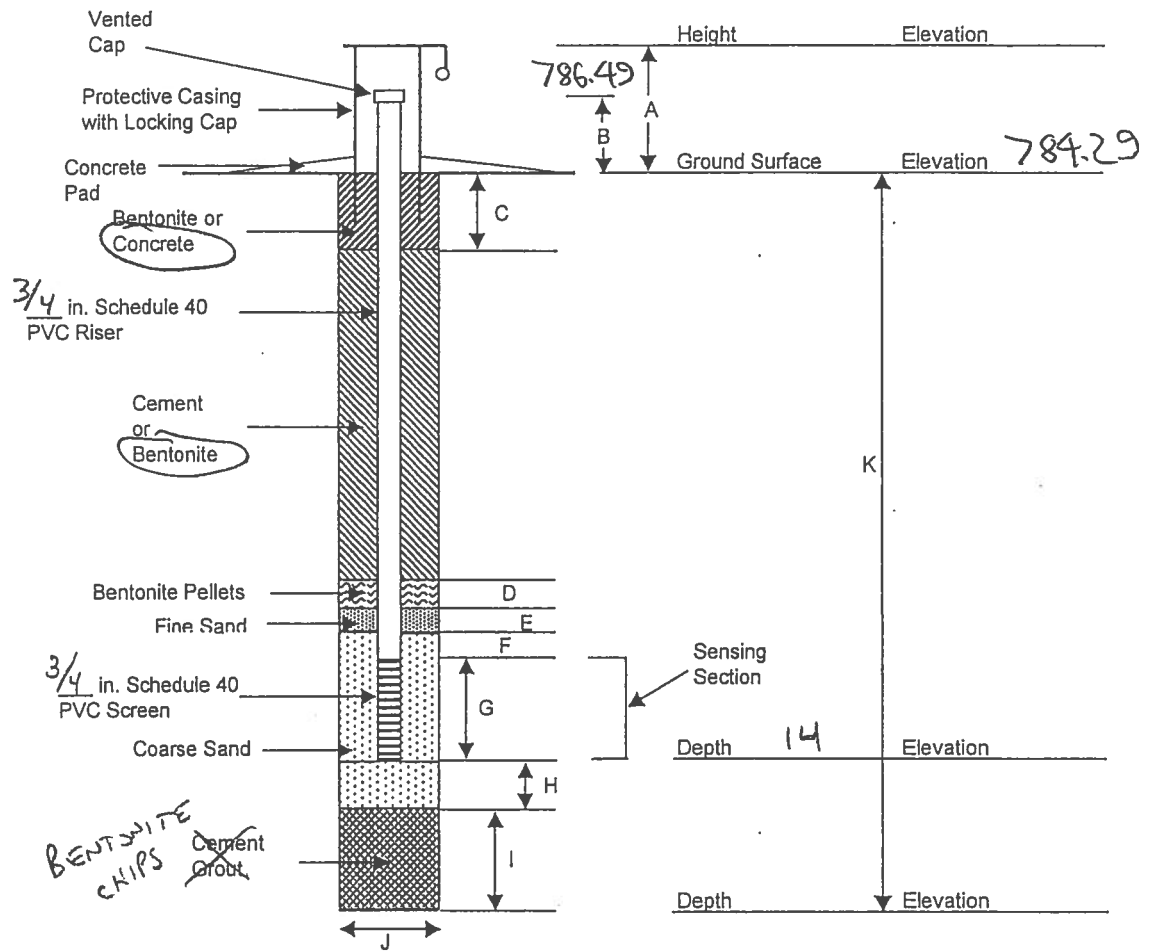

STANDPIPE PIEZOMETER INSTALLATION SKETCH

DIMENSIONS (Feet)					
A	B	C	D	E	F
2.6	2.2	3	-	-	1.5
G	H	I	J	K	
10	2	3**	0.25	*	

Remarks * NOTE: PIEZOMETER INSTALLED
IN SAME BORE HOLE AS B-0512
** 2 FT SEAL BETWEEN SAND PACK FOR B-0512 AND
SAND PACK FOR B-0513

MONITORING WELL CONSTRUCTION DIAGRAM
(Not to Scale)

Project AREA 2/3 AMWS POWER PLANT

Project No. C040384.40-01

Date 12 MAY 2005

Engineer/Geologist DBS

Well No. B-0514

N 540555.6419
E 1725145.9412

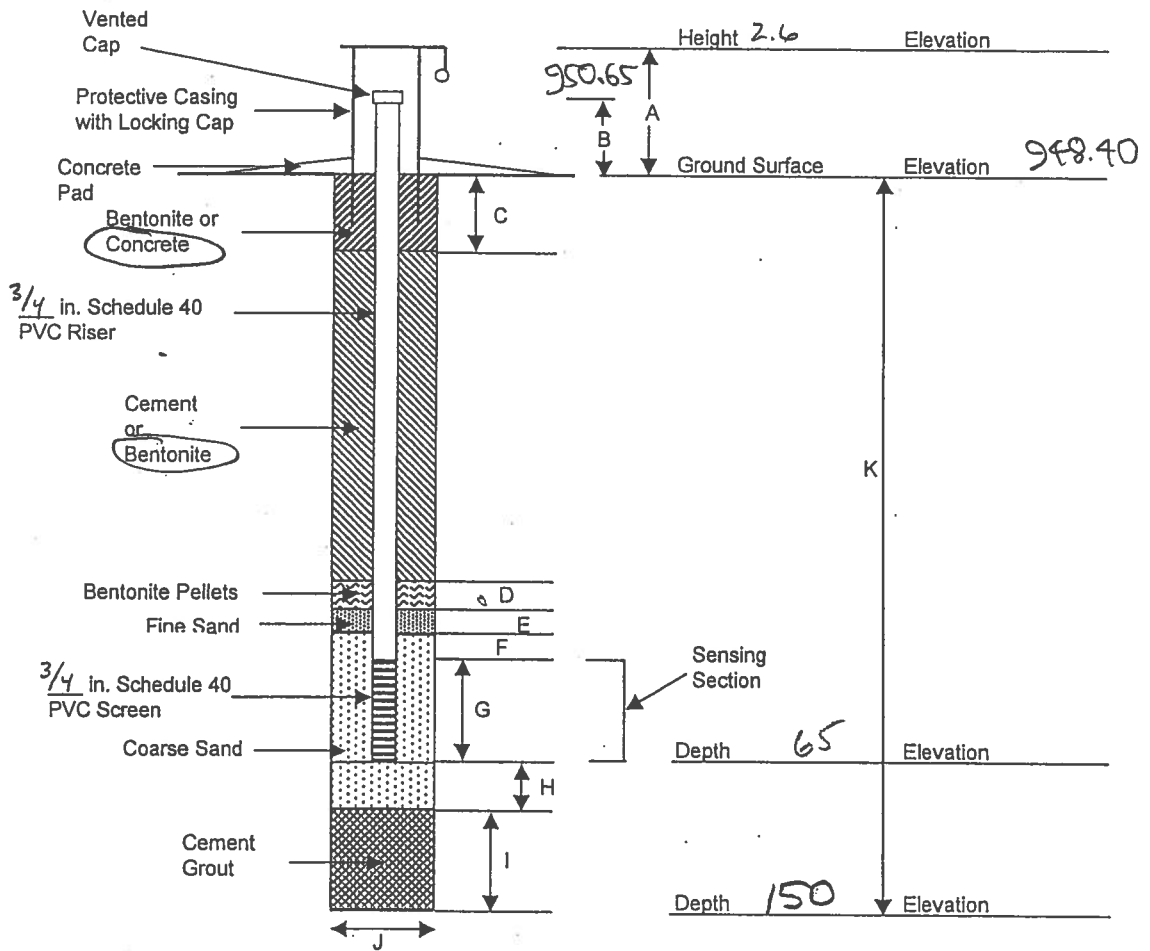

STANDPIPE PIEZOMETER INSTALLATION SKETCH

DIMENSIONS (Feet)					
A	B	C	D	E	F
2.6	2.25	17	—	—	38
G	H	I	J	K	
10	2	83	0.25	150	—

Remarks _____

MONITORING WELL CONSTRUCTION DIAGRAM
(Not to Scale)

Project AREA 2/3, JOHN E. AMOS POWER PLANT

Project No. 6040384.40-01

Date 16 MAY 2005

Engineer/Geologist DBS

Well No. B-0515

N 539572.1065
E 173680.1660

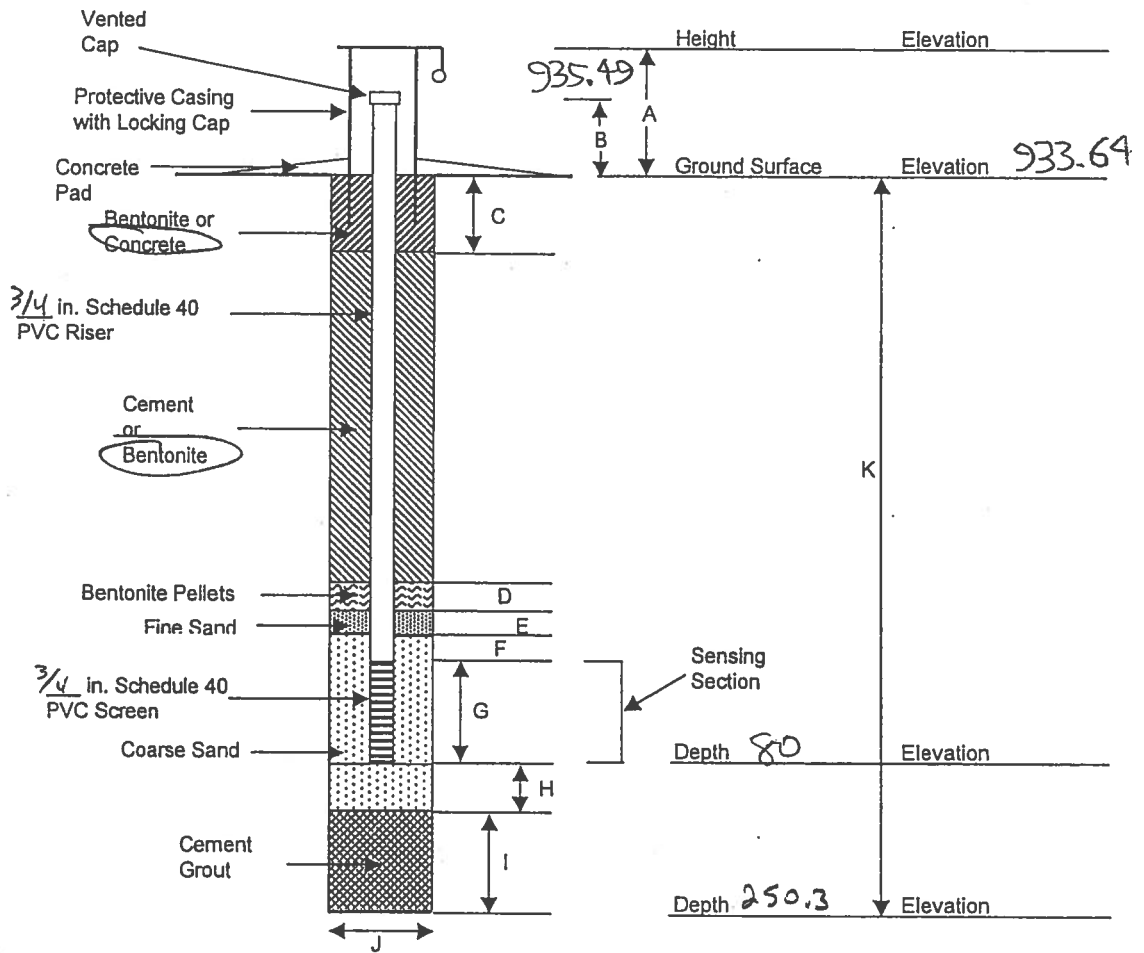

STANDPIPE PIEZOMETER INSTALLATION SKETCH

DIMENSIONS (Feet)					
A	B	C	D	E	F
2.1	1.85	20.0	—	—	50
G	H	I	J	K	
10	2	168.3	0.25	250.3	

Remarks _____

MONITORING WELL CONSTRUCTION DIAGRAM
(Not to Scale)

Project AREA 7/3 AMOS POWER PLANT

Project No. C040384.40-01

Date 19 MAR 2005

Engineer/Geologist DBS

Well No. B-0517

N 542185.2965
E 1725391.3276

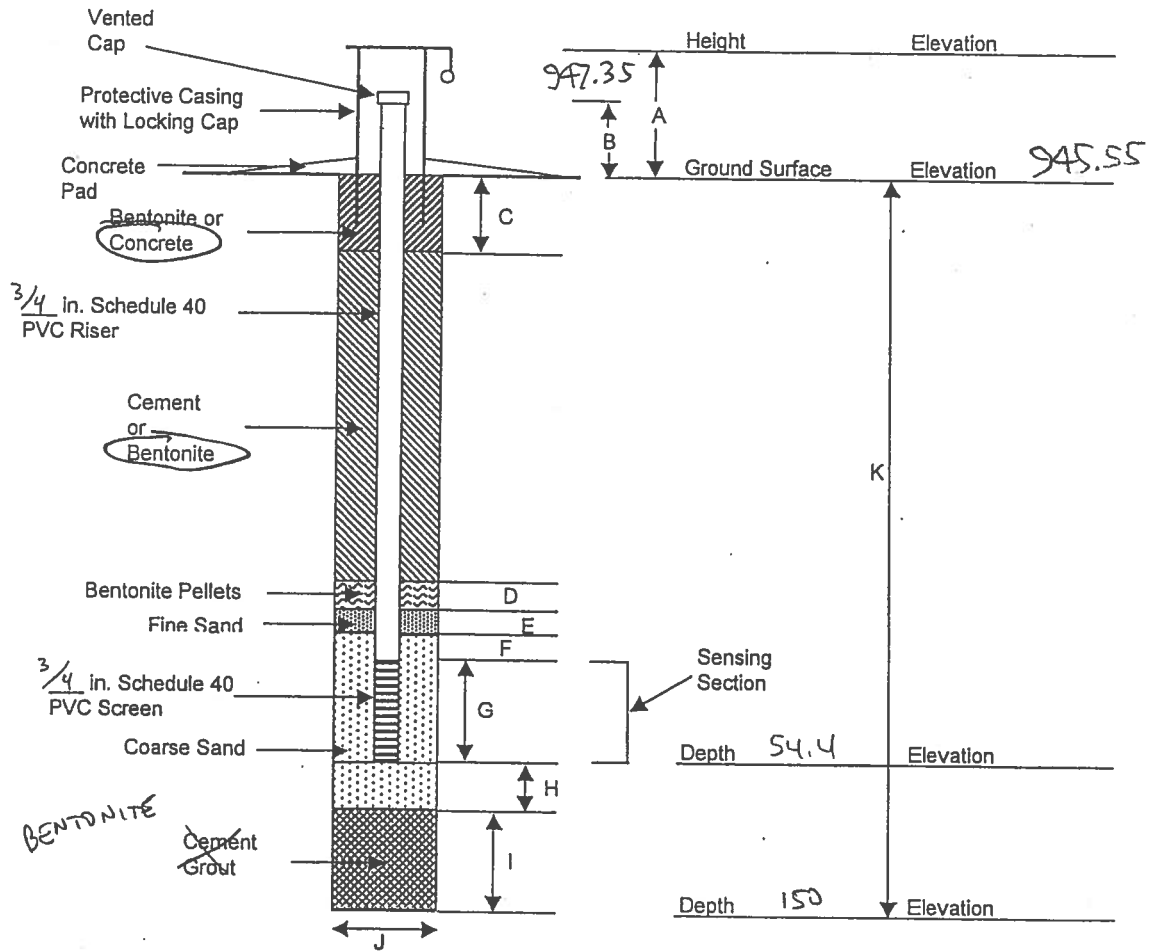

STANDPIPE PIEZOMETER INSTALLATION SKETCH

DIMENSIONS (Feet)					
A	B	C	D	E	F
2.3	1.8	14	—	—	30.4
G	H	I	J	K	
10	2	93.6	0.25	150	

Remarks PACKER ASSEMBLY STUCK IN HOLE. SALVAGED
UPPER PACKER AND PUMP. PUSHED REMAINDER DOWN HOLE.

MONITORING WELL CONSTRUCTION DIAGRAM
(Not to Scale)

Project REAR 3/4 COMP. AMAS PDR. S. F. RST

Project No. 0040384.43-01

Date 19 MAY 2005

Engineer/Geologist DBS

Well No. B-0517

N 543 732. 8856
E 1725136. 5233

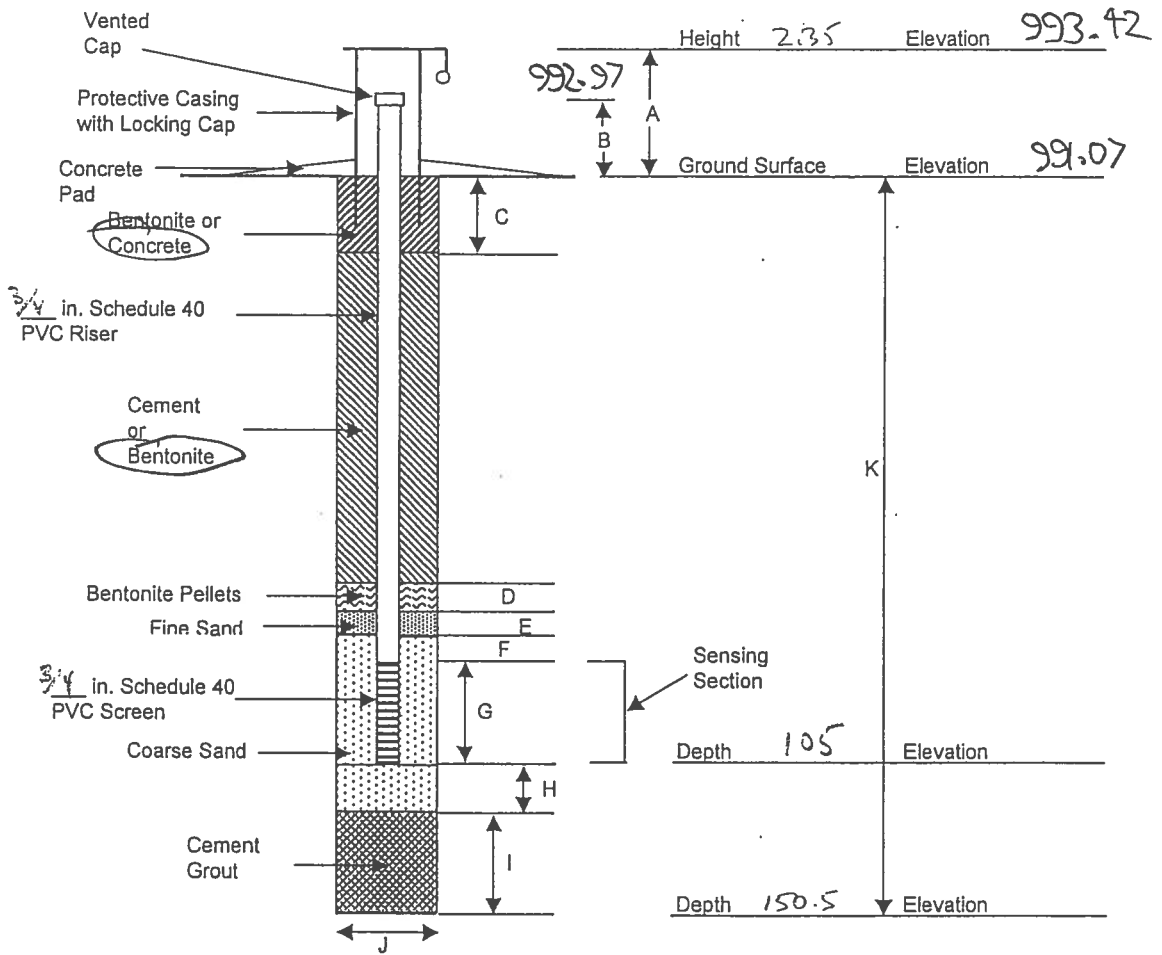

STANDPIPE PIEZOMETER INSTALLATION SKETCH

DIMENSIONS (Feet)					
A	B	C	D	E	F
2.35	1.4	15	—	—	80
G	H	I	J	K	
10	3	42.5	0.25	150.5	

Remarks _____

MONITORING WELL CONSTRUCTION DIAGRAM
(Not to Scale)

Project ARETA 2/3 AMOS POWER PLAN Project No. C0403.84.00-01
 Date 24 MAY 2005 Engineer/Geologist DBS Well No. B-0520
N 542378.3755
E 172739.7942

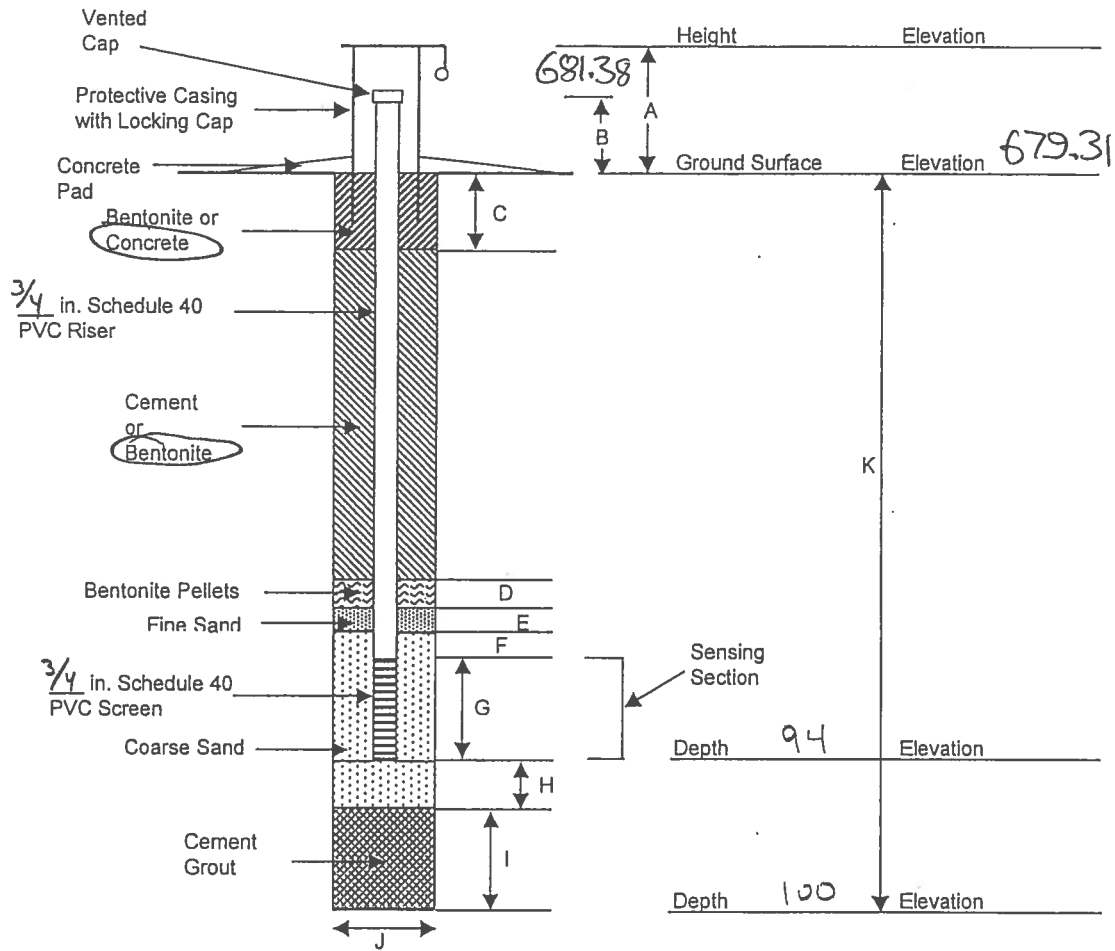

STANDPIPE PIEZOMETER INSTALLATION SKETCH

DIMENSIONS (Feet)					
A	B	C	D	E	F
2.4	2.07	34	—	—	50
G	H	I	J	K	
10	2	4	0.25	100	

Remarks _____

MONITORING WELL CONSTRUCTION DIAGRAM
(Not to Scale)

Project AREA #3, AMOS POWER PLANT Project No. C040384.40-01
Date 23 MAY 2005 Engineer/Geologist DBS Well No. B-0521

N 544199.5521
E 174094.5791

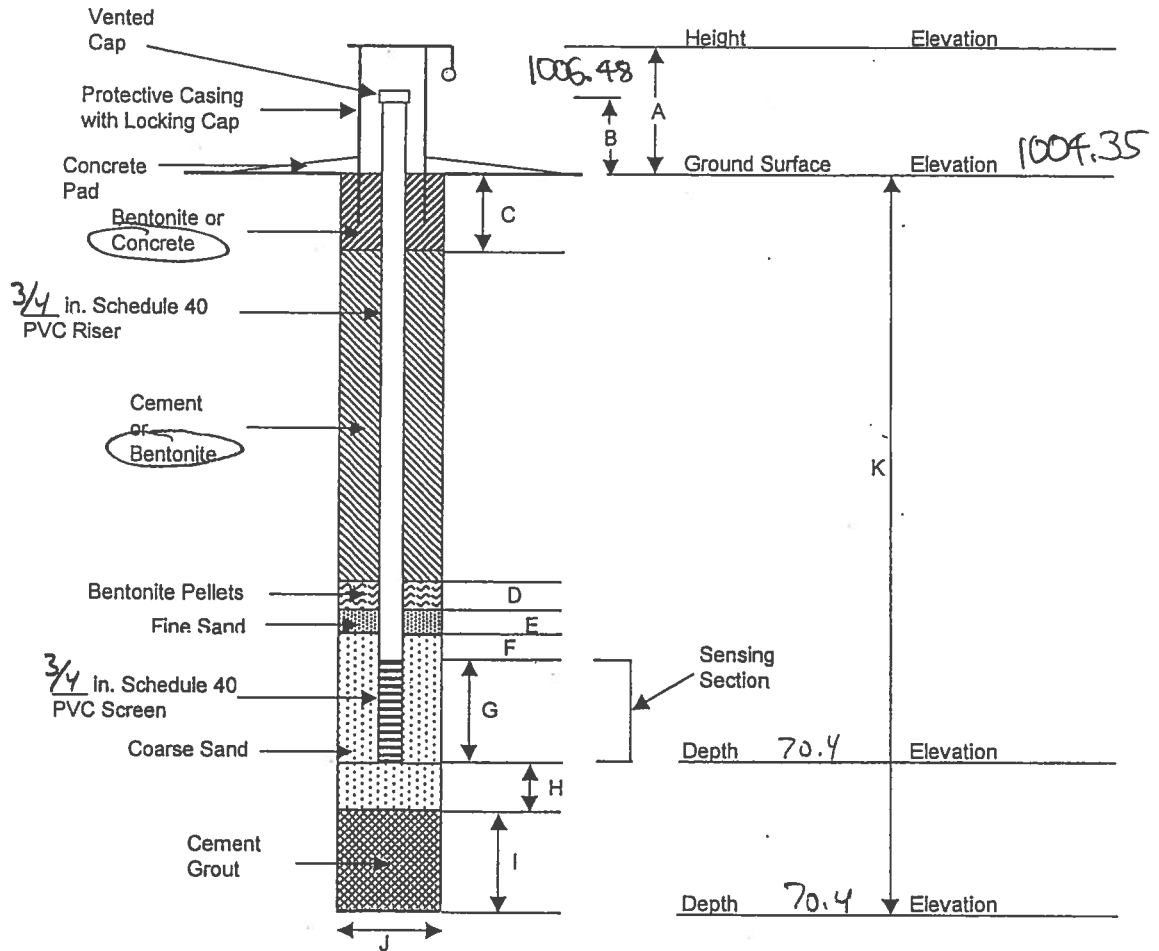

STANDPIPE PIEZOMETER INSTALLATION SKETCH

DIMENSIONS (Feet)					
A	B	C	D	E	F
2.58	2.13	12.4	—	—	48
G	H	I	J	K	
10	—	—	0.25	70.4	

Remarks _____

MONITORING WELL CONSTRUCTION DIAGRAM
(Not to Scale)

Project AREA 2/3 AMOS POWER PLANT

Project No. C040384.40-01

Date 25/26 MAY 2005

Engineer/Geologist DBS

Well No. B-0522

N 543873.4417
E 172326.4148

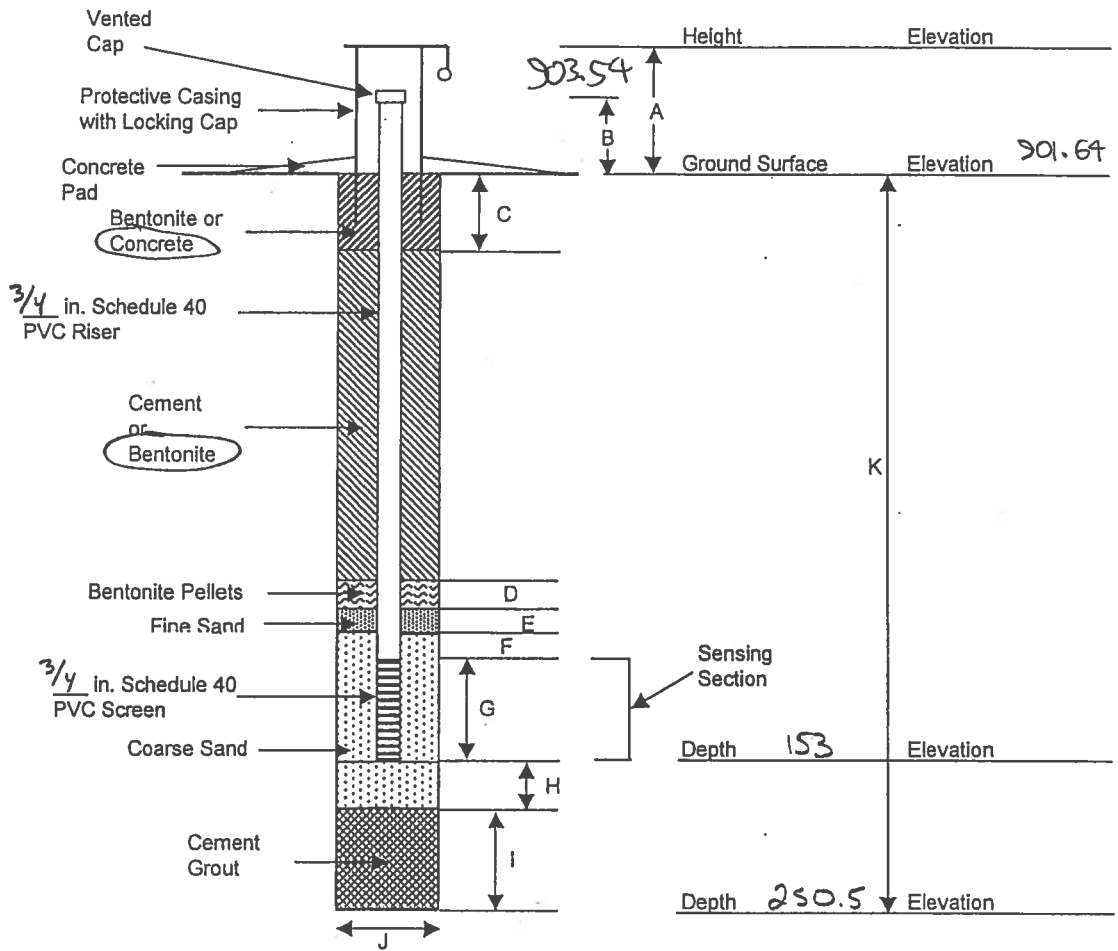

STANDPIPE PIEZOMETER INSTALLATION SKETCH

DIMENSIONS (Feet)					
A	B	C	D	E	F
2.18	1.9	35	←	←	98
G	H	I	J	K	
20	2	95.5	0.25	250.5	

Remarks _____

MONITORING WELL CONSTRUCTION DIAGRAM
(Not to Scale)

Project AREA 2/3 AMOS POWER PLANT Project No. C040384.40-01
Date 25 MAY 2005 Engineer/Geologist DPS Well No. B-0523

N 542742.2422
E 172248.6749

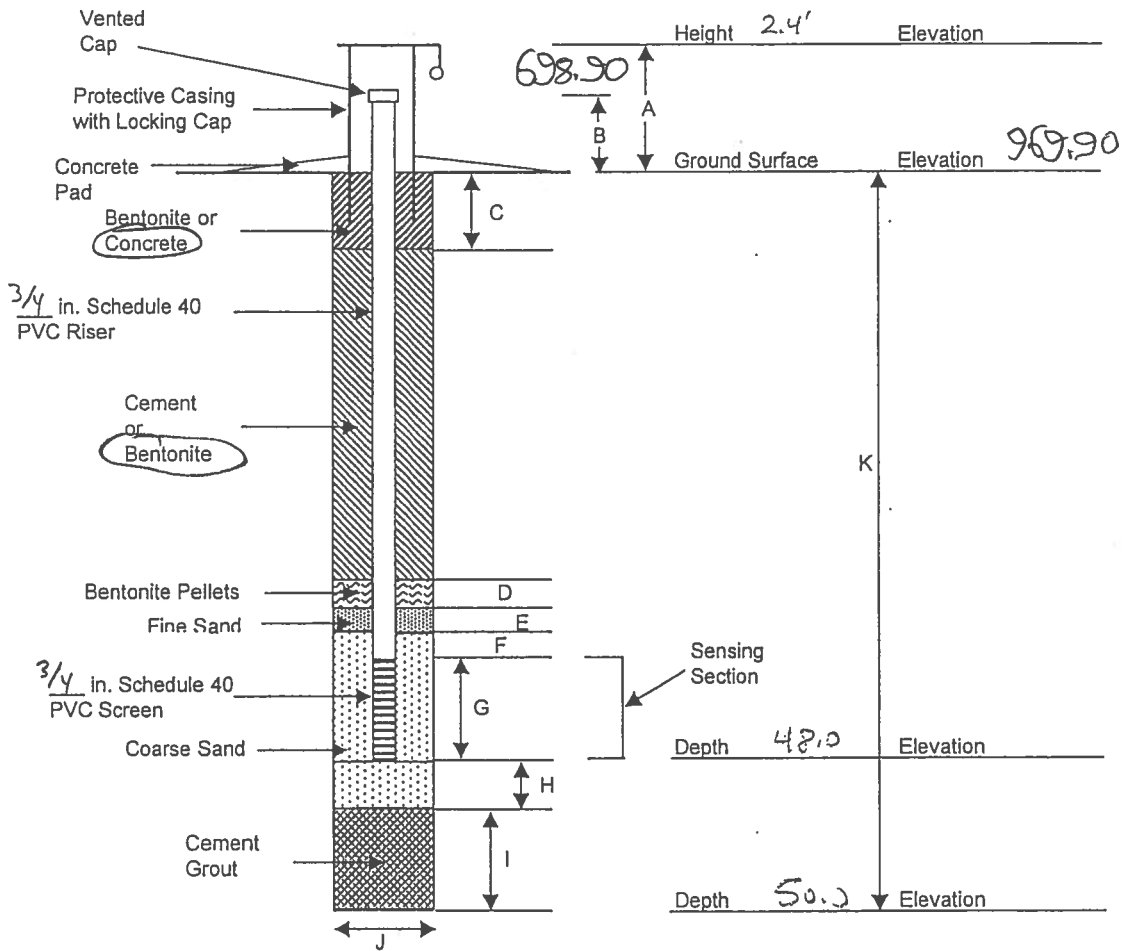

STANDPIPE PIEZOMETER INSTALLATION SKETCH

DIMENSIONS (Feet)					
A	B	C	D	E	F
2.4	2.0	24	-	-	14
G	H	I	J	K	
10	2	-	0.25	50.0	

Remarks _____

MONITORING WELL CONSTRUCTION DIAGRAM
(Not to Scale)

Project AREA 2/3, AMOS POWER PLANT Project No. C040324.40-01
 Date 25 MAY 2005 Engineer/Geologist D.B.S. Well No. B-0524
N 542745.0961
E 172251.4149

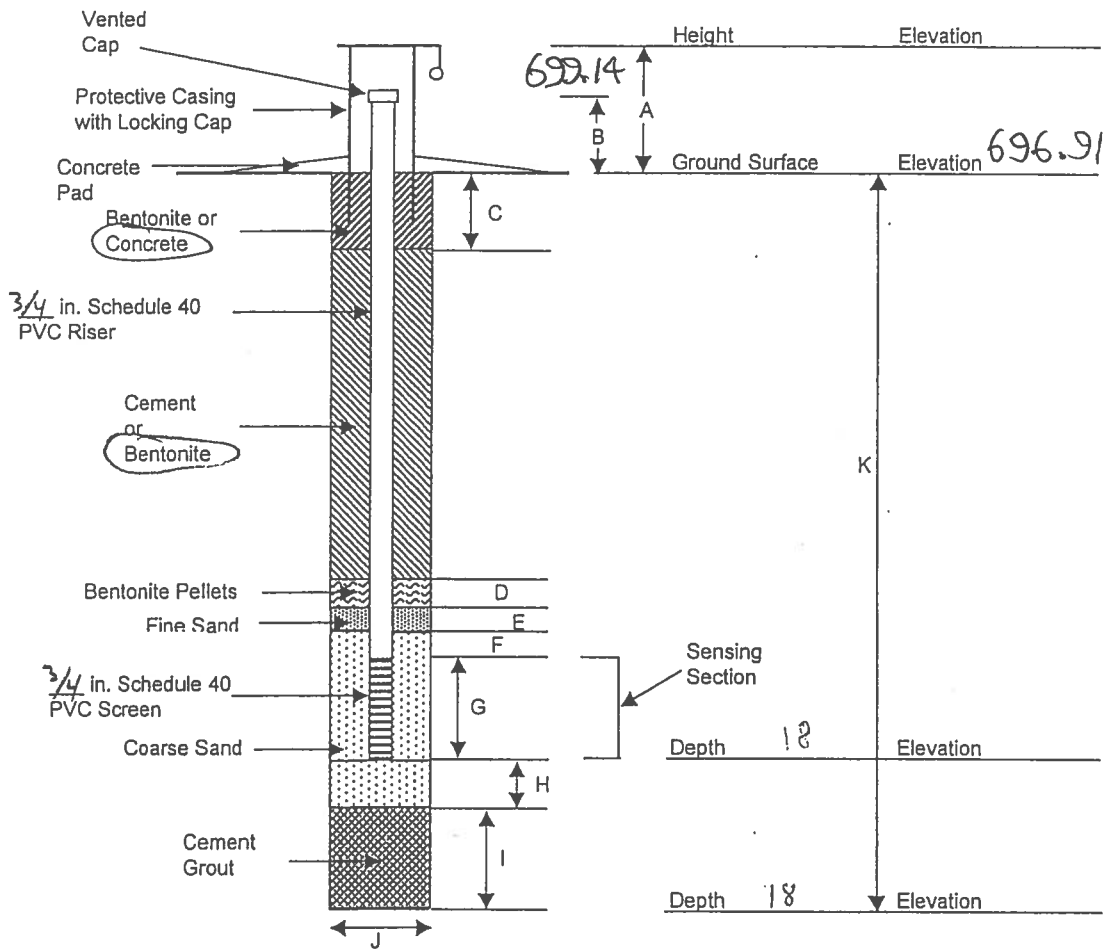

STANDPIPE PIEZOMETER INSTALLATION SKETCH

DIMENSIONS (Feet)					
A	B	C	D	E	F
2.55	2.23	3	-	-	5
G	H	I	J	K	
10	-	-	0.25	18	

Remarks _____

MONITORING WELL CONSTRUCTION DIAGRAM
(Not to Scale)

Project AREA 2/3 AMMS FORMAL PLANT

Project No. 6040384.120-01

Date 25 MAY 2025

Engineer/Geologist DBS

Well No. B-0525

N 542379.9472
E 1721745.3670

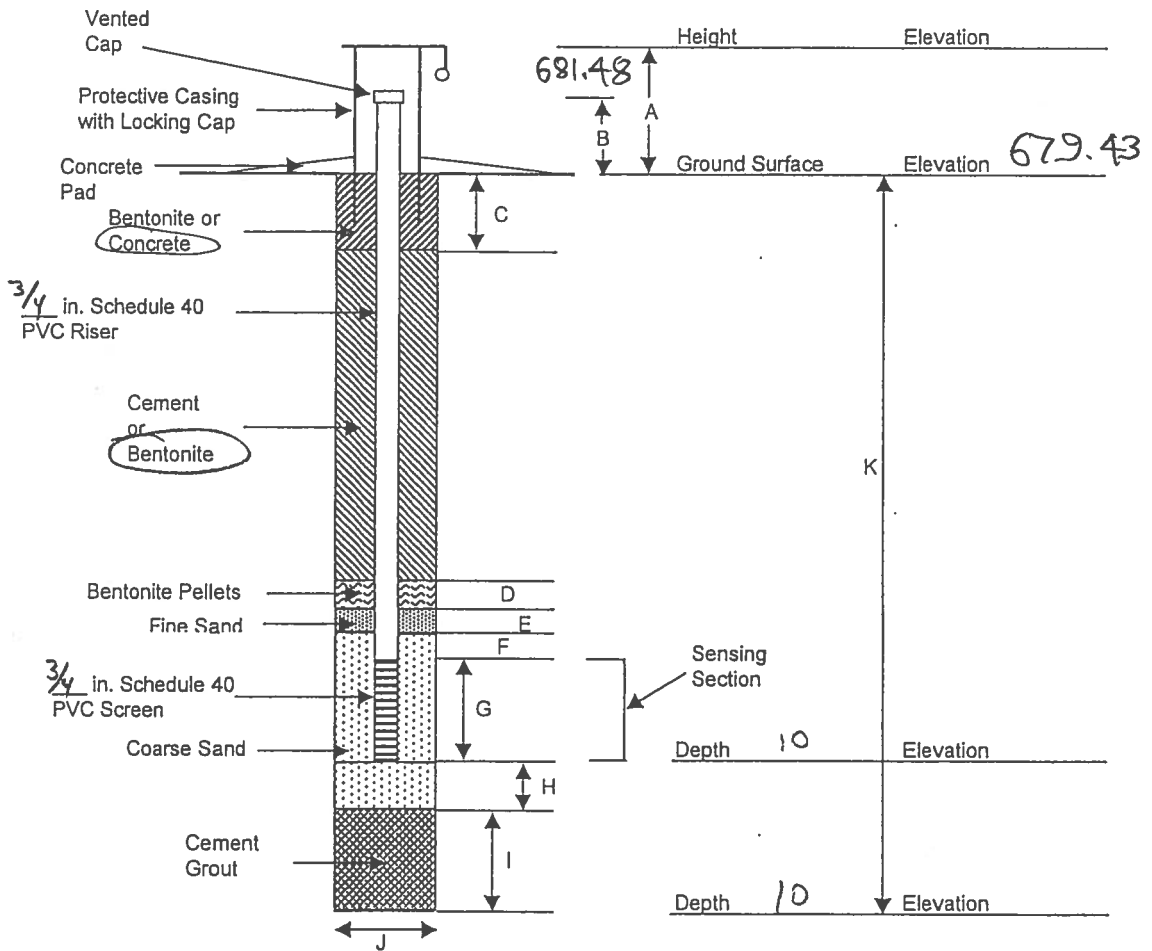

STANDPIPE PIEZOMETER INSTALLATION SKETCH

DIMENSIONS (Feet)					
A	B	C	D	E	F
2.3	2.05	2	-	-	3
G	H	I	J	K	
5	0	-	0.25	10	

Remarks _____

Well No: 05-36/MW-1

Project: John E. Amos Power Plant

Well Tag: 0275-24-05

TTI Proj. No: 05639

Date Installed: 07/12/05

Client: GAI Consultants, Inc.

GPS Location: Latitude: N 38° 28' 41.8"

Longitude: W 081° 51' 33.8"

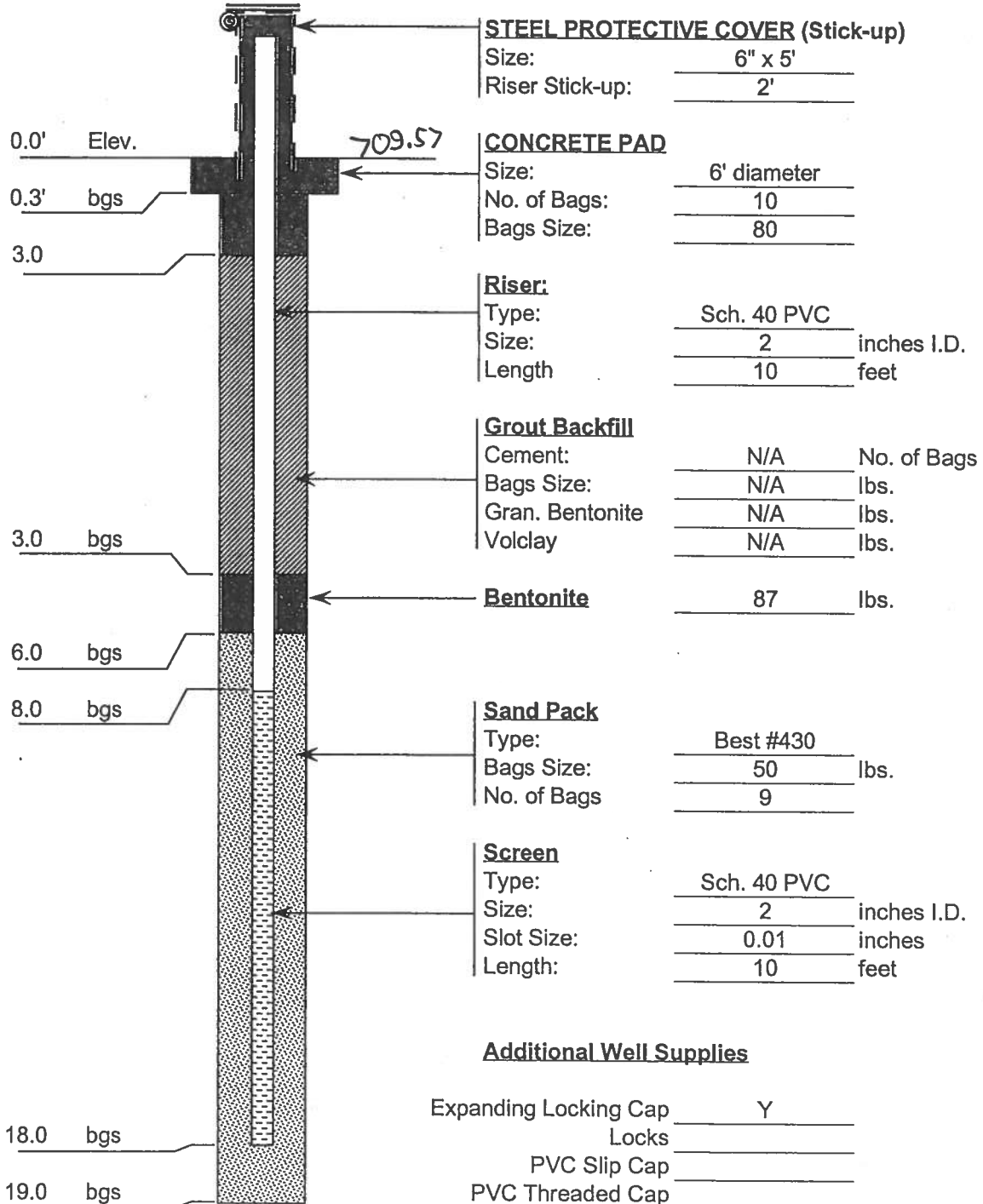

**State of West Virginia
Department of Environmental Protection**

Monitoring Well Construction
Well Number: WV00275-0024-05

Site Name/Physical Address:		Well Registration No. WV00275-0024-05	Purpose of Monitoring Well:
Site:	Proposed Landfill	Grid Location:	Monitor Groundwater
Line 1:	Area 2/3	a. Latitude:	38 28 41 ..8
Line 2:	Blue Lick Road	b. Longitude:	81 51 33 ..8
City:	Windfield	c. Method Used:	GPS
State:	WV		
Zip:	25213-	Company/Project Well No.:	
County:	Putnam	05839/05-36-MW-1	
Well Owner (Name, Firm, Address):		Installed By (Name, Firm, Address):	
Owner:	Tom Carroll	Installer:	Yern Curtis / Douglas Novotny
Line 1:	John E. Amos Power Plant	Line 1:	Terra Testing, Inc.
Line 2:	1530 Winfield Road	Line 2:	260 Meadowlands Boulevard
City:	Windfield	City:	Washington
State:	WV	State:	PA
Zip:	25213-	Zip:	15301-
Phone:	304-759-3156	Phone:	724-746-9100
		Date Well Installed:	07/12/2005
		Driller's WV Cert No.	WV00275

Section B: (all number fields must be in decimal format)

- 1.Cap and Lock: YES
- 2.Protective Cover: Protective Cover Pipe
- 3.Monitoring Well Reference Point: 0 ft.
- 4.Borehole Diameter: 4 inches.
- 5.Ground Surface Seal:
 - a.Material: concrete
 - b.Installation Procedure: Hand Mixed
- 6.Surface Seal Bottom/Annular Space Top: 3 ft.
- 7.Well Riser: a.OD Well Riser: 2.38 inches. b.ID Well Riser: 2 inches.
 - c.Material: PVC
 - d.Installation Procedure: Thru Augers & Open Bedrock Hole
- 8.Annular Space Seal:
 - a.Material: not applicable -
 - b.Installation Procedure: pour
- 9.Well Development Procedure: other - By Client
- 10.Drilling Method Used: percussion -
- 11.Annular Space Seal Bottom/Filter Seal Top: 3 ft.
- 12.Drilling Fluid Used: Yes Source: Air
- 13.Filter Pack Seal:
 - a.Material: bentonite pellet
 - b.Installation Procedure: Gravity Fed
 - c.Volume Added: 87 pounds
- 14.Bottom of Bentonite Seal/Filter Pack Top: 6 ft.
- 15.Depth to Top of Screen: 8 ft.
- 16.Screen:
 - a.Material: PVC
 - b.Installation Procedure: Thru Augers & Open Bedrock Hole
 - c.Slot Size: .01 inches. d.Screen Length: 10 ft.
- 17.Filter Pack:
 - a.Material: medium sand
 - b.Installation Procedure: Gravity Fed
- 18.Well Depth: 18 ft.
- 19.Bottom of Filter Pack: 19 ft.
- 20.Bottom of Borehole: 19 ft.
- 21.Backfill Material (below filter pack): Sand
- 22.Decontamination Procedures: None
- 23.Special Circumstances and Exceptions: Yes Variance Number: MW-07-05
- 24.WV Contractor License No. WV002350

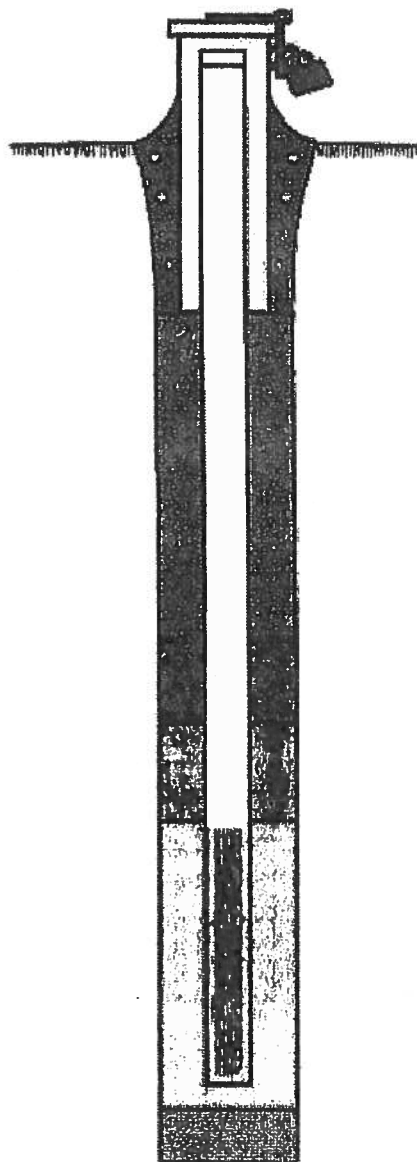

Well No: 05-35/MW-2

Project: John E. Amos Power Plant

Well Tag: 0275-25-05

TTI Proj. No: 05639

Date Installed: 07/12/05

Client: GAI Consultants, Inc.

GPS Location: Latitude: N 38° 28' 41.8"

Longitude: W 081° 51' 33.3"

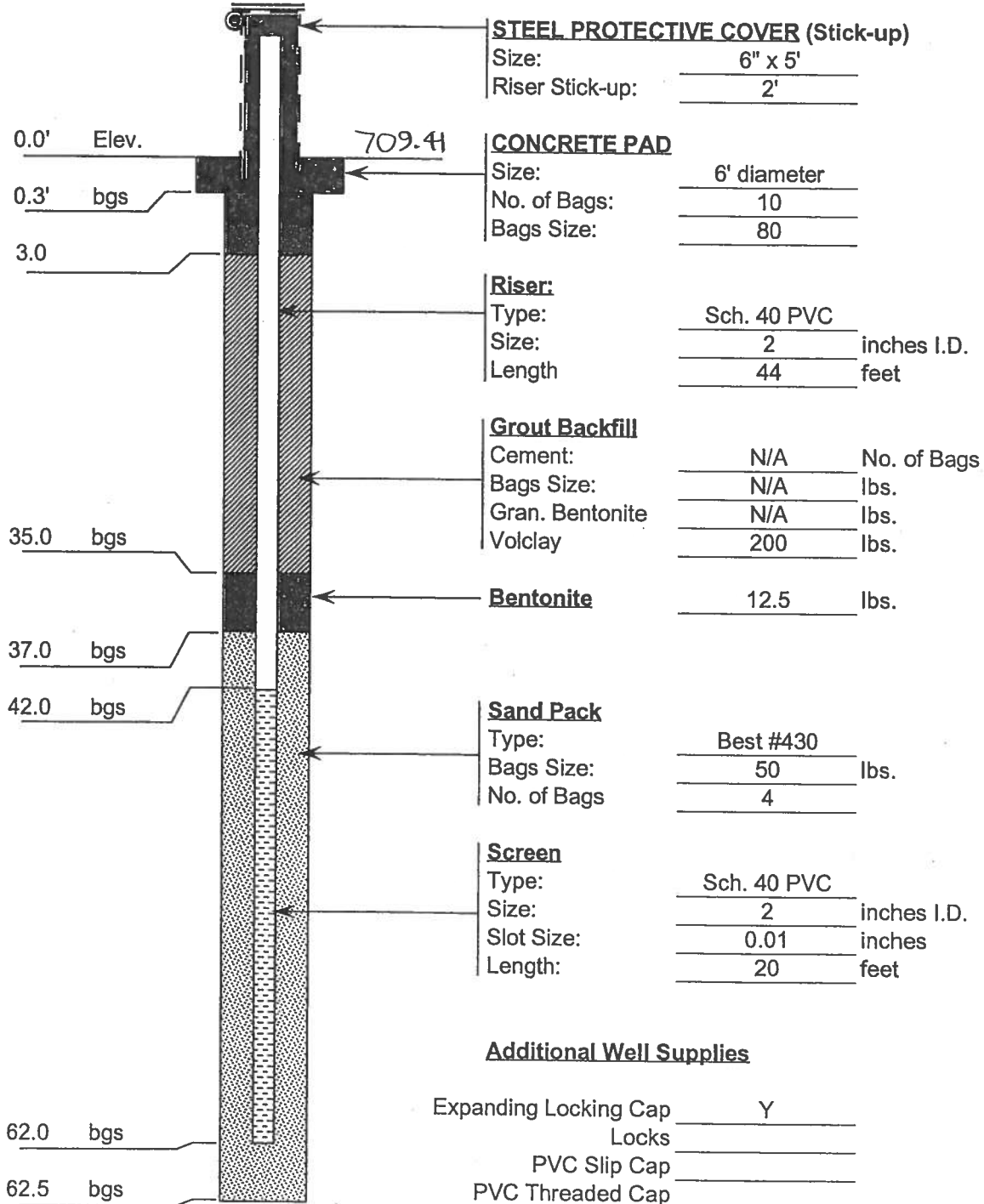

STEEL PROTECTIVE COVER (Stick-up)

Size: 6" x 5'
Riser Stick-up: 2'

CONCRETE PAD

Size: 6' diameter
No. of Bags: 10
Bags Size: 80

Riser:

Type: Sch. 40 PVC
Size: 2 inches I.D.
Length: 44 feet

Grout Backfill

Cement:	N/A	No. of Bags
Bags Size:	N/A	lbs.
Gran. Bentonite	N/A	lbs.
Volclay	200	lbs.

Bentonite

12.5 lbs.

Sand Pack

Type: Best #430
Bags Size: 50 lbs.
No. of Bags: 4

Screen

Type: Sch. 40 PVC
Size: 2 inches I.D.
Slot Size: 0.01 inches
Length: 20 feet

Additional Well Supplies

- Expanding Locking Cap Y
- Locks _____
- PVC Slip Cap _____
- PVC Threaded Cap _____
- PVC Bottom Plug Y
- Auger Plugs _____
- No. of 55-gallon Drums Used _____
- No of Guard Posts Used _____

**State of West Virginia
Department of Environmental Protection**

Monitoring Well Construction
Well Number: WV00275-0025-05

Site Name/Physical Address:		Well Registration No. WV00275-0025-05	Purpose of Monitoring Well:
Site: Proposed Landfill	Grid Location:	a. Latitude: 38 28 41 ..8	Monitor Groundwater
Line 1: Area 2/3	b. Longitude: 81 51 33 ..3	c. Method Used: GPS	
Line 2: Blue Lick Road			
City: Windfield			
State: WV			
Zip: 25213-	Company/Project Well No.:		
County: Putnam	05639/05-35-MW-2		
Well Owner (Name, Firm, Address):	Installed By (Name, Firm, Address):	Date Well Installed:	
Owner: Tom Carroll	Installer: Tom Curtis / Douglas Novotny	07/12/2005	
Line 1: John E. Amos Power Plant	Line 1: Terra Testing, Inc.	Driller's WV Cert No.	
Line 2: 1530 Winfield Road	Line 2: 260 Meadowlands Boulevard	WV00275	
City: Windfield	City: Washington		
State: WV	State: PA		
Zip: 25213-	Zip: 15301-		
Phone: 304-759-3156	Phone: 724-746-9100		

Section B: (all number fields must be in decimal format)

1. Cap and Lock:	YES
2. Protective Cover:	Protective Cover Pipe
3. Monitoring Well Reference Point:	0 ft.
4. Borehole Diameter:	4 inches.
5. Ground Surface Seal:	
a. Material: concrete	
b. Installation Procedure: Hand Mixed	
6. Surface Seal Bottom/Annular Space Top:	3 ft.
7. Well Riser: a. OD Well Riser: 2.38 inches. b. ID Well Riser: 2 inches.	
c. Material: PVC	
d. Installation Procedure: Thru Augers & Open Bedrock Hole	
8. Annular Space Seal:	
a. Material: high solids grout -	
b. Installation Procedure: pour	
9. Well Development Procedure: other - By Client	
10. Drilling Method Used: percussion -	
11. Annular Space Seal Bottom/Filter Seal Top:	35 ft.
12. Drilling Fluid Used: Yes Source: Air	
13. Filter Pack Seal:	
a. Material: bentonite pellet	
b. Installation Procedure: Gravity Fed	
c. Volume Added: 12.5 pounds	
14. Bottom of Bentonite Seal/Filter Pack Top:	37 ft.
15. Depth to Top of Screen:	42 ft.
16. Screen:	
a. Material: PVC	
b. Installation Procedure: Thru Augers & Open Bedrock Hole	
c. Slot Size: .01 inches. d. Screen Length: 20 ft.	
17. Filter Pack:	
a. Material: medium sand	
b. Installation Procedure: Gravy Fed	
18. Well Depth:	62 ft.
19. Bottom of Filter Pack:	62.5 ft.
20. Bottom of Borehole:	62.5 ft.
21. Backfill Material (below filter pack): sand	
22. Decontamination Procedures: None	
23. Special Circumstances and Exceptions: Yes Variance Number: MW-07-05	
24. WV Contractor License No. WV002350	

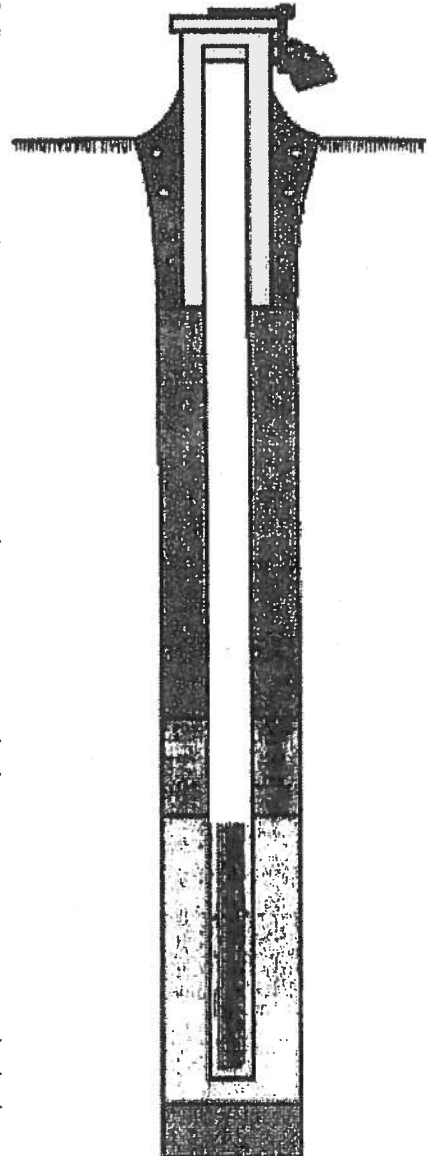

Well No: 05-27/MW-3

Project: John E. Amos Power Plant

Well Tag: 0275-26-05

TTI Proj. No: 05639

Date Installed: 06/27/05

Client: GAI Consultants, Inc.

GPS Location: Latitude: N 38° 29' 04.4"

Longitude: W 081° 51' 13.5"

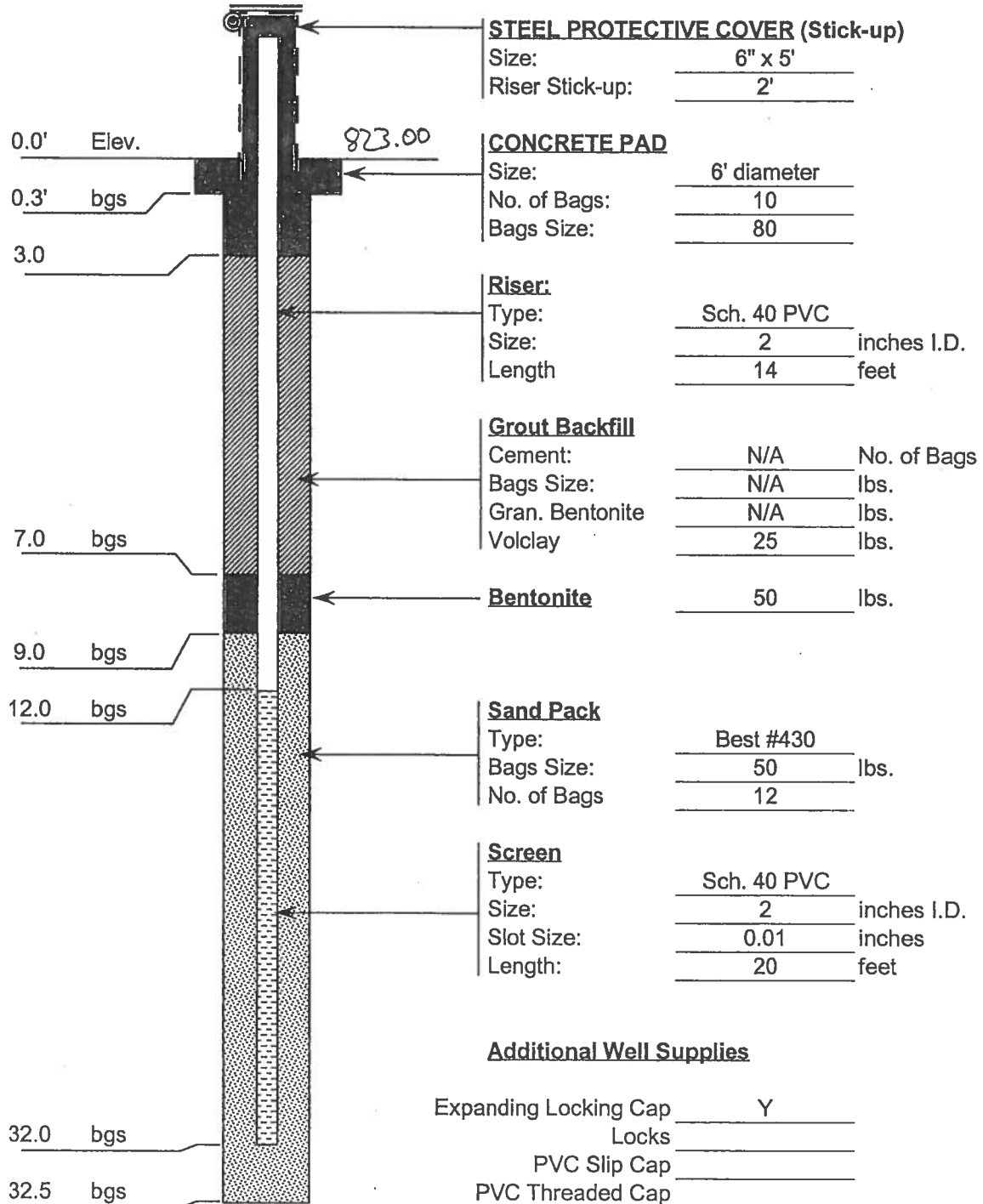

Additional Well Supplies

Expanding Locking Cap	Y
Locks	
PVC Slip Cap	
PVC Threaded Cap	
PVC Bottom Plug	Y
Auger Plugs	
No. of 55-gallon Drums Used	
No of Guard Posts Used	

**State of West Virginia
Department of Environmental Protection**

Monitoring Well Construction
Well Number: WV00275-0026-05

Site Name/Physical Address: Site: Proposed Landfill Line 1: Area 2/3 Line 2: Blue Lick Road City: Windfield State: WV Zip: 25213- County: Putnam	Well Registration No. WV00275-0026-05 Grid Location: a. Latitude: 38 29 4 .4 b. Longitude: 81 51 13 .5 c. Method Used: GPS	Purpose of Monitoring Well: Monitor Groundwater
Well Owner (Name, Firm, Address): Owner: Tom Carroll Line 1: John E. Amos Power Plant Line 2: 1530 Winfield Road City: Windfield State: WV Zip: 25213- Phone: 304-759-3156	Company/Project Well No.: 05639/05-27-MW-3 Installed By (Name, Firm, Address): Installer: Tom Curtis / Douglas Novotny Line 1: Terra Testing, Inc. Line 2: 260 Meadowlands Boulevard City: Washington State: PA Zip: 15301- Phone: 724-746-9100	Date Well Installed: 06/27/2005 Driller's WV Cert No. WV00275

Section B: (all number fields must be in decimal format)

- 1. Cap and Lock: YES
- 2. Protective Cover: Protective Cover Pipe
- 3. Monitoring Well Reference Point: 0 ft.
- 4. Borehole Diameter: 4 inches.
- 5. Ground Surface Seal:
 - a. Material: concrete
 - b. Installation Procedure: Hand Mixed
- 6. Surface Seal Bottom/Annular Space Top: 3 ft.
- 7. Well Riser: a. OD Well Riser: 2.38 inches. b. ID Well Riser: 2 inches.
 - c. Material: PVC
 - d. Installation Procedure: Thru Augers & Open Bedrock Hole
- 8. Annular Space Seal:
 - a. Material: high solids grout -
 - b. Installation Procedure: pour
- 9. Well Development Procedure: other - By Client
- 10. Drilling Method Used: percussion -
- 11. Annular Space Seal Bottom/Filter Seal Top: 7 ft.
- 12. Drilling Fluid Used: Yes Source: Air
- 13. Filter Pack Seal:
 - a. Material: bentonite pellet
 - b. Installation Procedure: Gravity Fed
 - c. Volume Added: 50 pounds
- 14. Bottom of Bentonite Seal/Filter Pack Top: 9 ft.
- 15. Depth to Top of Screen: 12 ft.
- 16. Screen:
 - a. Material: PVC
 - b. Installation Procedure: Thru Augers & Open Bedrock Hole
 - c. Slot Size: .01 inches. d. Screen Length: 20 ft.
- 17. Filter Pack:
 - a. Material: medium sand
 - b. Installation Procedure: Gravity fed
- 18. Well Depth: 32 ft.
- 19. Bottom of Filter Pack: 32.5 ft.
- 20. Bottom of Borehole: 32.5 ft.
- 21. Backfill Material (below filter pack): sand
- 22. Decontamination Procedures: None
- 23. Special Circumstances and Exceptions: Yes Variance Number: MW-07-05
- 24. WV Contractor License No. WV002350

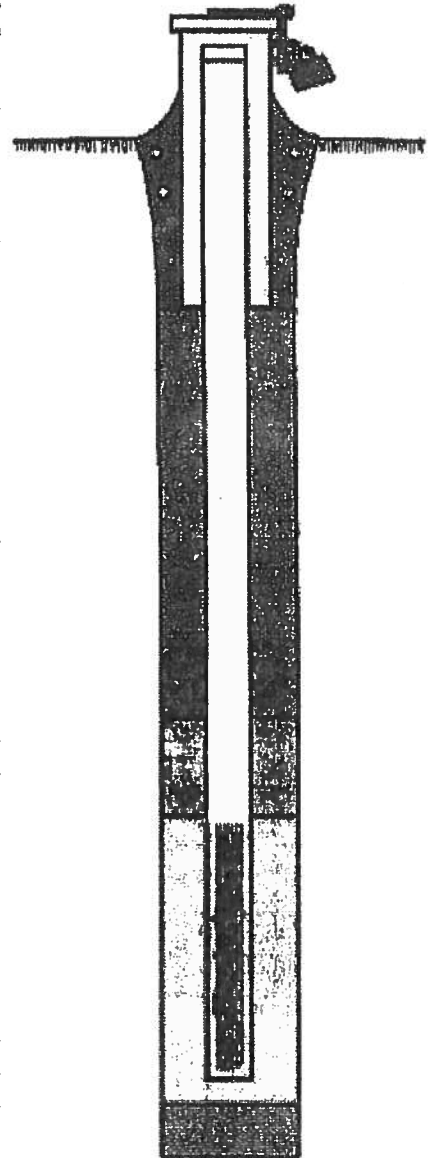

Well No: 05-32/MW-4

Project: John E. Amos Power Plant

Well Tag: 0275-27-05

TTI Proj. No: 05639

Date Installed: 07/07/05

Client: GAI Consultants, Inc.

GPS Location: Latitude: N 38° 29' 10.03"

Longitude: W 081° 51' 45.0"

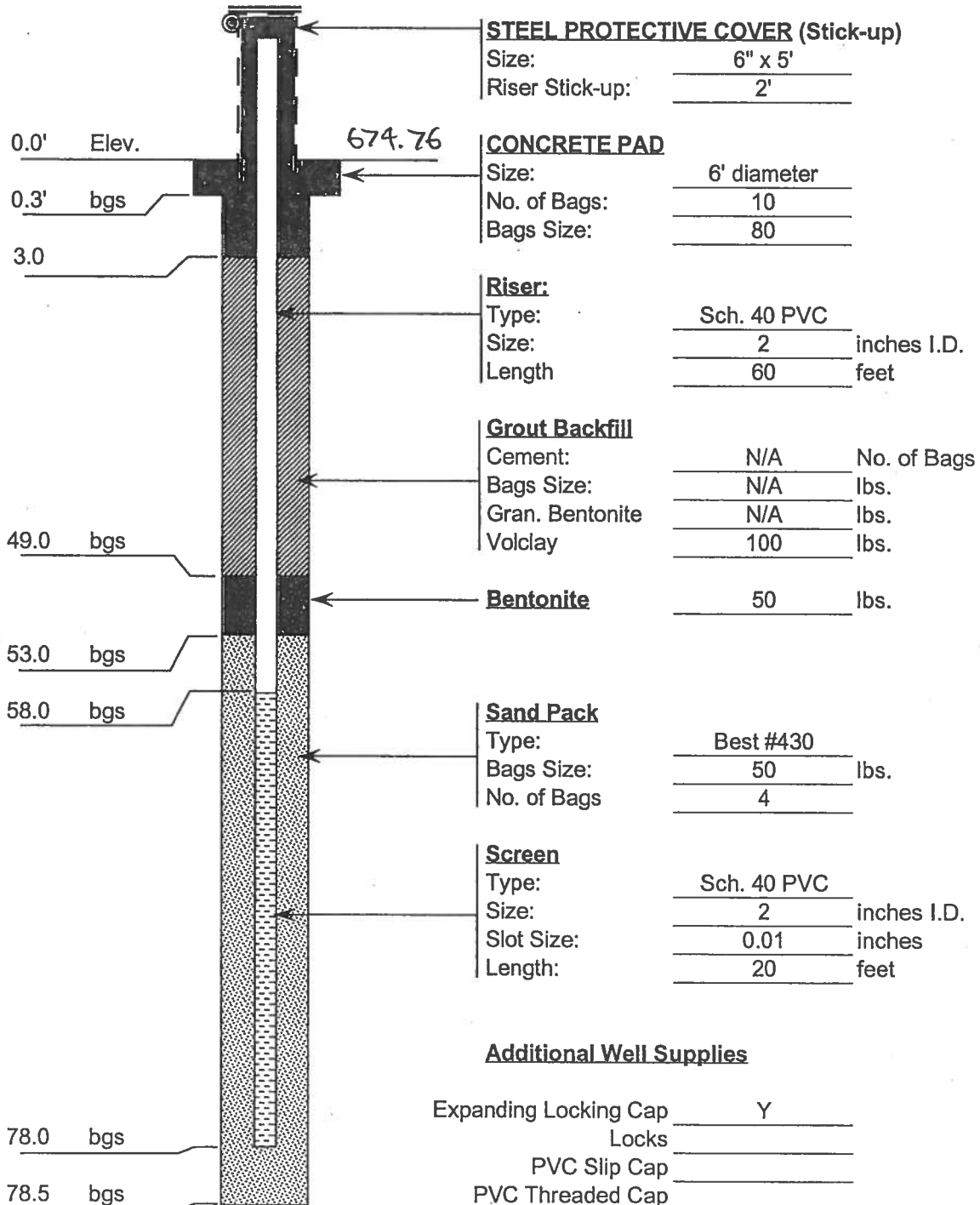

Additional Well Supplies

Expanding Locking Cap	Y
Locks	
PVC Slip Cap	
PVC Threaded Cap	
PVC Bottom Plug	Y
Auger Plugs	
No. of 55-gallon Drums Used	
No of Guard Posts Used	

**State of West Virginia
Department of Environmental Protection**

Monitoring Well Construction
Well Number: WV00275-0027-05

Site Name/Physical Address: Site: Proposed Landfill Line 1: Area 2/3 Line 2: Blue Lick Road City: Windfield State: WV Zip: 25213- County: Putnam	Well Registration No. WV00275-0027-05 Grid Location: a. Latitude: 38 29 10 .03 b. Longitude: 81 51 45 . c. Method Used: GPS	Purpose of Monitoring Well: Monitor Groundwater
Well Owner (Name, Firm, Address): Owner: Tom Carroll Line 1: John E. Amos Power Plant Line 2: 1530 Winfield Road City: Windfield State: WV Zip: 25213- Phone: 304-759-3156	Company/Project Well No.: 05639/05-32-MW-4 Installed By (Name, Firm, Address): Installer: Tom Curtis / Douglas Novotny Line 1: Terra Testing, Inc. Line 2: 260 Meadowlands Boulevard City: Washington State: PA Zip: 15301- Phone: 724-746-9100	Date Well Installed: 07/07/2005 Driller's WV Cert No. WV00275

Section B: (all number fields must be in decimal format)

1.Cap and Lock:	YES
2.Protective Cover:	Protective Cover Pipe
3.Monitoring Well Reference Point:	0 ft.
4.Borehole Diameter:	4 inches.
5.Ground Surface Seal: a.Material: concrete b.Installation Procedure: Hand Mixed	
6.Surface Seal Bottom/Annular Space Top:	3 ft.
7.Well Riser: a.OD Well Riser: 2.38 inches. b.ID Well Riser: 2 inches. c.Material: PVC d.Installation Procedure: Thru Augers & Open Bedrock Hole	
8.Annular Space Seal: a.Material: high solids grout - b.Installation Procedure: pour	
9.Well Development Procedure: other - By Client	
10.Drilling Method Used: percussion -	
11.Annular Space Seal Bottom/Filter Seal Top:	49 ft.
12.Drilling Fluid Used: Yes Source: Air	
13.Filter Pack Seal: a.Material: bentonite pellet b.Installation Procedure: Gravity Fed c.Volume Added: 50 pounds	
14.Bottom of Bentonite Seal/Filter Pack Top:	53 ft.
15.Depth to Top of Screen:	58 ft.
16.Screen: a.Material: PVC b.Installation Procedure: Thru Augers & Open Bedrock Hole c.Slot Size: .01 inches. d.Screen Length: 20 ft.	
17.Filter Pack: a.Material: medium sand b.Installation Procedure: Gravity Fed	
18.Well Depth:	78 ft.
19.Bottom of Filter Pack:	78.5 ft.
20.Bottom of Borehole:	78.5 ft.
21.Backfill Material (below filter pack): sand	
22.Decontamination Procedures: None	
23.Special Circumstances and Exceptions: Yes Variance Number: MW-07-05	
24.WV Contractor License No. WV002350	



Well No: 05-33/MW-5

Project: John E. Amos Power Plant

Well Tag: 0275-28-05

TTI Proj. No: 05639

Date Installed: 07/07/05

Client: GAI Consultants, Inc.

GPS Location: Latitude: N 38° 29' 10.00"

Longitude: W 081° 51' 44.6"

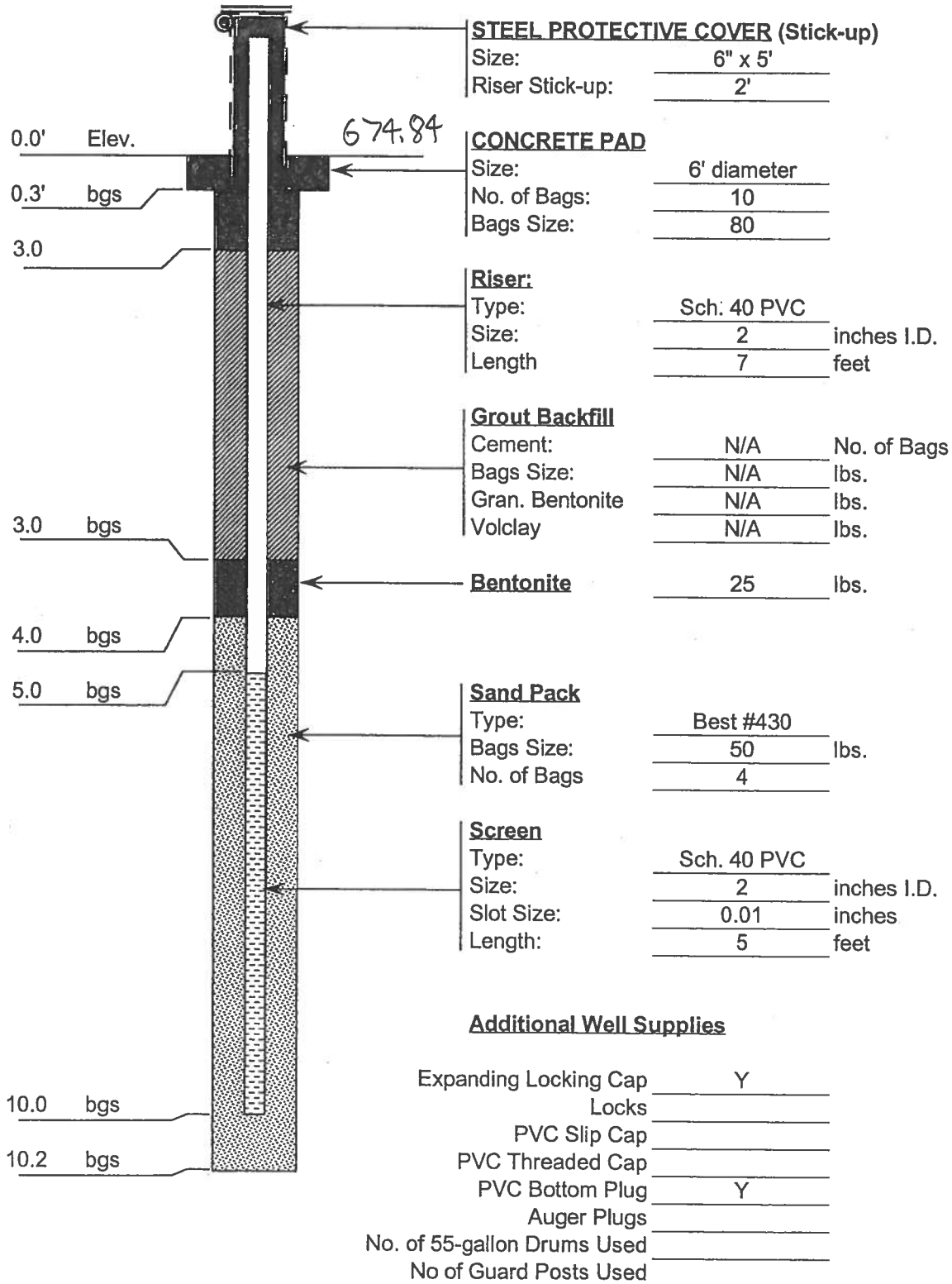

**State of West Virginia
Department of Environmental Protection**

Monitoring Well Construction
Well Number: WV00275-0028-05

Site Name/Physical Address: Site: Proposed Landfill Line 1: Area 2/3 Line 2: Blue Lick Road City: Windfield State: WV Zip: 25213- County: Putnam	Well Registration No. WV00275-0028-05 Grid Location: a. Latitude: 38 29 10 . b. Longitude: 81 51 44 .6 c. Method Used: GPS	Purpose of Monitoring Well: Monitor Groundwater
Well Owner (Name, Firm, Address): Owner: Tom Carroll Line 1: John E. Amos Power Plant Line 2: 1530 Winfield Road City: Windfield State: WV Zip: 25213- Phone: 304-759-3156	Company/Project Well No.: 05639/05-33-MW-5 Installed By (Name, Firm, Address): Installer: Vern Curtis / Douglas Novotny Line 1: Terra Testing, Inc. Line 2: 260 Meadowlands Boulevard City: Washington State: PA Zip: 15301- Phone: 724-746-9100	Date Well Installed: 07/07/2005 Driller's WV Cert No. WV00275

Section B: (all number fields must be in decimal format)

- 1.Cap and Lock: YES
- 2.Protective Cover: Protective Cover Pipe
- 3.Monitoring Well Reference Point: 0 ft.
- 4.Borehole Diameter: 4 inches.
- 5.Ground Surface Seal:
a.Material: concrete
b.Installation Procedure: Hand Mixed
- 6.Surface Seal Bottom/Annular Space Top: 3 ft.
- 7.Well Riser: a.OD Well Riser: 2.38 inches. b.ID Well Riser: 2 inches.
c.Material: PVC
d.Installation Procedure: Thru Augers & Open Bedrock Hole
- 8.Annular Space Seal:
a.Material: high solids grout -
b.Installation Procedure: pour
- 9.Well Development Procedure: other - By Client
- 10.Drilling Method Used: percussion -
- 11.Annular Space Seal Bottom/Filter Seal Top: 3 ft.
- 12.Drilling Fluid Used: Yes Source: Air
- 13.Filter Pack Seal:
a.Material: bentonite pellet
b.Installation Procedure: Gravity Fed
c.Volume Added: 25 pounds
- 14.Bottom of Bentonite Seal/Filter Pack Top: 4 ft.
- 15.Depth to Top of Screen: 5 ft.
- 16.Screen:
a.Material: PVC
b.Installation Procedure: Thru Augers & Open Bedrock Hole
c.Slot Size: .01 inches. d.Screen Length: 5 ft.
- 17.Filter Pack:
a.Material: medium sand
b.Installation Procedure: Gravity Fed
- 18.Well Depth: 10 ft.
- 19.Bottom of Filter Pack: 10.2 ft.
- 20.Bottom of Borehole: 10.2 ft.
- 21.Backfill Material (below filter pack): sand
- 22.Decontamination Procedures: None
- 23.Special Circumstances and Exceptions: Yes Variance Number: MW-07-05
- 24.WV Contractor License No. WV002350

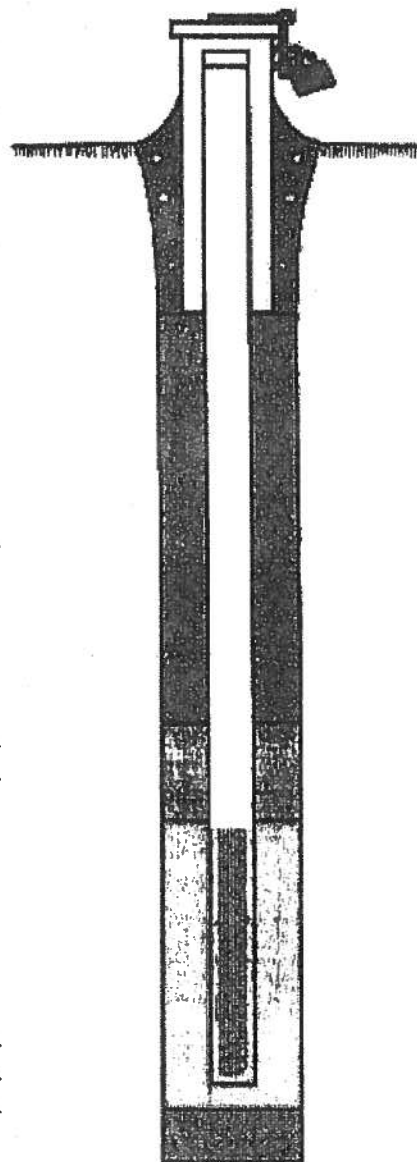

Well No: 05-26/MW-6

Project: John E. Amos Power Plant

Well Tag: 0275-29-05

TTI Proj. No: 05639

Date Installed: 06/23/05

Client: GAI Consultants, Inc.

GPS Location: Latitude: N 38° 28' 56.1"

Longitude: W 081° 51' 30.6"

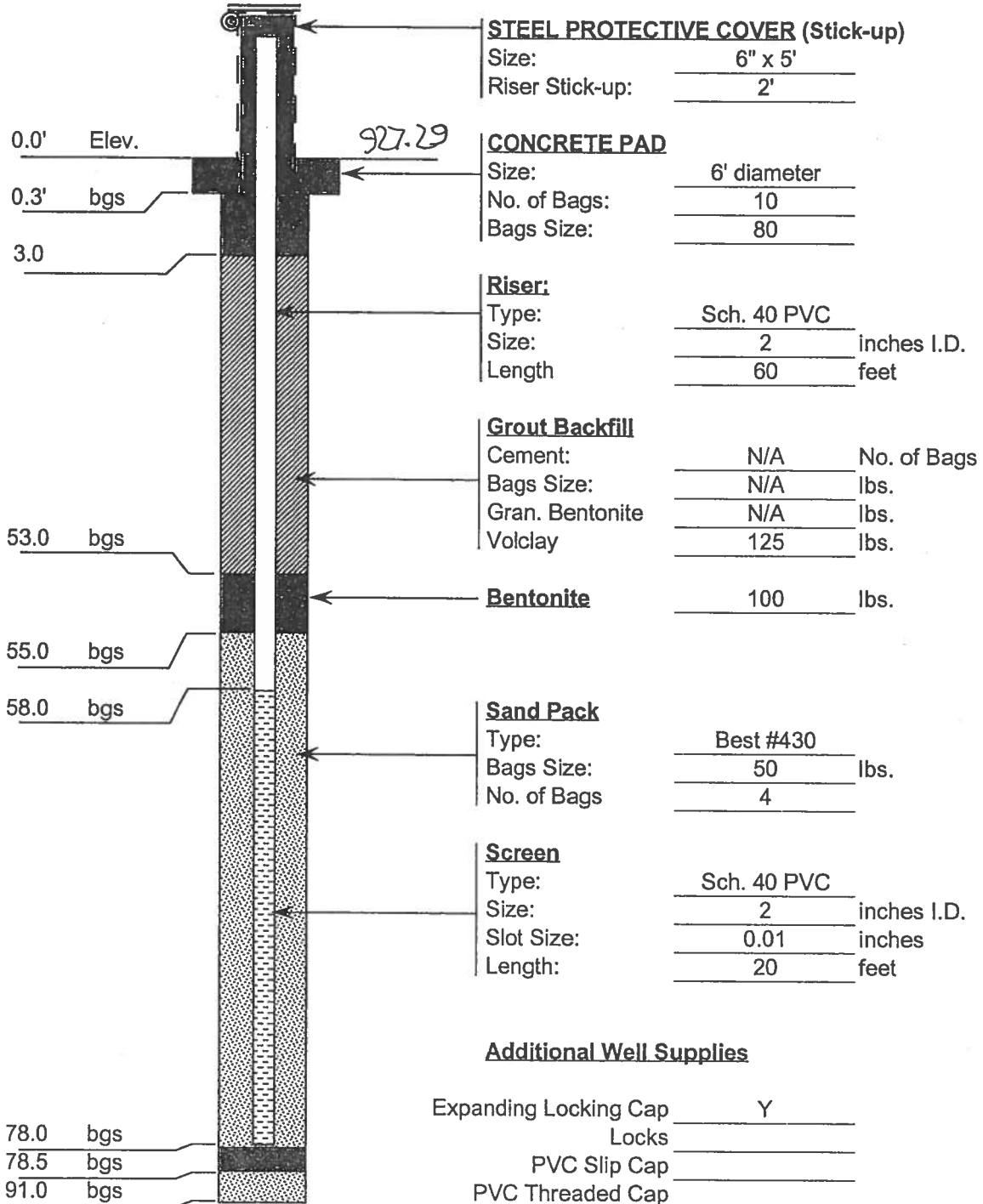

STEEL PROTECTIVE COVER (Stick-up)

Size: 6" x 5'
Riser Stick-up: 2'

CONCRETE PAD

Size: 6' diameter
No. of Bags: 10
Bags Size: 80

Riser:

Type: Sch. 40 PVC
Size: 2 inches I.D.
Length: 60 feet

Grout Backfill

Cement: N/A No. of Bags
Bags Size: N/A lbs.
Gran. Bentonite: N/A lbs.
Volclay: 125 lbs.

Bentonite

100 lbs.

Sand Pack

Type: Best #430
Bags Size: 50 lbs.
No. of Bags: 4

Screen

Type: Sch. 40 PVC
Size: 2 inches I.D.
Slot Size: 0.01 inches
Length: 20 feet

Additional Well Supplies

Expanding Locking Cap Y
Locks _____
PVC Slip Cap _____
PVC Threaded Cap _____
PVC Bottom Plug Y
Auger Plugs _____
No. of 55-gallon Drums Used _____
No of Guard Posts Used _____

PELLETS

78.0 bgs
78.5 bgs
91.0 bgs

**State of West Virginia
Department of Environmental Protection**

**Monitoring Well Construction
Well Number: WV00275-0029-05**

Site Name/Physical Address: Site: Proposed Landfill Line 1: Area 2/3 Line 2: Blue Lick Road City: Windfield State: WV Zip: 25213- County: Putnam	Well Registration No. WV00275-0029-05 Grid Location: a. Latitude: 38 28 56 .1 b. Longitude: 81 51 30 .6 c. Method Used: GPS	Purpose of Monitoring Well: Monitor Groundwater
Well Owner (Name, Firm, Address): Owner: Tom Carroll Line 1: John E. Amos Power Plant Line 2: 1530 Winfield Road City: Windfield State: WV Zip: 25213- Phone: 304-759-3156	Company/Project Well No.: 05639/05-26-MW-6 Installed By (Name, Firm, Address): Installer: Vern Curtis / Douglas Novotny Line 1: Terra Testing, Inc. Line 2: 280 Meadowlands Boulevard City: Washington State: PA Zip: 15301- Phone: 724-746-9100	Date Well Installed: 06/23/2005 Driller's WV Cert No. WV00275

Section B: (all number fields must be in decimal format)

- 1. Cap and Lock: YES
- 2. Protective Cover: Protective Cover Pipe
- 3. Monitoring Well Reference Point: 0 ft.
- 4. Borehole Diameter: 4 inches.
- 5. Ground Surface Seal:
a. Material: concrete
b. Installation Procedure: Hand Mixed
- 6. Surface Seal Bottom/Annular Space Top: 3 ft.
- 7. Well Riser: a. OD Well Riser: 2.38 inches. b. ID Well Riser: 2 inches.
c. Material: PVC
d. Installation Procedure: Thru Augers & Open Bedrock Hole
- 8. Annular Space Seal:
a. Material: high solids grout -
b. Installation Procedure: pour
- 9. Well Development Procedure: other - By Client
- 10. Drilling Method Used: percussion -
- 11. Annular Space Seal Bottom/Filter Seal Top: 53 ft.
- 12. Drilling Fluid Used: Yes Source: Air
- 13. Filter Pack Seal:
a. Material: bentonite pellet
b. Installation Procedure: Gravity Fed
c. Volume Added: 100 pounds
- 14. Bottom of Bentonite Seal/Filter Pack Top: 55 ft.
- 15. Depth to Top of Screen: 58 ft.
- 16. Screen:
a. Material: PVC
b. Installation Procedure: Thru Augers & Open Bedrock Hole
c. Slot Size: .01 inches. d. Screen Length: 20 ft.
- 17. Filter Pack:
a. Material: medium sand
b. Installation Procedure: Gravity Fed
- 18. Well Depth: 78 ft.
- 19. Bottom of Filter Pack: 78.5 ft.
- 20. Bottom of Borehole: 91 ft.
- 21. Backfill Material (below filter pack): Bentonite Pellets
- 22. Decontamination Procedures: None
- 23. Special Circumstances and Exceptions: Yes Variance Number: MW-07-05
- 24. WV Contractor License No. WV002350



Well No: 05-28/MW-7

Project: John E. Amos Power Plant

Well Tag: 0275-30-05

TTI Proj. No: 05639

Date Installed: 06/28/05

Client: GAI Consultants, Inc.

GPS Location: Latitude: N 39° 28' 44.1"

Longitude: W 081° 51' 15.5"

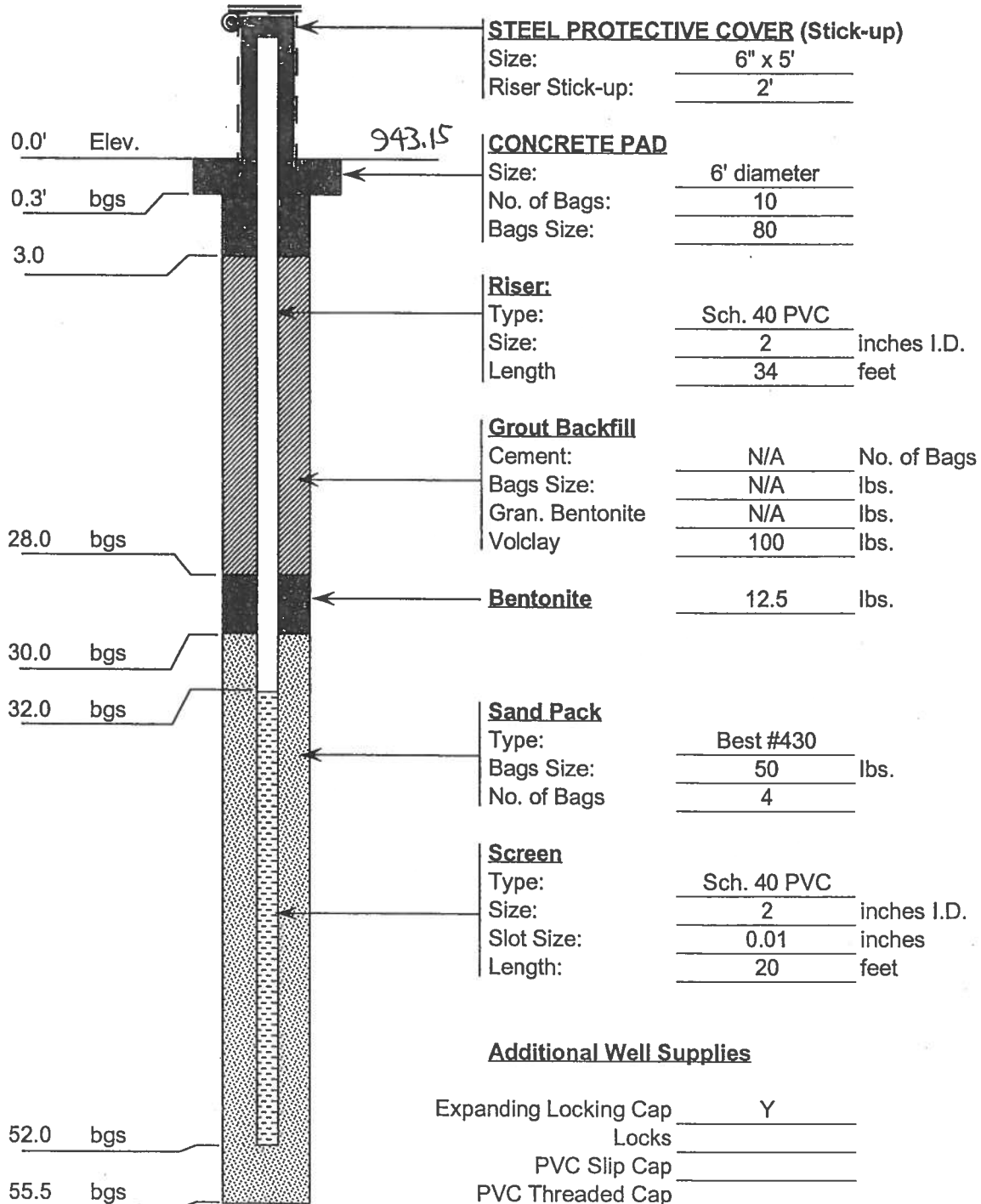

Additional Well Supplies

Expanding Locking Cap	Y
Locks	
PVC Slip Cap	
PVC Threaded Cap	
PVC Bottom Plug	Y
Auger Plugs	
No. of 55-gallon Drums Used	
No of Guard Posts Used	

**State of West Virginia
Department of Environmental Protection**

Monitoring Well Construction
Well Number: WV00275-0030-05

Site Name/Physical Address: Site: Proposed Landfill Line 1: Area 2/3 Line 2: Blue Lick Road City: Windfield State: WV Zip: 25213- County: Putnam	Well Registration No. WV00275-0030-05 Grid Location: a. Latitude: 38 28 44 .1 b. Longitude: 81 51 15 .5 c. Method Used: GPS	Purpose of Monitoring Well: Monitor Groundwater
Well Owner (Name, Firm, Address): Owner: Tom Carroll Line 1: John E. Amos Power Plant Line 2: 1530 Winfield Road City: Windfield State: WV Zip: 25213- Phone: 304-759-3156	Company/Project Well No.: 05639/05-28-MW-7 Installed By (Name, Firm, Address): Installer: Vern Curtis / Douglas Novotny Line 1: Terra Testing, Inc. Line 2: 260 Meadowlands Boulevard City: Washington State: PA Zip: 15301- Phone: 724-746-9100	Date Well Installed: 06/28/2005 Driller's WV Cert No. WV00275

Section B: (all number fields must be in decimal format)

- 1.Cap and Lock: YES
- 2.Protective Cover: Protective Cover Pipe
- 3.Monitoring Well Reference Point: 0 ft.
- 4.Borehole Diameter: 4 inches.
- 5.Ground Surface Seal:
a.Material: concrete
b.Installation Procedure: Hand Mixed
- 6.Surface Seal Bottom/Annular Space Top: 3 ft.
- 7.Well Riser: a.OD Well Riser: 2.38 inches. b.ID Well Riser: 2 inches.
c.Material: PVC
d.Installation Procedure: Thru Augers & Open Bedrock Hole
- 8.Annular Space Seal:
a.Material: high solids grout -
b.Installation Procedure: pour
- 9.Well Development Procedure: other - By Client
- 10.Drilling Method Used: percussion -
- 11.Annular Space Seal Bottom/Filter Seal Top: 28 ft.
- 12.Drilling Fluid Used: Yes Source: Air
- 13.Filter Pack Seal:
a.Material: bentonite pellet
b.Installation Procedure: Gravity Fed
c.Volume Added: 12.5 pounds
- 14.Bottom of Bentonite Seal/Filter Pack Top: 30 ft.
- 15.Depth to Top of Screen: 32 ft.
- 16.Screen:
a.Material: PVC
b.Installation Procedure: Thru Augers & Open Bedrock Hole
c.Slot Size: .01 inches. d.Screen Length: 20 ft.
- 17.Filter Pack:
a.Material: medium sand
b.Installation Procedure: Gravity Fed
- 18.Well Depth: 52 ft.
- 19.Bottom of Filter Pack: 55.5 ft.
- 20.Bottom of Borehole: 55.5 ft.
- 21.Backfill Material (below filter pack): sand
- 22.Decontamination Procedures: None
- 23.Special Circumstances and Exceptions: Yes Variance Number: MW-07-05
- 24.WV Contractor License No. WV002350

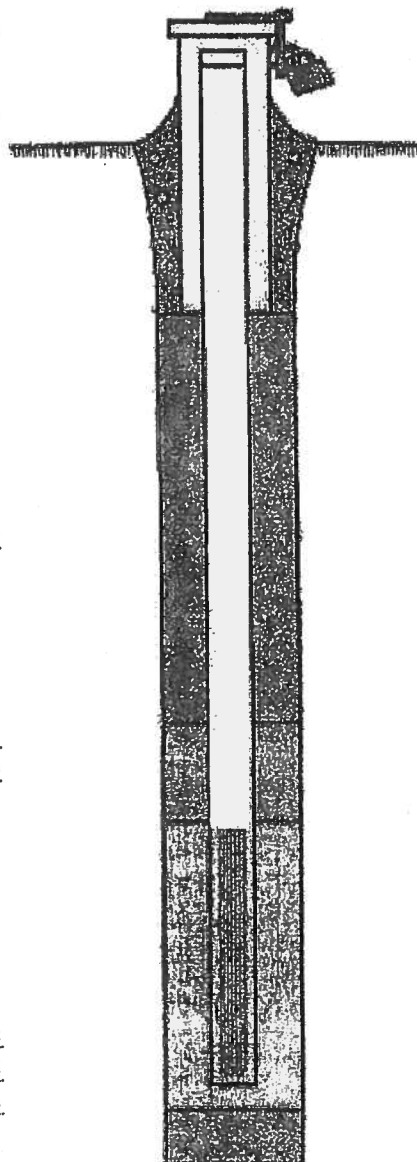

Well No: 05-34/MW-1108

Project: John E. Amos Power Plant

Well Tag: 0275-33-05

TTI Proj. No: 05639

Date Installed: 07/11/05

Client: GAI Consultants, Inc.

GPS Location: Latitude: N 38° 29' 09.3"

Longitude: W 081° 50' 57.5"

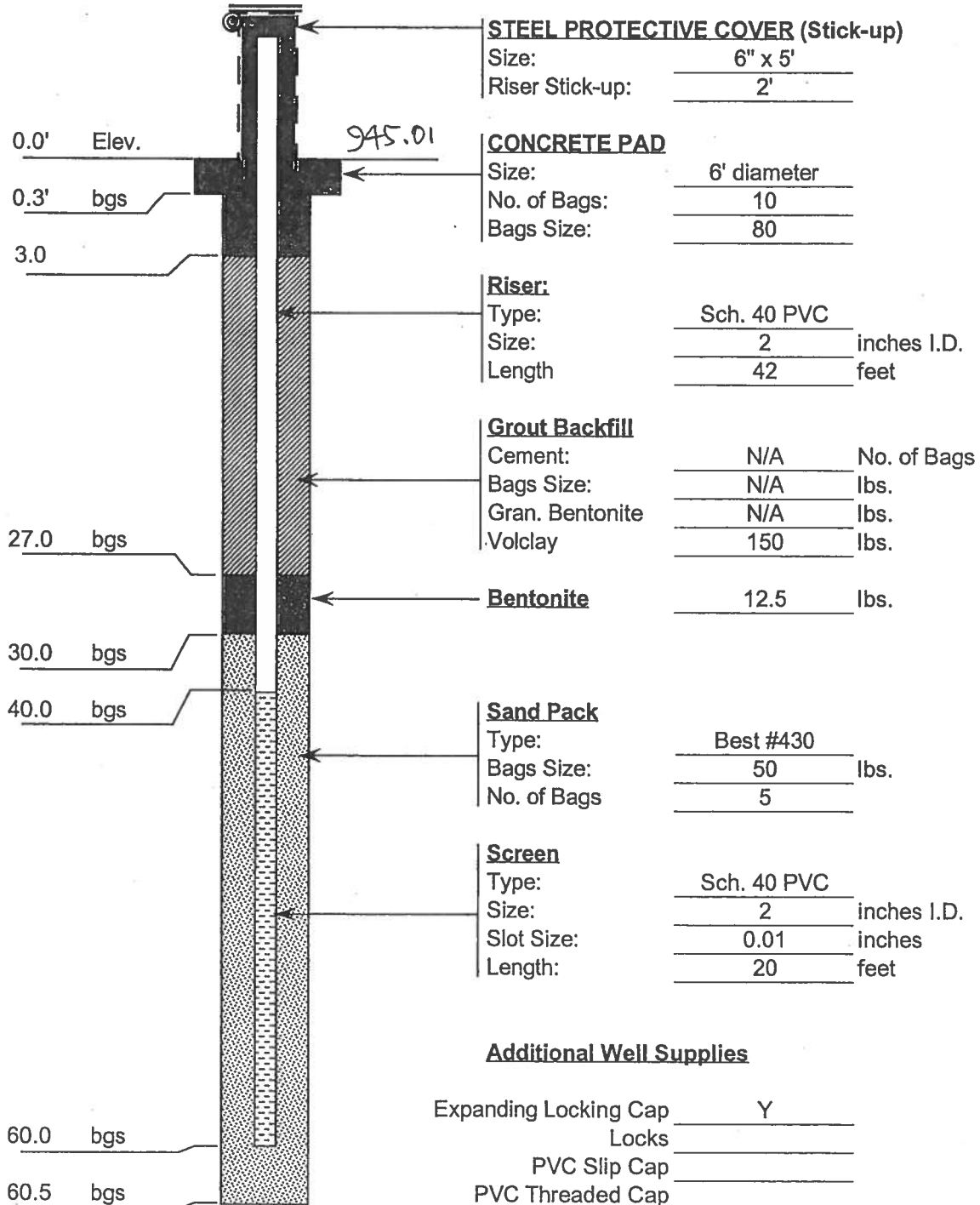

Additional Well Supplies

Expanding Locking Cap	Y
Locks	
PVC Slip Cap	
PVC Threaded Cap	
PVC Bottom Plug	Y
Auger Plugs	
No. of 55-gallon Drums Used	
No of Guard Posts Used	

**State of West Virginia
Department of Environmental Protection**

Monitoring Well Construction
Well Number: WV00275-0033-05

Site Name/Physical Address:		Well Registration No. WV00275-0033-05	Purpose of Monitoring Well:
Site: Proposed Landfill		Grid Location:	Monitor Groundwater
Line 1: Area 2/3		a. Latitude: 38 29 9 ..3	
Line 2: Blue Lick Road		b. Longitude: 81 50 57 ..3	
City: Windfield		c. Method Used: GPS	
State: WV			
Zip: 25213-		Company/Project Well No.:	
County: Putnam		05639/05-34-MW-11	
Well Owner (Name, Firm, Address):		Installed By (Name, Firm, Address):	Date Well Installed:
Owner: Tom Carroll		Installer: Vern Curtis / Douglas Novotny	07/11/2005
Line 1: John E. Amos Power Plant		Line 1: Terra Testing, Inc.	
Line 2: 1530 Winfield Road		Line 2: 260 Meadowlands Boulevard	
City: Windfield		City: Washington	Driller's WV Cert No.
State: WV		State: PA	WV00275
Zip: 25213-		Zip: 15301-	
Phone: 304-759-3156		Phone: 724-746-9100	

Section B: (all number fields must be in decimal format)

- 1. Cap and Lock: YES
- 2. Protective Cover: Protective Cover Pipe
- 3. Monitoring Well Reference Point: 0 ft.
- 4. Borehole Diameter: 4 inches.
- 5. Ground Surface Seal:
 - a. Material: concrete
 - b. Installation Procedure: Hand Mixed
- 6. Surface Seal Bottom/Annular Space Top: 3 ft.
- 7. Well Riser: a. OD Well Riser: 2.38 inches. b. ID Well Riser: 2 inches.
 - c. Material: PVC
 - d. Installation Procedure: Thru Augers & Open Bedrock Hole
- 8. Annular Space Seal:
 - a. Material: high solids grout -
 - b. Installation Procedure: pour
- 9. Well Development Procedure: other - By Client
- 10. Drilling Method Used: percussion -
- 11. Annular Space Seal Bottom/Filter Seal Top: 27 ft.
- 12. Drilling Fluid Used: Yes Source: Air
- 13. Filter Pack Seal:
 - a. Material: bentonite pellet
 - b. Installation Procedure: Gravity Fed
 - c. Volume Added: 12.5 pounds
- 14. Bottom of Bentonite Seal/Filter Pack Top: 30 ft.
- 15. Depth to Top of Screen: 40 ft.
- 16. Screen:
 - a. Material: PVC
 - b. Installation Procedure: Thru Augers & Open Bedrock Hole
 - c. Slot Size: .01 inches. d. Screen Length: 20 ft.
- 17. Filter Pack:
 - a. Material: medium sand
 - b. Installation Procedure: Gravity Fed
- 18. Well Depth: 60 ft.
- 19. Bottom of Filter Pack: 60.5 ft.
- 20. Bottom of Borehole: 60.5 ft.
- 21. Backfill Material (below filter pack): sand
- 22. Decontamination Procedures: None
- 23. Special Circumstances and Exceptions: Yes Variance Number: MW-07-05
- 24. WV Contractor License No. WV002350

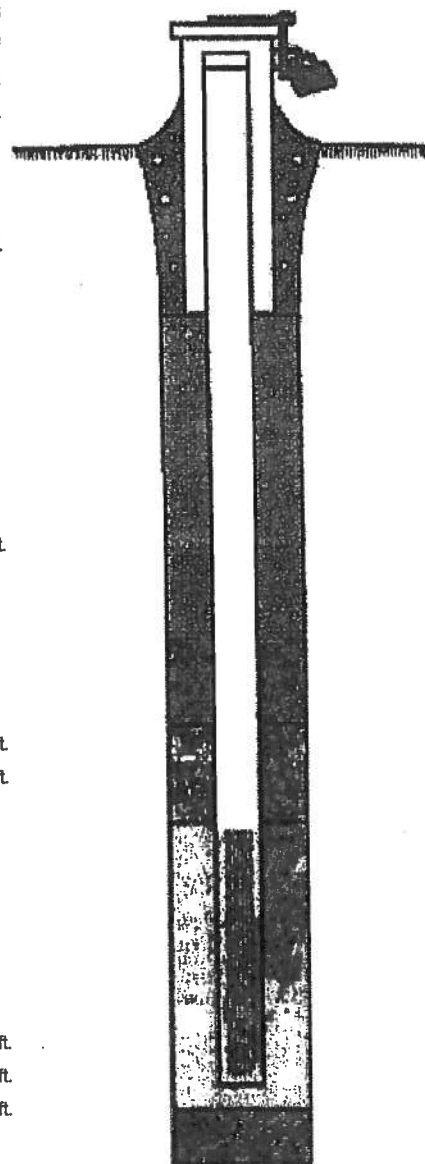

TESTING

Geotechnical & Environmental Drilling

Well No: 05-30/MW-9

Project: John E. Amos Power Plant

Well Tag: 0275-31-05

TTI Proj. No: 05639

Date Installed: 06/30/05

Client: GAI Consultants, Inc.

GPS Location: Latitude: N 38° 29' 29.1"

Longitude: W 081° 51' 8.8"

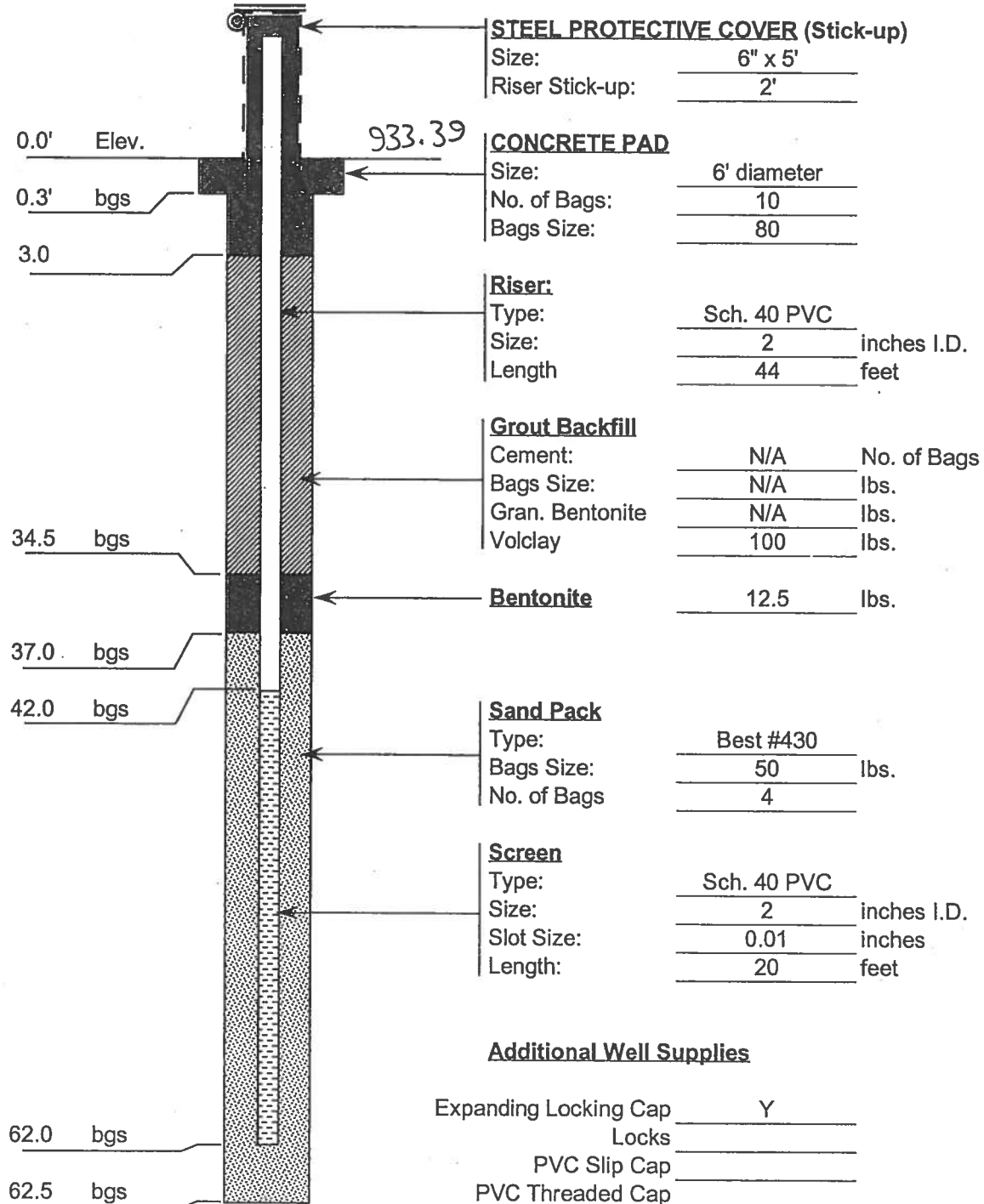

Expanding Locking Cap Y

Locks

PVC Slip Cap

PVC Threaded Cap

PVC Bottom Plug Y

Auger Plugs

No. of 55-gallon Drums Used

No of Guard Posts Used

**State of West Virginia
Department of Environmental Protection**

**Monitoring Well Construction
Well Number: WV00275-0031-05**

Site Name/Physical Address: Site: Proposed Landfill Line 1: Area 2/3 Line 2: Blue Lick Road City: Windfield State: WV Zip: 25213- County: Putnam	Well Registration No. WV00275-0031-05 Grid Location: a. Latitude: 38 29 29 .1 b. Longitude: 81 51 8 ..8 c. Method Used: GPS	Purpose of Monitoring Well: Monitor Groundwater
Well Owner (Name, Firm, Address): Owner: Tom Carroll Line 1: John E. Amos Power Plant Line 2: 1530 Winfield Road City: Windfield State: WV Zip: 25213- Phone: 304-759-3156	Company/Project Well No.: 05639/05-30-MW-9 Installed By (Name, Firm, Address): Installer: Vern Curtis / Douglas Novotny Line 1: Terra Testing, Inc. Line 2: 260 Meadowlands Boulevard City: Washington State: PA Zip: 15301- Phone: 724-746-9100	Date Well Installed: 06/30/2005 Driller's WV Cert No. WV00275

Section B: (all number fields must be in decimal format)

- 1. Cap and Lock: YES
- 2. Protective Cover: Protective Cover Pipe
- 3. Monitoring Well Reference Point: 0 ft.
- 4. Borehole Diameter: 4 inches.
- 5. Ground Surface Seal:
a. Material: concrete
b. Installation Procedure: Hand Mixed
- 6. Surface Seal Bottom/Annular Space Top: 3 ft.
- 7. Well Riser: a. OD Well Riser: 2.38 inches. b. ID Well Riser: 2 inches.
c. Material: PVC
d. Installation Procedure: Thru Augers & Open Bedrock Hole
- 8. Annular Space Seal:
a. Material: high solids grout -
b. Installation Procedure: pour
- 9. Well Development Procedure: other - By Client
- 10. Drilling Method Used: percussion -
- 11. Annular Space Seal Bottom/Filter Seal Top: 34.5 ft.
- 12. Drilling Fluid Used: Yes Source: Air
- 13. Filter Pack Seal:
a. Material: bentonite pellet
b. Installation Procedure: Gravity Fed
c. Volume Added: 12.5 pounds
- 14. Bottom of Bentonite Seal/Filter Pack Top: 37 ft.
- 15. Depth to Top of Screen: 42 ft.
- 16. Screen:
a. Material: PVC
b. Installation Procedure: Thru Augers & Open Bedrock Hole
c. Slot Size: .01 inches. d. Screen Length: 20 ft.
- 17. Filter Pack:
a. Material: medium sand
b. Installation Procedure: Gravity Fed
- 18. Well Depth: 62 ft.
- 19. Bottom of Filter Pack: 62.5 ft.
- 20. Bottom of Borehole: 62.5 ft.
- 21. Backfill Material (below filter pack): sand
- 22. Decontamination Procedures: None
- 23. Special Circumstances and Exceptions: Yes Variance Number: MW-07-05
- 24. WV Contractor License No. WV002350

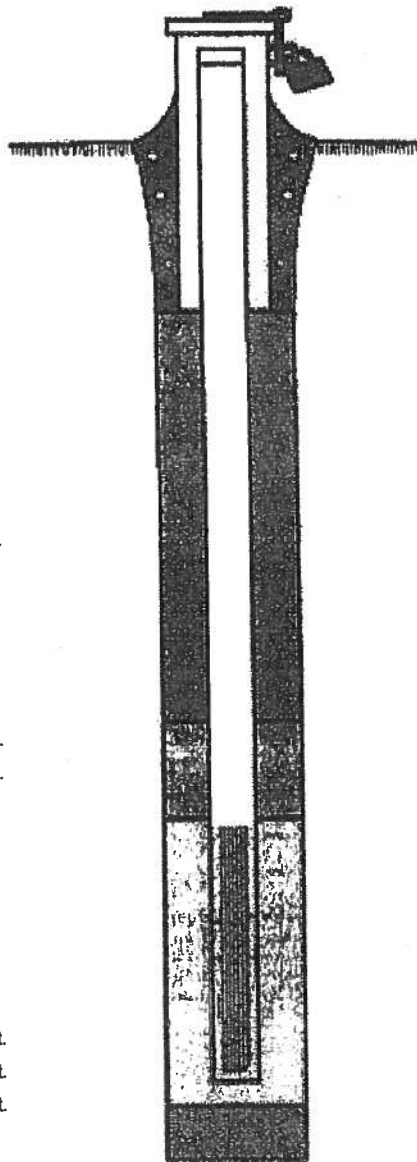

Well No: 05-31/MW-10

Project: John E. Amos Power Plant

Well Tag: 0275-32-05

TTI Proj. No: 05639

Date Installed: 07/06/05

Client: GAI Consultants, Inc.

GPS Location: Latitude: N 38° 29' 27.7"

Longitude: W 081° 51' 30.3"

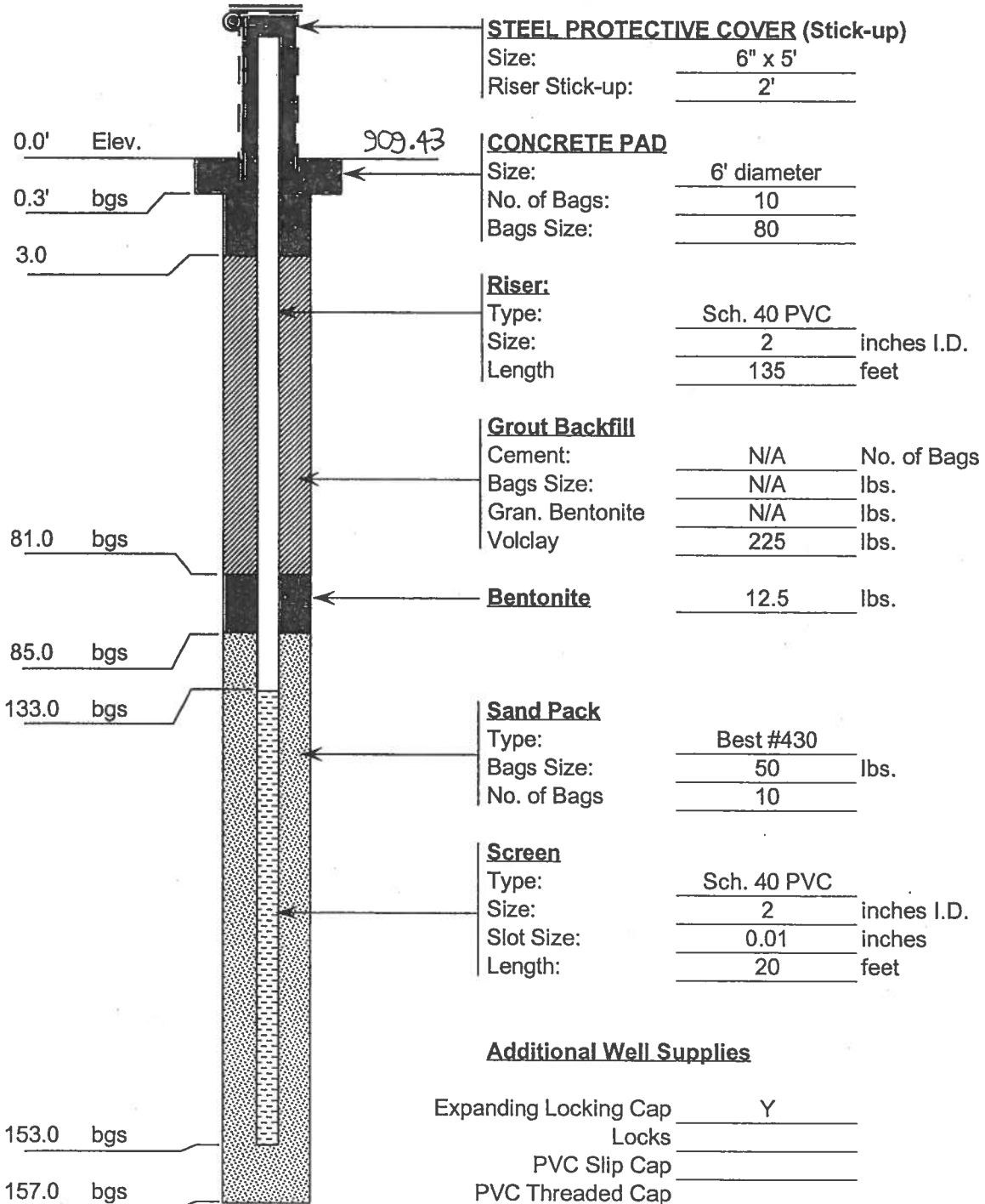

Additional Well Supplies

Expanding Locking Cap	Y
Locks	
PVC Slip Cap	
PVC Threaded Cap	
PVC Bottom Plug	Y
Auger Plugs	
No. of 55-gallon Drums Used	
No of Guard Posts Used	

**State of West Virginia
Department of Environmental Protection**

Monitoring Well Construction
Well Number: WV00275-0032-05

Site Name/Physical Address:		Well Registration No. WV00275-0032-05	Purpose of Monitoring Well:
Site:	Proposed Landfill	Grid Location:	Monitor Groundwater
Line 1:	Area 2/3	a. Latitude:	38 29 27 .7
Line 2:	Blue Lick Road	b. Longitude:	81 51 30 .3
City:	Windfield	c. Method Used:	GPS
State:	WV	Company/Project Well No.:	
Zip:	25213-	05839/05-31-MW-10	
County:	Putnam	Installed By (Name, Firm, Address):	
Well Owner (Name, Firm, Address):		Installer:	Date Well Installed:
Owner:	Tom Carroll	Yern Curtis / Douglas Novotny	07/06/2005
Line 1:	John E. Amos Power Plant	Line 1:	Terra Testing, Inc.
Line 2:	1530 Winfield Road	Line 2:	260 Meadowlands Boulevard
City:	Windfield	City:	Washington
State:	WV	State:	PA
Zip:	25213-	Zip:	15301-
Phone:	304-759-3156	Phone:	724-746-9100
		Driller's WV Cert No. WV00275	

Section B: (all number fields must be in decimal format)

- 1. Cap and Lock: YES
- 2. Protective Cover: Protective Cover Pipe
- 3. Monitoring Well Reference Point: 0 ft.
- 4. Borehole Diameter: 4 inches.
- 5. Ground Surface Seal:
 - a. Material: concrete
 - b. Installation Procedure: Hand Mixed
- 6. Surface Seal Bottom/Annular Space Top: 3 ft.
- 7. Well Riser: a. OD Well Riser: 2.38 inches. b. ID Well Riser: 2 inches.
 - c. Material: PVC
 - d. Installation Procedure: Thru Augers & Open Bedrock Hole
- 8. Annular Space Seal:
 - a. Material: high solids grout -
 - b. Installation Procedure: pour
- 9. Well Development Procedure: other - By Client
- 10. Drilling Method Used: percussion -
- 11. Annular Space Seal Bottom/Filter Seal Top: 81 ft.
- 12. Drilling Fluid Used: Yes Source: Air
- 13. Filter Pack Seal:
 - a. Material: bentonite pellet
 - b. Installation Procedure: Gravity Fed
 - c. Volume Added: 12.5 pounds
- 14. Bottom of Bentonite Seal/Filter Pack Top: 85 ft.
- 15. Depth to Top of Screen: 133 ft.
- 16. Screen:
 - a. Material: PVC
 - b. Installation Procedure: Thru Augers & Open Bedrock Hole
 - c. Slot Size: .01 inches. d. Screen Length: 20 ft.
- 17. Filter Pack:
 - a. Material: medium sand
 - b. Installation Procedure: Gravity Fed
- 18. Well Depth: 153 ft.
- 19. Bottom of Filter Pack: 157 ft.
- 20. Bottom of Borehole: 157 ft.
- 21. Backfill Material (below filter pack): sand
- 22. Decontamination Procedures: None
- 23. Special Circumstances and Exceptions: Yes Variance Number: MW-07-05
- 24. WV Contractor License No. WV002350

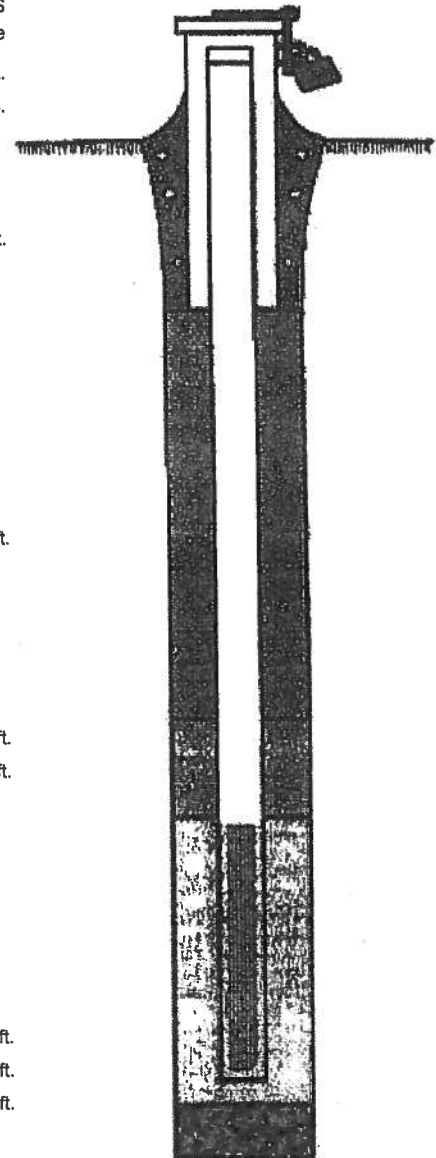





**WVDEP Monitoring Well &
Piezometer Closure Information**

Browser address bar: https://apps.dep.wv.gov/webapp_dep/securearea/mwcd_water Site Address

dep Abandonment Documentation Well Number: B-0505

>> Instructions for Use:  Locate Address 

Site Address

Site Name/Physical Address:

Site:

Line 1:

Line 2:

City:

State:

Zip:

County:

<< Return Home | Log Out

Taskbar: Windows Start button, Internet Explorer, File Explorer, Media Center, Outlook, Word. System tray: 1:30 PM, 9/15/2016

>> Instructions for Use:

Abandonment Information

Abandonment Type:

Borehole:
Monitoring Well: B-0505

Condition of Well:
Reason for Abandonment:
Abandonment Date: (mm/dd/yyyy)

Abandonment Procedure:

Material Used:
Procedure Used:
Total Well Depth: ft. Height of Standing Water in Well: ft. (if dry put 0)
Annular Space Type:
Decontamination Procedure:
Special Circumstances: Number:

Browser address bar: https://apps.dep.wv.gov/webapp_dep/securearea/mwcd_water Site Address

dep Abandonment Documentation
Well Number: B-0509

>> [Instructions for Use:](#) [Locate Address](#)

Site Address

Site Name/Physical Address:

Site:

Line 1:

Line 2:

City:

State:

Zip:

County:

<< Return Home | Log Out

Taskbar: 1:28 PM 9/15/2016

Browser address bar: https://apps.dep.wv.gov/webapp_dep/securearea/mwcd_water Abandonment Information

dep Abandonment Documentation
Well Number: B-0509

>> [Instructions for Use:](#)

Abandonment Information

Abandonment Type:
Borehole:
Monitoring Well: B-0509

Condition of Well:
Reason for Abandonment:
Abandonment Date: (mm/dd/yyyy)

Abandonment Procedure:
Material Used:
Procedure Used:
Total Well Depth: ft. Height of Standing Water in Well: ft. (if dry put 0)
Annular Space Type:
Decontamination Procedure:
Special Circumstances: Number:

<< Return Home | Log Out

Windows taskbar: 1:28 PM 9/15/2016

Browser address bar: https://apps.dep.wv.gov/webapp_dep/securearea/mwcd_water Site Address

dep Abandonment Documentation
Well Number: B-0511

>> [Instructions for Use:](#)  [Locate Address](#)

Site Address

Site Name/Physical Address:

Site:

Line 1:

Line 2:

City:

State:

Zip:

County:

<< Return Home | Log Out

Taskbar: Windows Start button, Internet Explorer, File Explorer, Media Center, Outlook, Word, Mail, System tray: 1:39 PM, 9/15/2016

Browser address bar: https://apps.dep.wv.gov/webapp_dep/securearea/mwcd_water Abandonment Information

dep Abandonment Documentation
Well Number: B-0511

>> [Instructions for Use:](#)

Abandonment Information

Abandonment Type:
Borehole:
Monitoring Well: B-0511

Condition of Well:
Reason for Abandonment:
Abandonment Date: (mm/dd/yyyy)



Abandonment Procedure:
Material Used:
Procedure Used:
Total Well Depth: ft. Height of Standing Water in Well: ft. (if dry put 0)
Annular Space Type:
Decontamination Procedure:
Special Circumstances: Number:

<< Return Home | Log Out

Windows taskbar: 1:39 PM 9/15/2016

Browser address bar: https://apps.dep.wv.gov/webapp_dep/securearea/mwcd_water Site Address

dep Abandonment Documentation
Well Number: B-0512

>> [Instructions for Use:](#)  [Locate Address](#) 

Site Address

Site Name/Physical Address:

Site:

Line 1:

Line 2:

City:

State:

Zip:

County:

<< Return Home | Log Out

Taskbar: Windows Start button, Internet Explorer, File Explorer, VLC, Outlook, Word, System tray: 1:33 PM, 9/15/2016

>> Instructions for Use:

Abandonment Information

Abandonment Type:

Borehole:
Monitoring Well: B-0512

Condition of Well:
Reason for Abandonment:
Abandonment Date: (mm/dd/yyyy)

Abandonment Procedure:

Material Used:
Procedure Used:
Total Well Depth: ft. Height of Standing Water in Well: ft. (if dry put 0)
Annular Space Type:
Decontamination Procedure:
Special Circumstances: Number:

Browser address bar: https://apps.dep.wv.gov/webapp_dep/securearea/mwcd_water Site Address

dep Abandonment Documentation
Well Number: B-0513

>> [Instructions for Use:](#)  [Locate Address](#)

Site Address

Site Name/Physical Address:

Site:

Line 1:

Line 2:

City:

State:

Zip:

County:

<< Return Home | Log Out

Windows taskbar: 1:34 PM 9/15/2016

https://apps.dep.wv.gov/webapp_dep/securearea/mwcd_water Abandonment Information

dep Abandonment Documentation
Well Number: B-0513

>> Instructions for Use:

Abandonment Information

Abandonment Type:
Borehole:
Monitoring Well: B-0513

Condition of Well: Good
Reason for Abandonment: 1" piezometer is no longer in use.
Abandonment Date: 4/16/2013 (mm/dd/yyyy)



Abandonment Procedure:
Material Used: 3/8" Coated Pellets / 10 lbs.
Procedure Used: Gravity / Pulled protector / Dug 3" / Placed clay cap
Total Well Depth: 14 ft. Height of Standing Water in Well: 5 ft. (if dry put 0)
Annular Space Type: Impermeable
Decontamination Procedure: Liquid Nox
Special Circumstances: No Number:

<< Return Home | Log Out

1:34 PM 9/15/2016

Browser address bar: https://apps.dep.wv.gov/webapp_dep/securearea/mwcd_water Site Address

dep Abandonment Documentation
Well Number: B-0523

>> [Instructions for Use:](#)  [Locate Address](#) 

Site Address

Site Name/Physical Address:

Site:

Line 1:

Line 2:

City:

State:

Zip:

County:

<< Return Home | Log Out

Windows taskbar: 1:34 PM 9/15/2016

>> Instructions for Use:

Abandonment Information

Abandonment Type:

Borehole:
Monitoring Well: B-0523



Condition of Well: Good
Reason for Abandonment: 1" piezometer is no longer in use.
Abandonment Date: 4/16/2013 (mm/dd/yyyy)

Abandonment Procedure:

Material Used: 3/8" Coated Pellets / 15 lbs.
Procedure Used: Gravity / Pulled protector / Dug 3' / Placed clay cap
Total Well Depth: 50 ft. Height of Standing Water in Well: 22 ft. (if dry put 0)
Annular Space Type: Impermeable
Decontamination Procedure: Liquid Nox
Special Circumstances: No Number:

Browser address bar: https://apps.dep.wv.gov/webapp_dep/securearea/mwcd_water Site Address

dep Abandonment Documentation
Well Number: B-0524

>> [Instructions for Use:](#)  [Locate Address](#) 

Site Address

Site Name/Physical Address:

Site:

Line 1:

Line 2:

City:

State:

Zip:

County:

<< Return Home | Log Out

Windows taskbar: 1:36 PM 9/15/2016

>> Instructions for Use:

Abandonment Information

Abandonment Type:

Borehole:
Monitoring Well: B-0524

Condition of Well:
Reason for Abandonment:
Abandonment Date: (mm/dd/yyyy)

Abandonment Procedure:

Material Used:
Procedure Used:
Total Well Depth: ft. Height of Standing Water in Well: ft. (if dry put 0)
Annular Space Type:
Decontamination Procedure:
Special Circumstances: Number:

Browser address bar: https://apps.dep.wv.gov/webapp_dep/securearea/mwcd_water Site Address

dep Abandonment Documentation
Well Number: BankeR75-2005-01

>> [Instructions for Use:](#) [Locate Address](#)

Site Address

Site Name/Physical Address:

Site:

Line 1:

Line 2:

City:

State:

Zip:

County:

<< Return Home | Log Out

Taskbar: 1:42 PM 9/15/2016

https://apps.dep.wv.gov/webapp_dep/securearea/mwcd_water Abandonment Information

dep Abandonment Documentation
Well Number: BankeR75-2005-01

>> Instructions for Use:

Abandonment Information

Abandonment Type:
Borehole:
Monitoring Well: BankeR75-2005-01

Condition of Well: Good
Reason for Abandonment: No longer in use
Abandonment Date: 4/25/2007 (mm/dd/yyyy)

Abandonment Procedure:
Material Used: 14.8 lbs of 3/8 Bentonite Coated Pellets
Procedure Used: Casing cut 30" below surface and dropped 3/8 Ber
Total Well Depth: 51.17 ft. Height of Standing Water in Well: 19.85 ft. (if dry put 0)
Annular Space Type: Impermeable
Decontamination Procedure: None
Special Circumstances: No Number: 05-01

<< Return Home | Log Out

1:42 PM 9/15/2016

Browser address bar: https://apps.dep.wv.gov/webapp_dep/securearea/mwcd_water Site Address

dep Abandonment Documentation
Well Number: BankeR75-2005-02

>> [Instructions for Use:](#) [Locate Address](#)

Site Address

Site Name/Physical Address:

Site:

Line 1:

Line 2:

City:

State:

Zip:

County:

<< Return Home | Log Out

Windows taskbar: 1:41 PM 9/15/2016

>> Instructions for Use:

Abandonment Information

Abandonment Type:

Borehole:
Monitoring Well: BankeR75-2005-02

Condition of Well:
Reason for Abandonment:
Abandonment Date: (mm/dd/yyyy)

Abandonment Procedure:

Material Used:
Procedure Used:
Total Well Depth: ft. Height of Standing Water in Well: ft. (if dry put 0)
Annular Space Type:
Decontamination Procedure:
Special Circumstances: Number:

Browser address bar: https://apps.dep.wv.gov/webapp_dep/securearea/mwcd_water Site Address

dep Abandonment Documentation Well Number: MW-3R

>> [Instructions for Use:](#) [Locate Address](#)

Site Address

Site Name/Physical Address:

Site:

Line 1:

Line 2:

City:

State:

Zip:

County:

<< Return Home | Log Out

Taskbar: 1:32 PM 9/15/2016

>> Instructions for Use:

Abandonment Information

Abandonment Type:

Borehole:
Monitoring Well: MW-3R

Condition of Well: Good

Reason for Abandonment: No longer in use.

Abandonment Date: 4/16/2013 (mm/dd/yyyy)

Abandonment Procedure:

Material Used: 3/8" Coated Pellets - 8 lbs.

Procedure Used: Pulled pump / Gravity pellets / Pulled protector / D

Total Well Depth: 50 ft. Height of Standing Water in Well: 12 ft. (if dry put 0)

Annular Space Type: Impermeable

Decontamination Procedure: Liquid Nox

Special Circumstances: No Number:

<< Return

Home | Log Out

Browser address bar: https://apps.dep.wv.gov/webapp_dep/securearea/mwcd_water Site Address

dep Abandonment Documentation
Well Number: P-0520

>> [Instructions for Use:](#)  [Locate Address](#)

Site Address

Site Name/Physical Address:

Site:

Line 1:

Line 2:

City:

State:

Zip:

County:

<< Return Home | Log Out

Taskbar: Windows Start button, Internet Explorer, File Explorer, VLC, Outlook, Word, Skype, System tray: 1:37 PM, 9/15/2016

Browser address bar: https://apps.dep.wv.gov/webapp_dep/securearea/mwcd_water Abandonment Information

dep Abandonment Documentation
Well Number: P-0520

>> [Instructions for Use:](#)

Abandonment Information

Abandonment Type:
Borehole:
Monitoring Well: P-0520

Condition of Well:
Reason for Abandonment:
Abandonment Date: (mm/dd/yyyy)

Abandonment Procedure:
Material Used:
Procedure Used:
Total Well Depth: ft. Height of Standing Water in Well: ft. (if dry put 0)
Annular Space Type:
Decontamination Procedure:
Special Circumstances: Number:

<< Return Home | Log Out

Windows taskbar: 1:37 PM 9/15/2016

Browser address bar: https://apps.dep.wv.gov/webapp_dep/securearea/mwcd_water Site Address

dep Abandonment Documentation Well Number: P-0525

>> [Instructions for Use:](#) [Locate Address](#)

Site Address

Site Name/Physical Address:

Site:

Line 1:

Line 2:

City:

State:

Zip:

County:

<< Return Home | Log Out

Taskbar: 1:37 PM 9/15/2016

>> Instructions for Use:

Abandonment Information

Abandonment Type:

Borehole:
Monitoring Well: P-0525

Condition of Well:
Reason for Abandonment:
Abandonment Date: (mm/dd/yyyy)

Abandonment Procedure:

Material Used:
Procedure Used:
Total Well Depth: ft. Height of Standing Water in Well: ft. (if dry put 0)
Annular Space Type:
Decontamination Procedure:
Special Circumstances: Number:



**WVDEP Monitoring Well &
Piezometer Pending Closure
Information**

WVDEP Monitoring Well Piezometer Pending Closure Information
 AEP Amos Generating Plant - FGD Landfill
 Winfield, West Virginia



Facility	Reg #	Type	City	County	Well #	Latitude			Longitude			Method	Owner	Phone #	Date of Finish	Abandon Date	Reason for Install	Driller First Name	Driller Last Name	Certificate #
Proposed Landfill - Amos Power Plant	NA	AMW	Winfield	Putnam	B-0508	38	29	7.1	81	51	22.9	GPS	Amos Power Plant	304-759-3156	5/3/2005	8/22/2006	NA	Marvin	Roush	00015
Proposed Landfill - Amos Power Plant	NA	AMW	Winfield	Putnam	05639/05-28 MW 7	38	28	44.1	81	51	15.5	GPS	Amos Power Plant	304-759-3156	6/28/2005	8/22/2006	NA	Marvin	Roush	00015

Notes:
 Information provided by West Virginia Department of Environmental Protection as pending database upload.
 NA - Not Applicable
 GPS - Global Positioning System



**WVDEP Oil & Gas Well Closure
Information**

WVDEP Office of Oil and Gas - Well Search

Disclaimer: Per §22-6-6. Permit required for all well work; permit fee; application; soil erosion control plan.

(a) It is unlawful for any person to commence any well work, including site preparation work, which involves any disturbance of land, without first securing a well work permit from the director of the WVDEP Office of Oil and Gas.

The appearance of an API number on the web page does not signify that a permit has been issued. The API number is used as a tracking mechanism until the permit has been issued. Under no circumstances should well work be commenced without a signed permit.

Well API	Operator	Surface Owner	Well Number	Well Status	Well Type	Last Permit Issue Date
4707900611	MEADOWS Jr, S. L. PRODUCTION Inc.	APPALACHIAN POWER COMPANY	616	Plugged	Vertical	09/21/2007

The operator listed above is the CURRENT operator of the well.

This operator may or may not have recorded production for this well for the years listed below.

The production listed below spans this well's 5 last years, regardless of the operator who originally recorded a particular year's production numbers.

Well Lifetime Gas Production

No Production Reported

Well Lifetime Oil Production

No Production Reported

Well Lifetime NGL Production

No Production Reported

The West Virginia Department of Environmental Protection (WVDEP) makes oil and gas well information and production data available to the general public through this internet service free of charge.

The oil and gas related data originate from the information reported to the Office of Oil and Gas at WVDEP by West Virginia oil and gas operators. The WVDEP does not guarantee their accuracy, precision, or completeness.

Neither the West Virginia Department of Environmental Protection nor its staff members are liable or responsible for any damage or loss resulting from the use of these data or from inaccuracies contained in the data.

We encourage you to report any problems, inconsistencies, or errors noted in using this data to the Office of Oil and Gas so that we can correct them and provide better service.

Office of Oil and Gas
Department of Environmental Protection
601 57th St
Charleston, West Virginia 25304
Phone: (304) 926-0499
Fax: (304) 926-0452

WVDEP Office of Oil and Gas - Well Search

Disclaimer: Per §22-6-6. Permit required for all well work; permit fee; application; soil erosion control plan.

(a) It is unlawful for any person to commence any well work, including site preparation work, which involves any disturbance of land, without first securing a well work permit from the director of the WVDEP Office of Oil and Gas.

The appearance of an API number on the web page does not signify that a permit has been issued. The API number is used as a tracking mechanism until the permit has been issued. Under no circumstances should well work be commenced without a signed permit.

Well API	Operator	Surface Owner	Well Number	Well Status	Well Type	Last Permit Issue Date
4707900660	MEADOWS Jr, S. L. PRODUCTION Inc.	AMERICAN ELECTRIC POWER	2	Plugged	Vertical	09/08/2006

The operator listed above is the CURRENT operator of the well.

This operator may or may not have recorded production for this well for the years listed below.

The production listed below spans this well's 5 last years, regardless of the operator who originally recorded a particular year's production numbers.

Well Lifetime Gas Production

No Production Reported

Well Lifetime Oil Production

No Production Reported

Well Lifetime NGL Production

No Production Reported

The West Virginia Department of Environmental Protection (WVDEP) makes oil and gas well information and production data available to the general public through this internet service free of charge.

The oil and gas related data originate from the information reported to the Office of Oil and Gas at WVDEP by West Virginia oil and gas operators. The WVDEP does not guarantee their accuracy, precision, or completeness.

Neither the West Virginia Department of Environmental Protection nor its staff members are liable or responsible for any damage or loss resulting from the use of these data or from inaccuracies contained in the data.

We encourage you to report any problems, inconsistencies, or errors noted in using this data to the Office of Oil and Gas so that we can correct them and provide better service.

Office of Oil and Gas
Department of Environmental Protection
601 57th St
Charleston, West Virginia 25304
Phone: (304) 926-0499
Fax: (304) 926-0452

WVDEP Office of Oil and Gas - Well Search

Disclaimer: Per §22-6-6. Permit required for all well work; permit fee; application; soil erosion control plan.

(a) It is unlawful for any person to commence any well work, including site preparation work, which involves any disturbance of land, without first securing a well work permit from the director of the WVDEP Office of Oil and Gas.

The appearance of an API number on the web page does not signify that a permit has been issued. The API number is used as a tracking mechanism until the permit has been issued. Under no circumstances should well work be commenced without a signed permit.

Well API	Operator	Surface Owner	Well Number	Well Status	Well Type	Last Permit Issue Date
4707900722	MEADOWS Jr, S. L. PRODUCTION Inc.	AMERICAN ELECTRIC POWER	3	Plugged	Vertical	09/08/2006

The operator listed above is the CURRENT operator of the well.

This operator may or may not have recorded production for this well for the years listed below.

The production listed below spans this well's 5 last years, regardless of the operator who originally recorded a particular year's production numbers.

Well Lifetime Gas Production

No Production Reported

Well Lifetime Oil Production

No Production Reported

Well Lifetime NGL Production

No Production Reported

The West Virginia Department of Environmental Protection (WVDEP) makes oil and gas well information and production data available to the general public through this internet service free of charge.

The oil and gas related data originate from the information reported to the Office of Oil and Gas at WVDEP by West Virginia oil and gas operators. The WVDEP does not guarantee their accuracy, precision, or completeness.

Neither the West Virginia Department of Environmental Protection nor its staff members are liable or responsible for any damage or loss resulting from the use of these data or from inaccuracies contained in the data.

We encourage you to report any problems, inconsistencies, or errors noted in using this data to the Office of Oil and Gas so that we can correct them and provide better service.

Office of Oil and Gas
Department of Environmental Protection
601 57th St
Charleston, West Virginia 25304
Phone: (304) 926-0499
Fax: (304) 926-0452

APPENDIX B

Banks Well Report



Prepared for:

ARCADIS U.S., INC.-Columbus
630 Plaza Drive, Suite 600
Highlands Ranch, CO 80129



Water Well Report

AEP Water Well Inventory

AMOS PLANT

1530 WINFIELD ROAD

WINFIELD, WV

PUTNAM County

PO #: OH015976.0004

ES-112028

Wednesday, September 10, 2014

Table of Contents *AEP Water Well Inventory*



Geographic Summary	3
Maps	
Summary Map - 0.5 Mile Buffer	4
Topographic Overlay Map - 0.5 Mile Buffer	5
Current Imagery Overlay Map - 0.5 Mile Buffer	6
Water Well Details	7
Database Definitions and Sources	8
Disclaimer	9

Geographic Summary *AEP Water Well Inventory*



Location	
PUTNAM County, WV	
Target location is 0.316 square miles and has a 6.52 mile perimeter	

Coordinates	
Longitude & Latitude in Degrees Minutes Seconds	NA
Longitude & Latitude in Decimal Degrees	NA
X and Y in UTM	NA

Elevation	
NA	

Zip Codes Searched	
Search Distance	Zip Codes (historical zip codes included)
Target Property	25213, 25070, 25109, 25124
0.5 miles	25143, 25159, 25213, 25070, 25109, 25124, 25560

Topos Searched	
Search Distance	Topo Name
Target Property	Saint Albans (1980)
0.5 miles	Saint Albans (1980)

Summary Map - 0.5 Mile Buffer

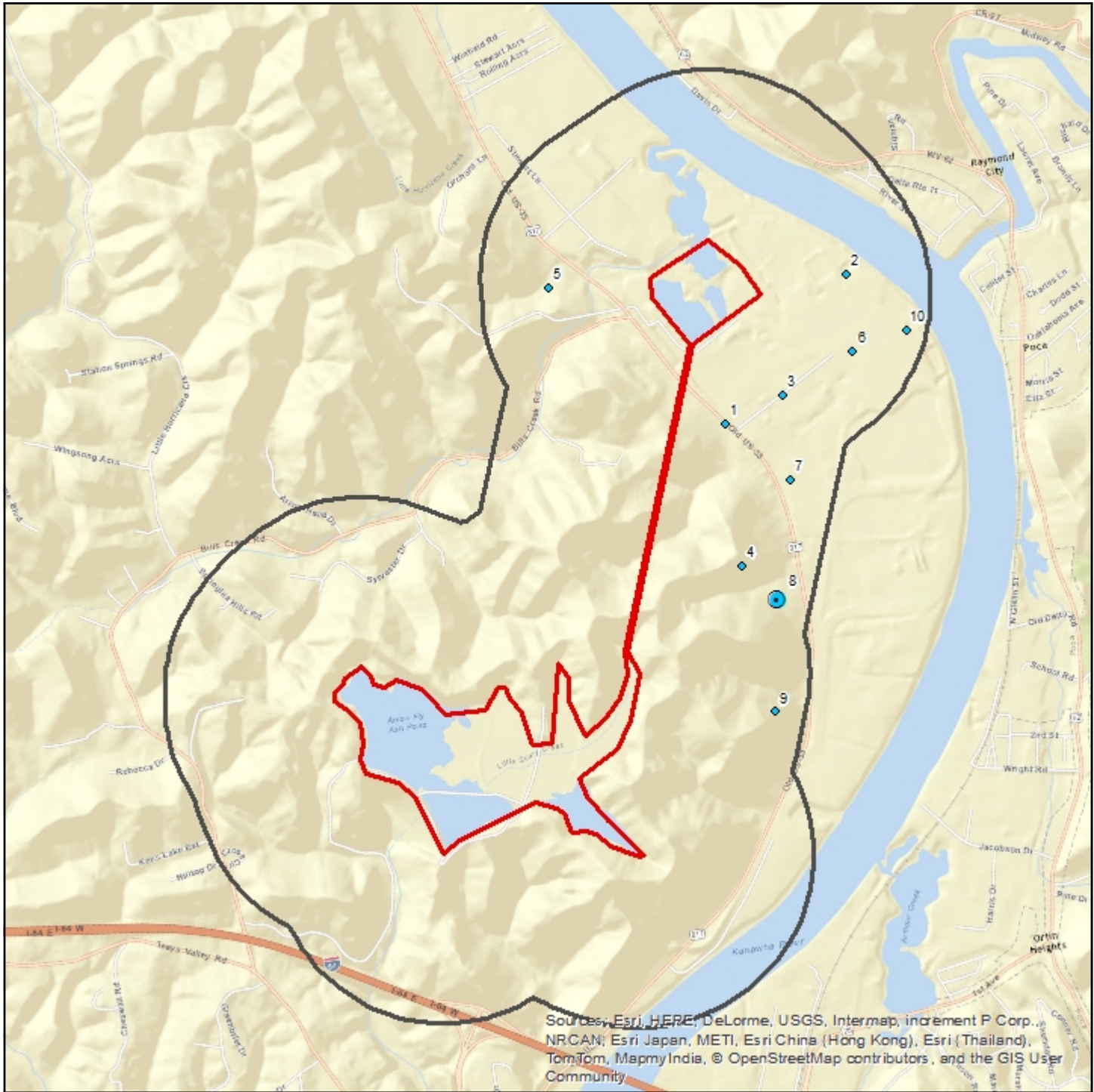

AEP Water Well Inventory

- Well
- Well Cluster
- Target Property
- Search Buffer

1 : 27,000
 1 inch = 0.426 miles
 1 inch = 2250 feet
 1 centimeter = 0.270 kilometers
 1 centimeter = 270 meters



Lambert Conformal Conic Projection
 1983 North American Datum
 First Standard Parallel: 33° 00' North
 Second Standard Parallel: 45° 00' North
 Central Meridian: 96° 00' West
 Latitude of Origin: 39° 00' North

Topographic Overlay Map - 0.5 Mile Buffer

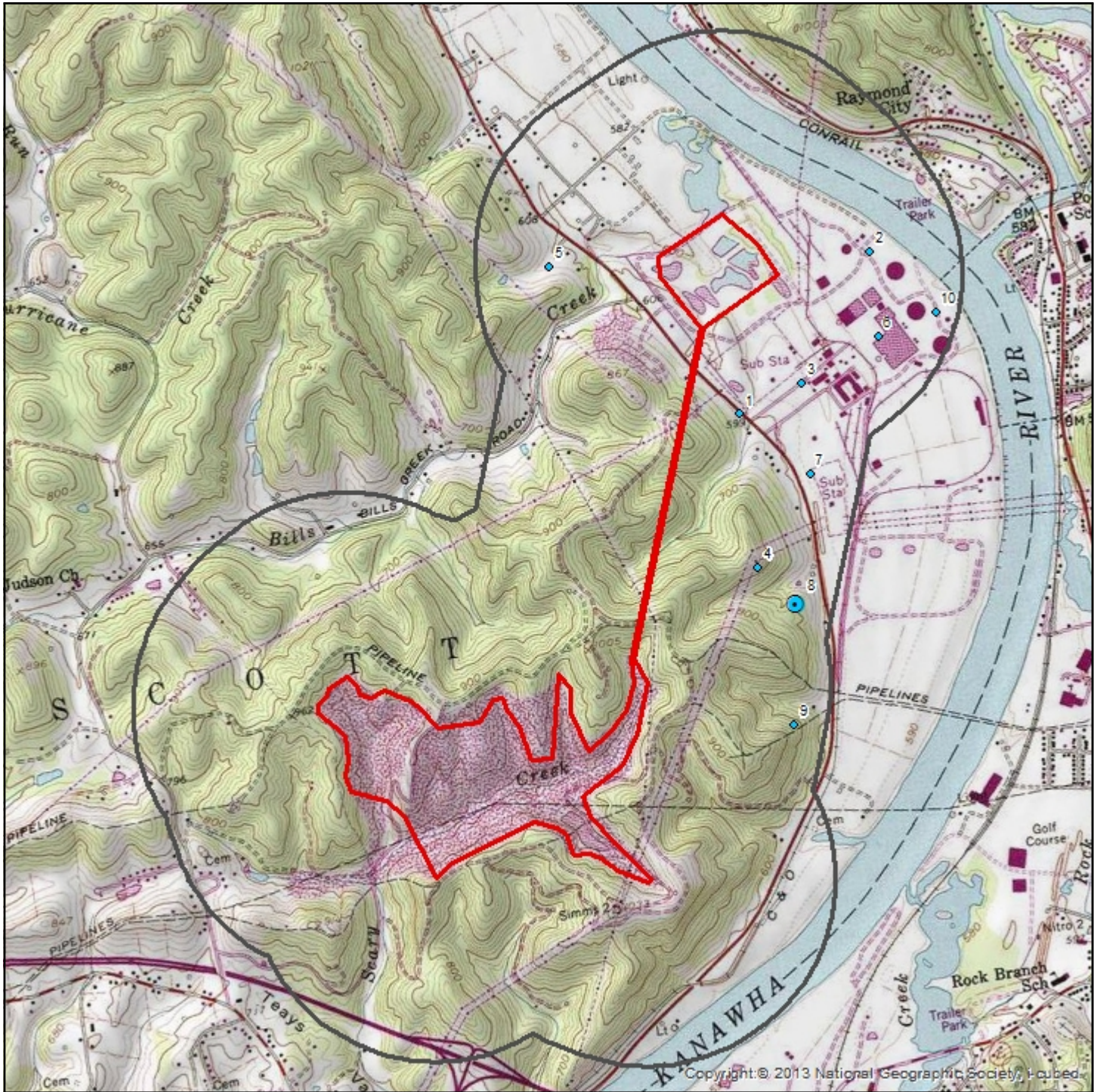

AEP Water Well Inventory

- Well
- Well Cluster

- Target Property
- Search Buffer

Target Property Quad Name(s)
Saint Albans (1980)

1 : 25,000
1 inch = 0.395 miles
1 inch = 2083 feet

Lambert Conformal Conic Projection
1983 North American Datum
First Standard Parallel: 33° 00' North
Second Standard Parallel: 45° 00' North
Central Meridian: 96° 00' West
Latitude of Origin: 39° 00' North



Current Imagery Overlay Map - 0.5 Mile Buffer

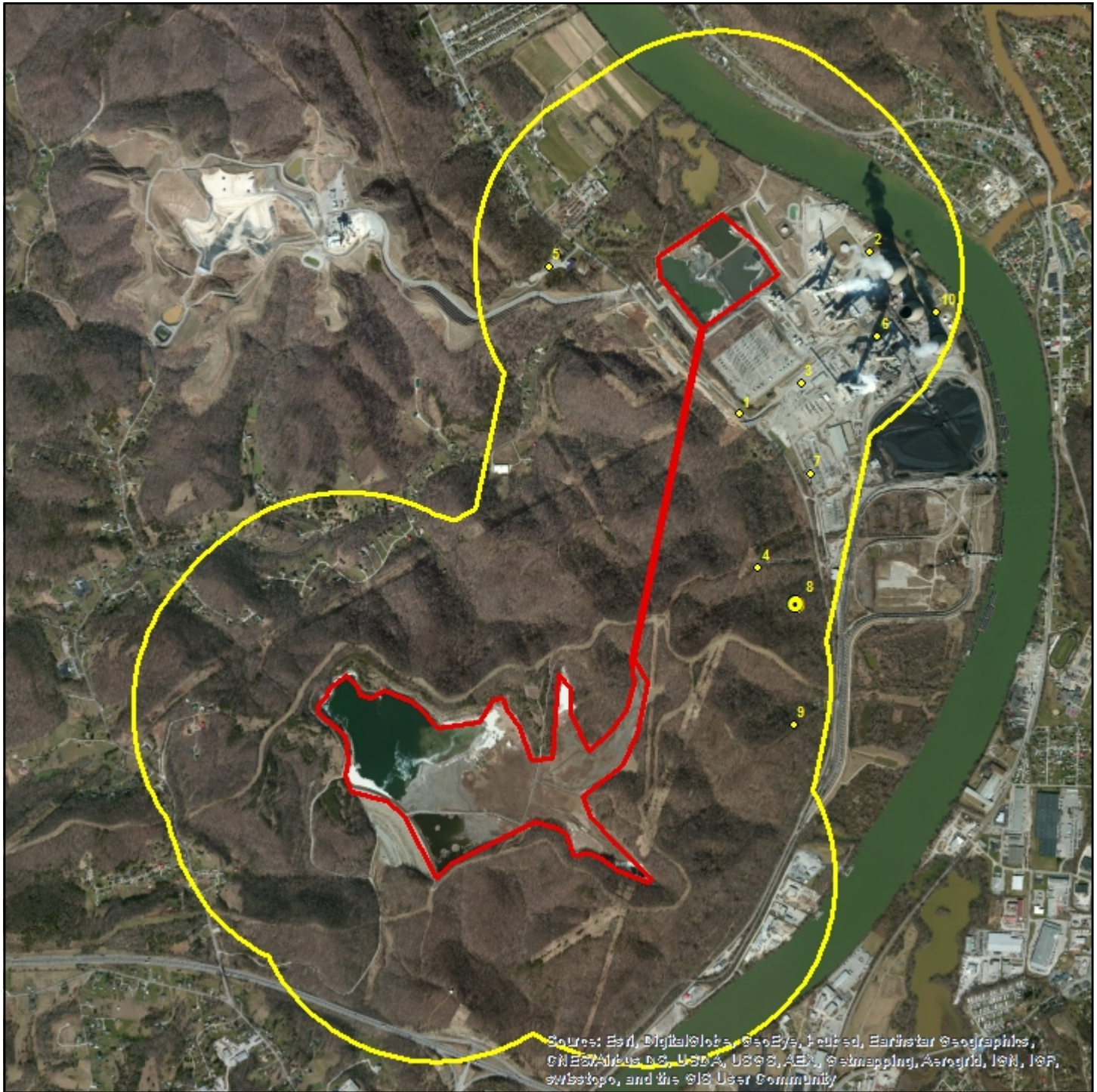

Sources: Esri, DigitalGlobe, GeoEye, IGN, Earthstar Geographics, CNES/Airbus DS, USDA, USGS, AeroX, GeoMapping, AeroGRID, IGN, ICF, swisstopo, and the GIS User Community

AEP Water Well Inventory

- Well
- Well Cluster
- Target Property
- Search Buffer

1 : 25,000
 1 inch = 0.395 miles
 1 inch = 2083 feet
 1 centimeter = 0.250 kilometers
 1 centimeter = 250 meters



Lambert Conformal Conic Projection
 1983 North American Datum
 First Standard Parallel: 33° 00' North
 Second Standard Parallel: 45° 00' North
 Central Meridian: 96° 00' West
 Latitude of Origin: 39° 00' North

Water Well Details *AEP Water Well Inventory*



Map ID	Source ID	Dataset	Owner of Well	Type of Well	Depth Drilled	Completion Date	Longitude	Latitude	Elevation	Driller's Logs
1	USGS-382818081495101	WW USGS	USGS	Not Reported	15	01/01/1960	-81.830687	38.471758	603 ft	N/A
2	USGS-382838081492301	WW USGS	USGS	Not Reported	20	01/01/1960	-81.822909	38.477314	587 ft	N/A
3	USGS-382821081493901	WW USGS	USGS	Not Reported	25	01/01/1960	-81.827354	38.472591	587 ft	N/A
4	USGS-382756081495201	WW USGS	USGS	Not Reported	15	01/01/1960	-81.830965	38.465647	828 ft	N/A
5	USGS-382843081502101	WW USGS	USGS	Not Reported	128	01/01/1938	-81.839021	38.478702	616 ft	N/A
6	USGS-382826081492401	WW USGS	USGS	Not Reported	56	01/01/1960	-81.823187	38.47398	591 ft	N/A
7	USGS-382808081494001	WW USGS	USGS	Not Reported	25	01/01/1960	-81.827631	38.46898	587 ft	N/A
8	USGS-382750081494601	WW USGS	USGS	Not Reported	57	01/01/1930	-81.829298	38.46398	703 ft	N/A
8	USGS-382750081494602	WW USGS	USGS	Not Reported	28	01/01/1915	-81.829298	38.46398	703 ft	N/A
9	USGS-382733081495001	WW USGS	USGS	Not Reported	37	01/01/1920	-81.830409	38.459258	748 ft	N/A
10	USGS-382828081491301	WW USGS	USGS	Not Reported	20	01/01/1960	-81.820131	38.474536	589 ft	N/A

Well Summary

Water Well Dataset	# of Wells
WW USGS	11
Total Count	11

Dataset Descriptions and Sources *AEP Water Well Inventory*



Dataset	Source	Dataset Description	Update Schedule	Data Requested	Data Obtained	Data Updated	Source Updated
WV WW - West Virginia Water Wells	West Virginia Department of Health and Human Resources	This dataset contains groundwater well information provided by West Virginia Department of Health and Human Resources.	As requested	N/A	N/A	N/A	N/A
WW USGS - USGS Water Wells	U.S. Geological Survey	This dataset contains groundwater well records from the U.S. Geological Survey.	Quarterly	06/30/2014	06/30/2014	07/13/2014	06/30/2014

Disclaimer *AEP Water Well Inventory*



The Banks Environmental Data Water Well Report was prepared from existing state water well databases and/or additional file data/records research conducted at the state agency and the U.S. Geological Survey. Banks Environmental Data has performed a thorough and diligent search of all groundwater well information provided and recorded. All mapped locations are based on information obtained from the source. Although Banks performs quality assurance and quality control on all research projects, we recognize that any inaccuracies of the records and mapped well locations could possibly be traced to the appropriate regulatory authority or the actual driller. It may be possible that some water well schedules and logs have never been submitted to the regulatory authority by the water driller and, thus, may explain the possible unaccountability of privately drilled wells. It is uncertain if the above listing provides 100% of the existing wells within the area of review. Therefore, Banks Environmental Data cannot fully guarantee the accuracy of the data or well location(s) of those maps and records maintained by the regulatory authorities.

APPENDIX C

Photographic Log



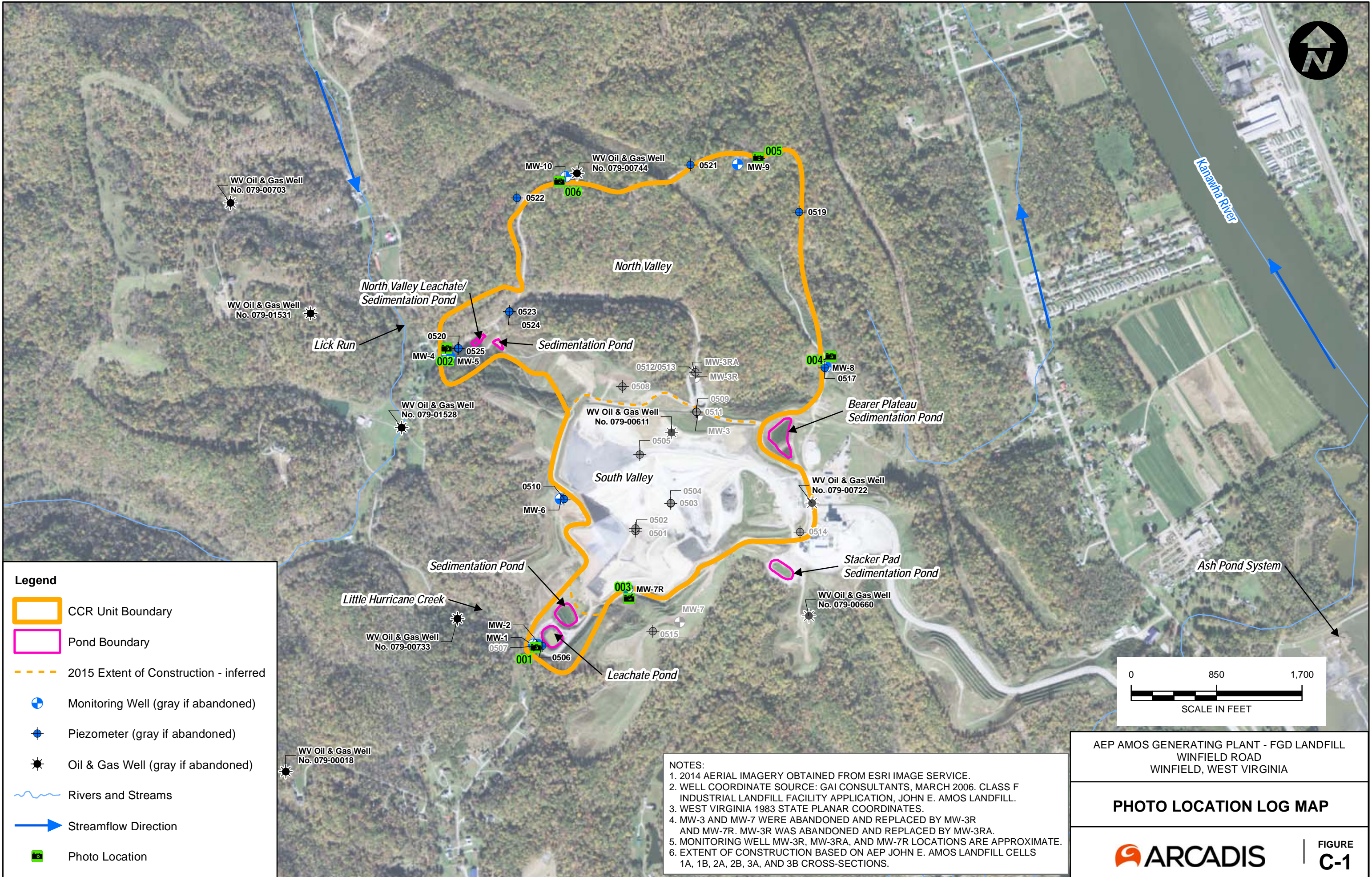

Legend

- CCR Unit Boundary
- Pond Boundary
- 2015 Extent of Construction - inferred
- Monitoring Well (gray if abandoned)
- Piezometer (gray if abandoned)
- Oil & Gas Well (gray if abandoned)
- Rivers and Streams
- Streamflow Direction
- Photo Location

NOTES:

- 2014 AERIAL IMAGERY OBTAINED FROM ESRI IMAGE SERVICE.
- WELL COORDINATE SOURCE: GAI CONSULTANTS, MARCH 2006. CLASS F INDUSTRIAL LANDFILL FACILITY APPLICATION, JOHN E. AMOS LANDFILL.
- WEST VIRGINIA 1983 STATE PLANAR COORDINATES.
- MW-3 AND MW-7 WERE ABANDONED AND REPLACED BY MW-3R AND MW-7R. MW-3R WAS ABANDONED AND REPLACED BY MW-3RA.
- MONITORING WELL MW-3R, MW-3RA, AND MW-7R LOCATIONS ARE APPROXIMATE.
- EXTENT OF CONSTRUCTION BASED ON AEP JOHN E. AMOS LANDFILL CELLS 1A, 1B, 2A, 2B, 3A, AND 3B CROSS-SECTIONS.

AEP AMOS GENERATING PLANT - FGD LANDFILL
WINFIELD ROAD
WINFIELD, WEST VIRGINIA

PHOTO LOCATION LOG MAP

ARCADIS | **FIGURE C-1**

City: CITRIX Div/Group: I/MDV Created By: K.Ives Last Saved By: webb
OH:015976.0009.0001 (Mountainview Ash Pond)
Z:\GIS\PROJECTS\ENV\AEP\amos\mxd\Landfill Report\C1_PhotoLocations\..._aerial.mxd 8/16/2016 9:30:01 AM

Photo No. 001	Date: 8/11/2015
Direction Photo Taken: Northeast	
Description: Wells MW-1 and MW-2 west of the Leachate Pond.	

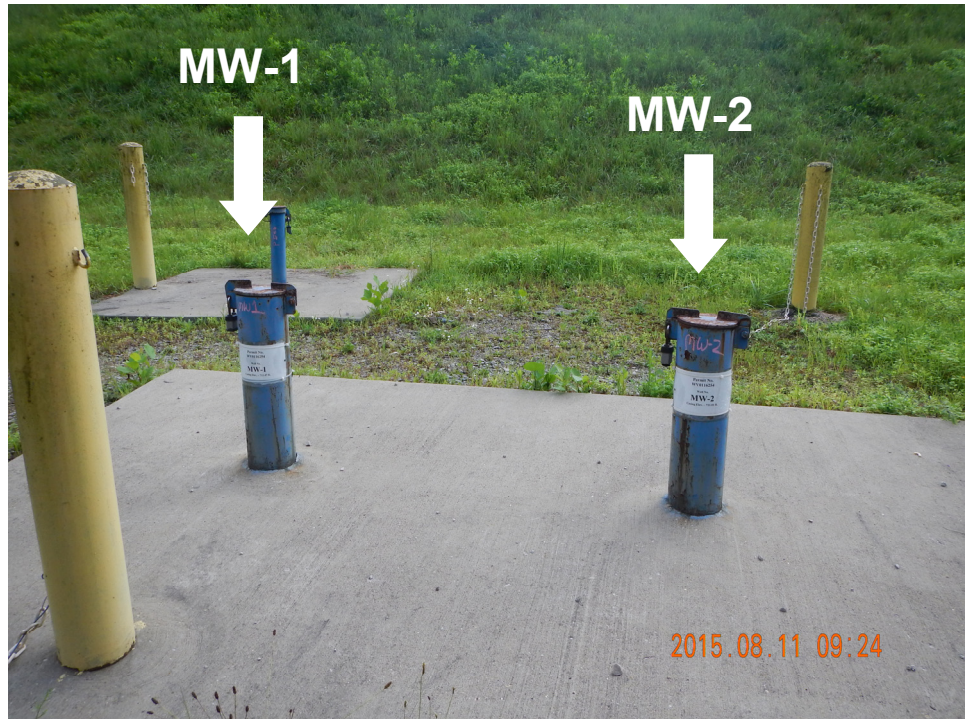

Photo No. 002	Date: 8/11/2015
Direction Photo Taken: South	
Description: Wells MW-4 and MW-5 southwest of the Sedimentation Pond.	



Photo No. 003	Date: 8/11/2015
Direction Photo Taken: South	
Description: Well MW-7R northeast of the Sedimentation Pond.	



Photo No. 004	Date: 8/11/2015
Direction Photo Taken: Northwest	
Description: Well MW-8 northeast of the Stormwater Pond.	



Photo No. 005	Date: 8/11/2015
Direction Photo Taken: North	
Description: Well MW-9 north of the Stormwater Pond.	



Photo No. 006	Date: 8/11/2015
Direction Photo Taken: North	
Description: Well MW-10 northeast of the Sedimentation Pond.	

